



## Artisan Technology Group is your source for quality new and certified-used/pre-owned equipment

- FAST SHIPPING AND DELIVERY
- TENS OF THOUSANDS OF IN-STOCK ITEMS
- EQUIPMENT DEMOS
- HUNDREDS OF MANUFACTURERS SUPPORTED
- LEASING/MONTHLY RENTALS
- ITAR CERTIFIED SECURE ASSET SOLUTIONS

### SERVICE CENTER REPAIRS

Experienced engineers and technicians on staff at our full-service, in-house repair center

### *InstraView*<sup>SM</sup> REMOTE INSPECTION

Remotely inspect equipment before purchasing with our interactive website at [www.instraview.com](http://www.instraview.com) ↗

### WE BUY USED EQUIPMENT

Sell your excess, underutilized, and idle used equipment. We also offer credit for buy-backs and trade-ins. [www.artisanng.com/WeBuyEquipment](http://www.artisanng.com/WeBuyEquipment) ↗

### LOOKING FOR MORE INFORMATION?

Visit us on the web at [www.artisanng.com](http://www.artisanng.com) ↗ for more information on price quotations, drivers, technical specifications, manuals, and documentation

**Contact us:** (888) 88-SOURCE | [sales@artisanng.com](mailto:sales@artisanng.com) | [www.artisanng.com](http://www.artisanng.com)



## L'UNITE SEALED COMPRESSORS - INTRODUCTION



L'Unite Hermetique is 100% owned by Tecumseh, USA. Hermetic compressors are manufactured in Europe and marketed by Tecumseh Europe.

Where applicable all L'Unite compressors come complete with full electrics and rotalock valves included in cost. FH - TFH - TAG & \*TAGD compressors come complete with crankcase heaters and oil level sight glasses. NB. A/C compressors may not have accessories attached.

### Merits of TAGD

- capacity control according to the system demands
- reduced energy consumption due to low torque start and sequence starting
- reduced number of starts.

### Terminology

LT (LBP)	Low Temperature - Evaporating Temp Range -40°C / -10°C
HT (HBP)	High Temperature - Evaporating Temp Range -15°C / +15°C
HT W (M/HBP)	High Temperature Wide Range - Evaporating Temp Range -25°C / +15°C
AC	Air Conditioning - Evaporating Temp Range -10°C / +10°C
S/F	Static Cooled/Fan Cooled
F	Fan Cooled
SOC	Static with oil cooler
CAP	Capillary Controlled
CAP/TEV	Capillary or Expansion Valve Controlled

### For suitable compressor oils, please see Lubricants Section

M	Mineral Oil
AB	Alkylbenzene Oil
P	Polyolester Oil

**Warranty:** See Warranty section at front of catalogue for more details.

### TECUMSEH EUROPE RATING CONDITIONS

Applications	Ambient	Evaporator outlet and return gas super heated	Condensing	Entering exp. valve
Low Temperature domestic and commercial refrigeration (LBP)	+32°C	+32°C	+54.5°C	+32°C
Other Applications (M/HBP-AC)	+35°C	11K	+54.5°C	+46,1°C



Visit [www.tecumseh-europe.com](http://www.tecumseh-europe.com) for additional product information.



**L'UNITE SEALED COMPRESSORS**

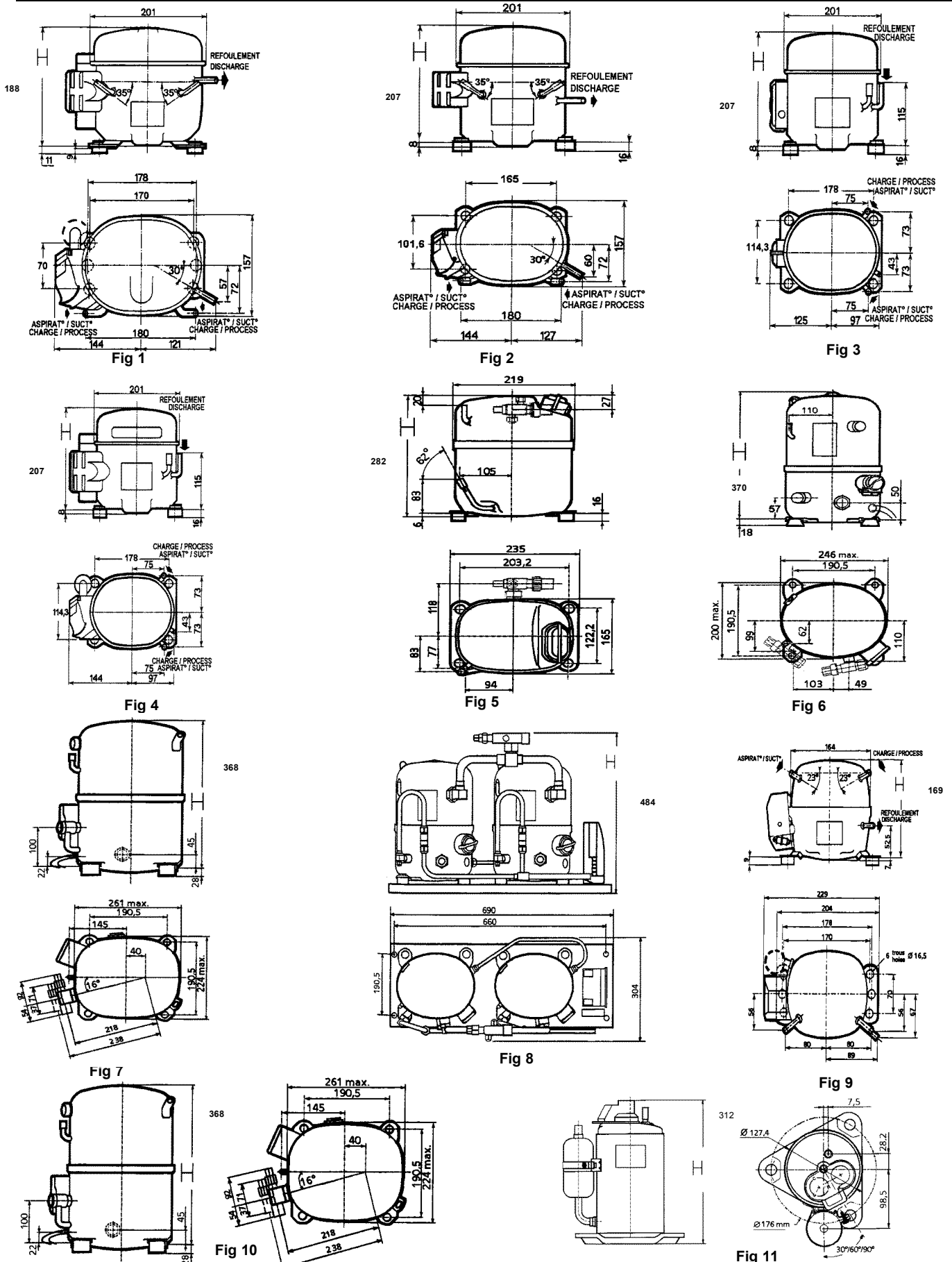

Specified compressor heights are indicative of series dimensions. Certain model heights vary from specification. Please consult RE if the compressor height is crucial.



Visit [www.tecumseh-europe.com](http://www.tecumseh-europe.com) for additional product information.

POA = PRICE ON APPLICATION OR REQUEST



# L'UNITE SEALED RECIPROCATING COMPRESSORS – R404A

## L'UNITE SEALED R404A

REALCOLD STOCK NO.	MODEL	FIG	NOM. HP	APPL	WATTS						D cm <sup>3</sup>	OC L	Price Excl GST Each
					-15°C	-10°C	-5°C	0°C	+7.2°C	+15°C			

Column Key: D = Displacement, OC = Oil Charge, FIG = Picture # Control = Cap/TEV for all models listed

### DOMESTIC – COMMERCIAL 220/240 Volt 50 Hz Single Phase

C7010	AEZ4425Z	Fig 1	1/5	HT	198	263	341	432	587	787	4.50	.45	POA
C7012	AEZ4430Z	Fig 1	1/4	HT	258	346	441	550	741	1010	5.70	.45	
C7014	AEZ9440Z	Fig 3	1/3	HTW	357	462	590	743	1004	1342	7.55	.45	
C7016	CAE9450Z	Fig 3	3/7	HTW	434	567	731	927	1270	1729	9.40	.45	
C7020	CAE9460Z	Fig 3	1/2	HTW	546	711	908	1141	1545	2086	11.30	.45	
C7021	CAE9470Z	Fig 3	1/2	HTW	669	869	1109	1392	1878	2514	13.30	.45	
C7022	CAJ9480Z	Fig 5	5/8	HTW	774	1009	1284	1607	2172	2943	15.20	.89	
C7030	CAJ9510Z	Fig 5	1.0	HTW	970	1252	1583	1972	2650	3563	18.30	.89	
C7032	CAJ9513Z	Fig 5	1.1/8	HTW	1114	1501	1955	2485	3406	4646	24.20	.89	
C7036	CAJ4517Z	Fig 5	1.1/4	HT	1364	1776	2273	2857	3860	5173	25.95	.89	
C7038	CAJ4519Z	Fig 5	1.1/2	HT	1769	2353	3009	3756	5030	6735	34.45	.89	
*C7040	FH4524Z	Fig 6	2.0	HT	1964	2639	3395	4249	5682	7557	43.50	1.33	
*C7042	FH4531Z	Fig 6	2.1/2	HT	2449	3477	4505	5573	7266	9433	56.65	1.33	

\*C7040 and C7402 are available both single and three phase – please state when ordering.

### COMMERCIAL 400 Volt 50 Hz Three Phase

*C7048	TFH4522Z	Fig 6	1.3/4	HT	1718	2303	2970	3734	5036	6761	39.95	1.33	POA
*C7050	TFH4524Z	Fig 6	2.0	HT	1964	2639	3395	4249	5682	7557	43.50	1.33	
*C7054	TFH4531Z	Fig 6	2.5	HT	2449	3477	4505	5573	7266	9433	56.65	1.33	
*C7058	TFH4540Z	Fig 6	3.0	HT	3445	4486	5635	6912	9013	11696	74.25	1.33	
*C7070P^	TAG4553Z	Fig 7	4.5	HT	3868	5306	6957	8865	12151	16563	100.70	1.96	
*C7074P^	TAG4561Z	Fig 7	5.0	HT	4560	6133	7914	9953	13438	18100	112.50	1.96	
*C7082P^	TAG4573Z	Fig 7	6.1/4	HT	6155	8000	10122	12567	16755	22327	134.80	1.96	

REALCOLD STOCK NO.	MODEL	FIG	NOM. HP	APPL	WATTS						D cm <sup>3</sup>	OC L	Price Excl GST Each
					-35°C	-30°C	-23.3°C	-20°C	-15°C	+10°C			

### COMMERCIAL 220/240 Volt 50 Hz Single Phase

C0532	AEZ2415Z	Fig 1	3/8	LT	160	231	355	429	556	703	8.10	.45	POA
C0545	CAE2417Z	Fig 3	1/2	LT	161	280	460	557	716	891	11.30	.45	
C0551	CAE2420Z	Fig 4	1/2	LT	232	357	547	654	836	1047	12.54	.45	
C0554	CAE2424Z	Fig 3	5/8	LT	291	442	664	783	981	1199	15.00	.45	
C0573	CAJ2432Z	Fig 5	3/4	LT	318	510	792	950	1227	1560	18.30	.89	
C0580	CAJ2446Z	Fig 5	1	LT	549	797	1194	1423	1821	2290	26.15	.89	
C0592	CAJ2464Z	Fig 5	1.1/2	LT	723	1076	1605	1902	2412	3012	34.45	.89	
*C0599	FH2480Z	Fig 6	2	LT	738	1319	2183	2662	3476	4419	53.20	1.625	

### COMMERCIAL 400 Volt 50 Hz Three Phase

*C7120	TFH2480Z	Fig 6	2.0	LT	738	1319	2183	2662	3476	4419	53.4	1.625	POA
*C7122P^	TFH2511Z	Fig 6	3.0	LT	1380	2016	3135	3796	4931	6222	74.3	1.625	
*C7126P^	TAG2516Z	Fig 7	4.0	LT	1743	2704	4356	5335	7043	9038	112.5	1.96	
*C7128P^	TAG2522Z	Fig 7	5.0	LT	2378	3542	5522	6688	8711	11062	134.8	1.96	

All above compressors use Polyolester Oil and require fan cooling.

Refer to Realcold Technical Department for Tandem Compressor packages up to 12HP.

\* These items include crankcase heater and oil sight glass.

P^ These items include an oil level sight glass and connections for oil and pressure equalising lines.



**Use Acid-Away to solve burn-out and acid build up situations.**



Visit [www.tecumseh-europe.com](http://www.tecumseh-europe.com) for additional product information.



**L'UNITE SEALED RECIPROCATING COMPRESSORS  
R22 GREENLINE**

REALCOLD STOCK NO.	MODEL	FIG	NOM HP	APPL	WATTS						D cm <sup>3</sup>	OC L	Price Excl GST Each
					-15°C	-10°C	-5°C	0°C	+7.2°C	+15°C			

Column Key: D = Displacement, OC = Oil Charge, C = Cooling Control = Cap/TEV for all models listed FIG = Picture # on page C20

**R22 DOMESTIC – COMMERCIAL 220/240 Volt 50 Hz Single Phase**

C0320	AEZ4425E	Fig 3	1/5	HT	192	256	329	413	553	728	4.50	.45	POA
C0325	AEZ4430E	Fig 1	1/4	HT	255	336	430	538	718	945	5.70	.45	
C0333	AEZ4440E	Fig 1	1/3	HT	362	464	588	733	980	1298	7.55	.45	
C0339	CAE4450E	Fig 4	3/8	HT	426	554	710	896	1212	1623	9.40	.45	
C0351	CAE9460T	Fig 3	1/2	HTW	553	715	909	1134	1514	2000	11.30	.45	
C0360	CAJ9480T	Fig 5	5/8	HTW	786	1011	1278	1586	2103	2761	15.20	.89	
C0375	CAJ9510T	Fig 5	1.0	HTW	956	1229	1547	1909	2510	3266	18.30	.89	
C0390	CAJ9513T	Fig 5	1.1/8	HTW	1074	1451	1896	2411	3272	4366	24.20	.89	
C0392	CAJ4517E	Fig 5	1.1/4	HT	1233	1673	2171	2727	3629	4743	25.95	.89	
C0393	FH4522F	Fig 6	1.3/4	HT	1598	2202	2927	3774	5206	7042	39.95	1.33	
C0395	FH4524F	Fig 6	2.0	HT	1841	2456	3219	4131	5706	7759	43.50	1.33	
C0397	FH4531F	Fig 6	2.½	HT	2620	3504	4517	5659	7528	9854	56.65	1.33	

All above compressors use Mineral oil and require fan cooling.

**AIR CONDITIONING R22 220/240 Volt 50 Hz Single Phase**

Rated in Watts at +7.2°C SST/+54.5°C SCT, for capillary use only

REALCOLD STOCK NO.	MODEL	FIG	WATTS	D cm <sup>3</sup>	OT	OC L	C	Price Excl GST Each
C0110	AJ5510F	Fig 5	2447	18.60	M	.89	F	POA
C0111	AJ5512E	Fig 5	2909	21.75	M	.89	F	
C0123	AJ5513E	Fig 5	3213	24.20	M	.89	F	
C0124	AJ5515E	Fig 5	3631	25.95	M	.89	F	
C0126	AJ5518E	Fig 5	4563	32.70	M	.89	F	
C0127	AJ5519E	Fig 5	4779	34.45	M	.89	F	
C0129	FH5524F	Fig 6	5929	43.50	M	1.33	F	
C0138	FH5528F	Fig 6	6811	49.00	M	1.33	F	

**SEALED ROTARY COMPRESSORS**

**L'UNITE SEALED R22 220/240 volt 50Hz Single Phase**

REALCOLD STOCK NO.	MODEL	FIG	WATTS	D cm <sup>3</sup>	OT	OC L	C	Price Excl GST Each
C7210	RK5512E	Fig 11	2771	16.3	M	0.422	F	POA
C7216	RK5515E	Fig 11	3601	21.4	M	0.452	F	
C7218	RK5518E	Fig 11	4196	24.4	M	0.452	F	



Try Acid-Away today– your solution for burn outs and acid build up!



Visit [www.tecumseh-europe.com](http://www.tecumseh-europe.com) for additional product information.

**L'UNITE SEALED RECIPROCATING COMPRESSORS - R134a GREENLINE**

REALCOL D STOCK NO.	MODEL	FIG	NOM HP	APP	WATTS						D cm <sup>3</sup>	OC L	C	CONTROL	PRICE excl GST each
					-35°C	-30°C	-23.3°C	-20°C	-15°C	-10°C					
<b>DOMESTIC - COMMERCIAL 220/240 Volt 50 Hz Single Phase</b>															
C0501	AZ1335Y	Fig 9	1/8	LT	42	58	89	108	141	180	4.0	.40	S	Cap	POA
C0502	AZ1339Y	Fig 9	1/7	LT	40	63	104	129	171	220	5.0	.27	S	Cap	
C0506	AZ1355Y	Fig 9	1/5	LT	58	88	140	170	223	284	5.9	.30	S	Cap	
C0522	AEZ2380Y	Fig 2	1/4	LT	94	144	223	267	338	417	9.4	.45	soc	Cap/TEV	
C0530	CAE2410Y	Fig 4	1/3	LT	92	151	259	324	436	566	12.05	.45	F	Cap/TEV	
C0534	CAE2412Y	Fig 4	3/8	LT	96	174	306	383	514	663	14.15	.45	F	Cap/TEV	
REALCOL D STOCK NO.	MODEL	FIG	NOM. HP	APP	WATTS						D cm <sup>3</sup>	OC L	C	CONTROL	Price Excl GST Each
					-15°C	-10°C	-5°C	0°C	+7.2°C	+15°C					
<b>COMMERCIAL 400 Volt 50 Hz Three Phase</b>															
**C0594*	TFH4518Y	Fig 6	1.1/2	HT	1036	1650	2371	3200	4583	6333	53.20	1.33	F	Cap/TEV	POA
**C0596*	TFH4525Y	Fig 6	2	HT	1667	2343	3201	4239	6053	8442	74.25	1.33	F	Cap/TEV	

All above compressors use Polyolester oil. \* Please state option when ordering, ie 1 phase or 3 phase.

\*\* Includes crankcase heater.

**L'UNITE SEALED RECIPROCATING COMPRESSORS- R12 LOW TEMPERATURE**

REALCOL D STOCK NO.	MODEL	FIG	NOM HP	APP	WATTS						D cm <sup>3</sup>	OC L	C	CONTROL	PRICE excl GST each
					-35°C	-30°C	-23.3°C	-20°C	-15°C	-10°C					
<b>COMMERCIAL 220/240 Volt 50 Hz Single Phase</b>															
C0058	CAJ2T12	Fig 5	1/2	LT	255	386	613	746	976	1239	26.15	.89	F	CAP/TEV	POA



Try Acid-Away today-- your solution for burn outs and acid build up!

WEB  
LINK



Visit [www.tecumseh-europe.com](http://www.tecumseh-europe.com) for additional product information.

**C12**

February 2007



L'UNITE  
HERMETIQUE

**L'UNITE SEALED TANDEM COMPRESSOR KIT COMMERCIAL MEDIUM TEMP**

L'UNITE TAGD TWIN COMPRESSORS R22/R404A 400 Volt 50Hz Three Phase								
REALCOLD STOCK NO.	MODEL	WATTS @ -5°C SCT		D cm <sup>3</sup>	OT	OC L	C	Price Excl GST Each
		R22	R404a					
C7105	TAGD4612Z	21066	17760	225.0	POE	1.96	F	POA

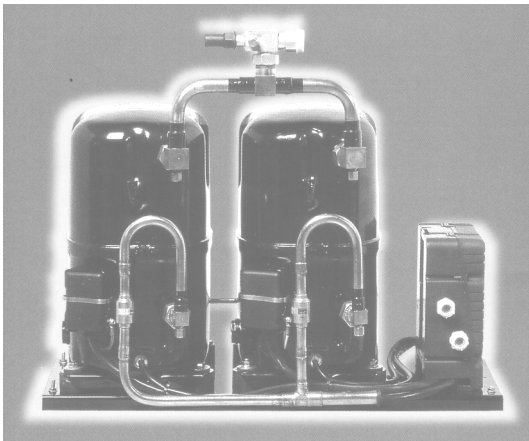

**Features of the Tandem System**

- Twin compressor configuration enable a more precise control of the system capacity to match the cooling demand and thereby the number of starts to a minimum to improve reliability.
- Capacity control - cycle one compressor off at low load conditions for power saving.
- Sequence start up of compressors reducing start up current.
- 50% redundant capacity in the event of one compressor failing.



*Try Acid-Away today– your solution for burn outs and acid build up!*



Visit [www.tecumseh-europe.com](http://www.tecumseh-europe.com) for additional product information.

POA = PRICE ON APPLICATION OR REQUEST



# C13

February 2007

## L'UNITE SEALED COMPRESSOR ACCESSORIES



### L'UNITE SEALED

REALCOLD STOCK NO.	DESCRIPTION	PRICE \$ excl GST
C1900	Terminal box cover to suit AEZ compressor	POA
C1901	Overload cover to suit CAJ compressor	
C1902	Terminal box to suit CAJ compressor	
C1903	Electrical Box for TAGD Packs	
C1930	Sight Glass Kit to suit FH, TFH, TAG & TAN compressors	

### ROTALOCK VALVES

REALCOLD STOCK NO.	MODEL	DESCRIPTION	PRICE \$ excl GST	
C1922	8.683.063	1/4 OD -suits UL-Listed L'Unite Receivers (was 683067)	POA	
C1923	8.683.068	3/8 OD -suits UL-Listed L'Unite Receivers (was 683067)		
C1908	8.683.060	1/4 OD -suits CE L'Unite Receivers		
C1909	8.683.053	3/8 OD -suits CE L'Unite Receivers		
C1911	8.683.049	1/2 OD -suits FH/TFH/CAJ/TAJ		
C1912	8.682.059	5/8 OD -suits CAJ/TAJ		
C1913	660062	5/8 OD -suits FH/TFH/TAG		
C1914	660066	3/4 OD -suits TAN		
C1916	660063	7/8 OD -suits CAH/TAH/TAG		
C1917	660064	1.1/8 OD -suits TAG/TAH		
<ul style="list-style-type: none"> <li>Teflon Seal 11.1 mm x 14.3 mm # H1103 in valve section</li> <li>Teflon Seal 15.9 mm x 19.1 mm # H1104 in valve section</li> <li>Teflon Seal 22.2 mm x 25.4 mm # H1105 in valve section</li> </ul>				

### CRANKCASE HEATERS

REALCOLD STOCK NO.	MODEL	DESCRIPTION	PRICE \$ excl GST
C1001	H-101	54 W 240 Volt Suitable for <b>L'Unite</b> AH and TAH compressors Suitable for <b>Kirby</b> AH, AG and CL compressors	POA
C1003	H-102	60W 240 Volt Suitable for <b>L'Unite</b> AJ and CAJ compressors Suitable for <b>Kirby</b> AJ compressors	
C1005		Crankcase Heater to suit FH, TFH & TAG Series	
C1007		Crankcase Heater to suit TAN Series - 2 per kit	

#### MAXIMUM TORQUE SETTINGS

##### Valve Spindle

- Small Valves	11.7	(115)
- 19mm square body	14	(138)
- 22mm square body	21	(207)
- 28mm square body	35	(344)

##### Valve cap on Rotalock

- 1/4" (7/16" thread)	14	(138)
- 3/8" (5/8" thread)	30.5	(300)
- 1/2" (3/4" thread)	45	(442)
- 3/4" (7/8" thread)	59	(580)

##### Rotalock valves on compressors and receivers (with joint)

- 3/4" thread	56.5	(553)
- 1" thread	84.5	(829)
- 1 1/4" thread	141	(1382)
- 1 1/2" thread	197	(1935)
- 1 3/4" thread	317	(3110)

##### Connections on parallel mounted versions

- 1 3/4" thread	107	(1050)
- 5/8" thread	45	(442)

##### Sight Glass

- 1 1/8"	51	(500)
----------	----	-------



Visit [www.tecumseh-europe.com](http://www.tecumseh-europe.com) for additional product information.





## SUPCO SEALED COMPRESSOR ACCESSORIES

### SOLID STATE RELAYS

REALCOLD STOCK NO.	MODEL	DESCRIPTION	HP/VOLTAGE	PRICE \$ excl GST
C4000	ICG 220	220 V Solid State Relay	1/12 HP through 1/2 HP	POA
C4005	PO 230	230 V Solid State Relay	1/12 HP through 1/2 HP	
C4020	RO-82	220 V Relay & Overload	1/12, 1/10, 1/8 HP	
C4015	RO-62	220 V Relay & Overload	1/6, 1/5 HP	
C4010	RO-42	220 V Relay & Overload	1/4, 1/3 HP	
C4025	RSC-20	220 V Solid State Start Relay & Capacitor (43 - 52MFD)		
C4030	RCO-820	230 V 3 n' 1 Start Relay	1/12, 1/10, 1/8 HP	
C4035	RCO-620	230 V 3 n' 1 Start Relay	1/6, 1/5 HP	
C4040	RCO-420	230 V 3 n' 1 Start Relay	1/4, 1/3 HP	
C4050	SPP-5	230 V Starter Pow-R-Pak	PSG A/C 4000-120000 BTU	
C4062	APR-5	Universal Replacement Relay	Pick up voltage 130V-370V	



RO



RSC



RCO



RO



### APPLICATIONS FOR SOLID STATE RELAYS

<b>ICG Series:</b>	<ul style="list-style-type: none"> <li>• One size for all compressors 1/12 through 1/2 HP.</li> <li>• Will replace most current relays.</li> <li>• Can be used with or without start capacitor.</li> </ul>
<b>PO Series:</b>	<ul style="list-style-type: none"> <li>• One size for all compressors 1/12 through 1/2 HP.</li> <li>• Replaces all push-on current type relays.</li> <li>• For use on compressors with "pin type" terminals.</li> <li>• Can be used on all capacitor and non-capacitor start motors.</li> <li>• Lowest resistance solid state relay.</li> <li>• Will restart a balanced system within one minute.</li> </ul>
<b>RO Series:</b>	<ul style="list-style-type: none"> <li>• Relay and overload in one combination unit.</li> <li>• Pre-wired for fast, simple installation.</li> <li>• Superior locked rotor protection eliminates start winding overheating.</li> <li>• Replaces all hermetic compressor relay and overload units 1/12 through 1/3 HP.</li> <li>• Can be used in conjunction with a start capacitor.</li> </ul>
<b>RSC Series:</b>	<ul style="list-style-type: none"> <li>• One size for all compressors 1/12 through 1/2 HP both domestic and commercial.</li> <li>• A combined solid state starting relay and capacitor.</li> <li>• Completely pre-wired.</li> <li>• Replaces current type relays.</li> <li>• Provides added boost for hard start and unbalanced systems.</li> <li>• Prevents low voltage starting problems. (No additional wires required.)</li> </ul>
<b>RCO Series:</b>	<ul style="list-style-type: none"> <li>• The 3 n' 1 Start Relay replaces all three electrical components, Relay, Overload, and Start Capacitor, on all capillary systems.</li> <li>• Completely pre-wired.</li> <li>• Installs quickly and easily, simply by pushing on 3 female pin terminals.</li> </ul>

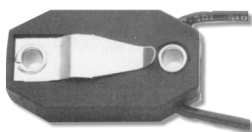

ICG

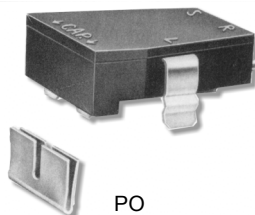

PO

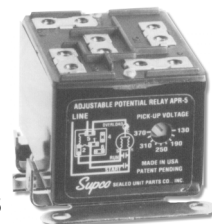

APR5



## FRASCOLD SEMI SEALED COMPRESSORS - INTRODUCTION



### Frascold History

The Fraschini Company was founded in 1936 to produce open drive compressors. Renamed Frascold in 1965, the company continued to develop its range of open drive compressors, adding a semi-hermetic reciprocating range by 1975. Since 1987 the factor production line has been continually upgraded with computer controlled machining processes, and this has enabled Frascold to increase production and maintain very high manufacturing standards. Quality control procedures conform to EN ISO 9001 standard.

Frascold's initiative and technology has led to the development of its low clearance high capacity design, where the piston head is shaped to suit the suction valve reed profile. This results in very low clearance, which is a major factor in improving performance and efficiency in respect to standard compressors.

The process of continual improvements has made Frascold a world leader as a manufacturer and supplier of semi-hermetic compressors throughout the world. Its modern, high performance range of semi-hermetic compressors is suitable for Refrigeration and Air Conditioning applications. Ranging from 3.93 cubic metres per hour through to 205.80 cubic metres per hour and with refrigeration capacities from 200 watts through to 280,000 watts, Frascold's semi-hermetic compressors are able to run on a large range of modern refrigerants.

### Notes on the Frascold Range

Please note that the superheat of the suction vapour entering the compressor must not exceed the values stated by the manufacturer. Failure to adhere to this will void any warranty or performance claims.

#### Evaporating Range – Guideline Only

All compressors are suction vapour cooled. Refer to Compressor Data Book for individual operating ranges for above compressors.

H +10°C/0°C                      M 0°C/-15°C                      L -15°C/-30°C

See Warranty section at the front of catalogue for Warranty details

Single Phase: Protection with thermal Klixon.  
 Three Phase: Inherent protection, thermistor with control relay.

**All Frascold compressors are charged with Polyolester oils. Please refer to our Technical Department for refrigerant blend applications.**

Our Technical Department is only too happy to select equipment and provide quotations for all your requirements.

Refer to Spares Section at the rear of this catalogue, for Frascold Compressor Spares.

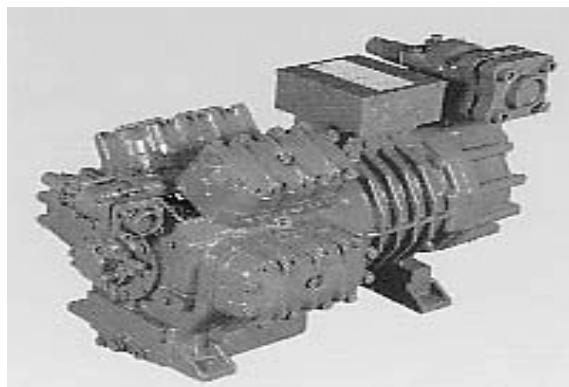



## SEMI-SEALED RECIPROCATING COMPRESSORS

### FRASCOLD SEMI SEALED

REALCOLD STOCK NO	MODEL (COMP)	HP/KW NOM.	DISP. M <sup>3</sup> /HR	OIL CHARGE LITRES	APPLICATION			PRICE \$ excl GST
					R22	R404a	R134a	
<b>Single Phase 220/240 Volt 50 Hz</b>								
C5016	A16	1.0/0.75	5.47	1.25	ML	ML	HM	POA
C5033	A157	1.5/1.1	6.91	1.25	ML	ML	HM	
C5038	B159	1.5/1.1	8.96	1.25	L	ML	HM	

### Three Phase 380/415 Volt 50 Hz

C5031	A157	1.5/1.1	6.91	1.25	ML	ML	HM	POA
C5036	B159	1.5/1.1	8.96	1.25	L	ML	HM	
C5046	B210	2.0/1.5	9.84	1.25	HML	ML	HM	
C5051	D213	2.0/1.5	13.84	1.50	ML	L	HM	
C5061	D313	3.0/2.2	13.84	1.50	HML	ML	HM	
C5071	D318	3.0/2.2	17.93	1.50	L	L	HM	
C5078	D418	4.0/3.0	17.93	1.2	HML	ML	HM	
C5086	F424	4.0/3.0	23.60	2.60	L	L	HM	
C5095	F524	5.0/3.7	23.60	2.60	HML	ML	HM	
C5096	Q528Y	5.0/3.7	27.88	1.8	ML	L	HM	
C5097	Q533Y	5.0/3.7	32.66	1.8	ML	L	HM	
C5098	Q728	7.5/5.5	27.31	2.60	HML	ML	HM	
C5124	S733	7.5/5.5	32.80	3.30	HML	ML	HM	
C5127	S739	7.5/5.5	38.25	3.30	L	ML	HM	
C5129	S1039	10/7.5	38.25	3.30	HML	ML	HM	
C5133	S1051	10/7.5	50.43	3.30	ML	ML	HM	
C5137	S1551	15/11	50.43	3.30	HML	ML	HM	
C5155	V1559	15/11	58.48	4.25	ML	ML	HM	
C5160	V1571	15/11	70.77	4.25	L	L	HM	
C5165	V2059	20/15	58.84	4.25	HML	ML	HM	
C5172	V2084	20/15	83.81	4.25	ML	L	HM	
C5185	V2571	25/18.5	70.77	4.25	HM	HM	HM	
C5187	V25103	25/18.5	102.90	4.25	ML	L	HM	
C5192	V3084	30/22	83.81	4.25	HM	HM	HM	
C5198	Z30126	30/22	125.72	7.50	ML	L	HM	
C5200	Z35106	35/26	106.16	5.00	HML	ML	HM	
C5206	Z40126	40/30	125.72	7.50	HML	ML	HM	
C5210	Z40154	40/30	154.38	7.50	ML	ML	HM	
C5215	Z50154	50/37	154.38	7.50	HML	ML	HM	
C5233	W50187	50/37	186.10	8.00	ML	ML	HM	
C5234	W60187	60/44.5	186.10	8.00	HM	HM	HM	
C5235	W60206	60/44.5	205.80	8.00	ML	ML	HM	
C5238	W70206	70/52	205.80	8.00	ML	ML	-	

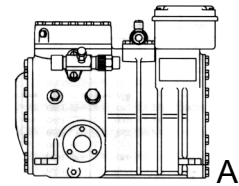

A

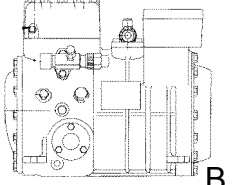

B

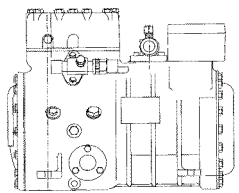

D

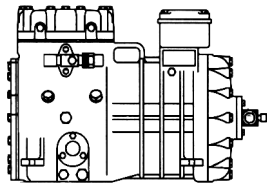

F

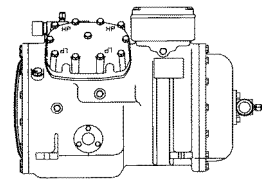

S

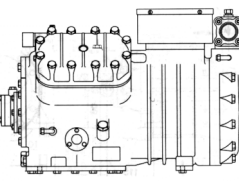

V

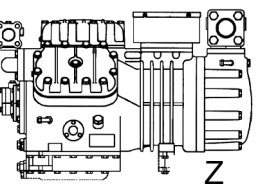

Z

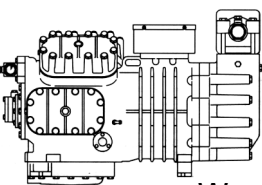

W

Realcold offer equipment selection services. Please feel free to use this service.  
**REFER TO SPARES SECTION AT REAR FOR FRASCOLD COMPRESSOR SPARES.**



Visit [www.frascold.com](http://www.frascold.com) for additional product information.

**SEMI-SEALED RECIPROCATING UNIT ACCESSORIES**
**CAPACITY CONTROL**

REALCOLD STOCK NO.	DESCRIPTION	PRICE \$ Excl GST
C5221	To suit "T" & "S" Series (Mk II) 1 cylinder head c/w solenoid 50% control	POA
C5225	To suit "Z" & "V" & "W" Series 1 head only. 1 head for "V"=50% control. 1 head for "Z" = 33% control 2 heads for "Z"=33% & 66% control (Z:33%+66% = 2 x C5225) 2 heads for "W"=50% & 75% control (W:50%+75% = 2 x C5225)	

**ACCESSORIES**

REALCOLD STOCK NO.	DESCRIPTION	POWER	FITTING	PRICE \$ Excl GST
R0316	Rubber Mounts 40 x 40 mm	2 - 3 HP		POA
R0552	Crankcase Heater F, S, T Series	70 Watt	Fitted	
R0553	Crankcase Heater A, B, D Series	50 Watt	Fitted	
R0555	Crankcase Heater (to suit V, W, Z Series) MK 2	150 Watt Plain Shank	Fitted	
C5805	Head Cooling Fan (to suit A, B, D, F Series)		Fitted	
C5808	Head Cooling Fan to suit S, T, V, Z Series		Fitted	
R0824	Delta-P Oil Differential Pressure Switch suits V, Z and W Series The Delta-P is easy and fast to mount, with no mounting bracket required. The electric component can be removed without refrigerant leakage. Includes a reset push button.			

**OGURA MAGNETIC CLUTCHES**

(suitable for Tecumseh, Blissfield, York)



REALCOLD STOCK NO.	MODEL	DIAMETER	VOLTS	DRIVE PROFILE	STATIC TORQUE	PRICE \$ excl GST
C0240	MA-6A	6"	12 Volt	Twin 'A' Section	72 ft lbs	POA
C0241	MA-7A	7"	12 Volt	Twin 'A' Section	72 ft lbs	
C0242	MA-7A	7"	24 Volt	Twin 'A' Section	72 ft lbs	
C0243	MA-6A	6"	24 Volt	Twin 'A' Section	72 ft lbs	

 WEB  
LINK

 Visit [www.frascold.com](http://www.frascold.com) for additional product information.



## SCREW COMPONENT INTRODUCTION

Frascold started manufacturing a range of twin screw compressors in 1995.

The twin screw compressor range comprises twenty four models across three ranges.

**C-TSH Range:** This range of compact twin screw compressors comprises eight models from a nominal 40HP to 120HP, with displacements from 120 to 360 cubic meters per hour at 50Hz. The C-TSH range is suited to applications in the operating temperature range from +12.5C to -15C SET on R22/ R407C/ R134A/ R404A. Compressors are fitted with integral oil separator / reservoir.

**R-TSH Range:** This range comprises eight models from nominal 40HP to 120HP, with displacements from 120 to 360 cubic meters per hour at 50Hz. The R-TSH range is suited to air conditioning and medium/ high temperature applications, in the temperature operating range from + 7.5C to - 20 C SET on R404A/R507A; +12.5C to -20C on R22; +20C to -10C on R134A.

**R-TSL Range:** This range comprises eight models from nominal 30HP to 100HP, with displacements from 120 to 360 cubic meters per hour at 50Hz. The R-TSL range is suited to low temperature applications, in the temperature operating range from -20C to -45C on R404A/ R507A.

### OUTSTANDING FEATURES

**Screw Profiles:** The compressors are two-shaft rotary displacement design, with innovative profiles of the screws.

(Ratio 5:6 between male & female screw). The shafts are fitted with large roller bearings sized to bear both radial and axial loads, resulting in reduction of friction, vibration and lower noise levels. Discharge check valve, located in the service valve prevents counter rotation when compressor stops operating.

**High Efficiency Electric Motor:** High efficiency electric motor is two-pole, three phase asynchronous type. The rotor is fitted to the shaft of the male screw. Cooling of the motor is carried out by the suction gas flowing through slots in the rotor, also causing any liquid refrigerant to be separated due to the centrifugal action.

Power Supply: 400/3/50

Connection: Part Winding Start (PWS) 50% + 50% current distribution

**Capacity Control:** All compressors are fitted with capacity control, which operates by means of a three-way solenoid valve, directing the flow of oil under pressure, to a slide piston mechanism. At full load, oil under pressure pushes against the piston, opposing the spring and closing the capacity control device. At reduced load conditions, the oil is diverted to the suction side of the compressor, and the spring forces the piston to open the capacity control device, which reduces the displacement and consequently reduces the capacity of the compressor.

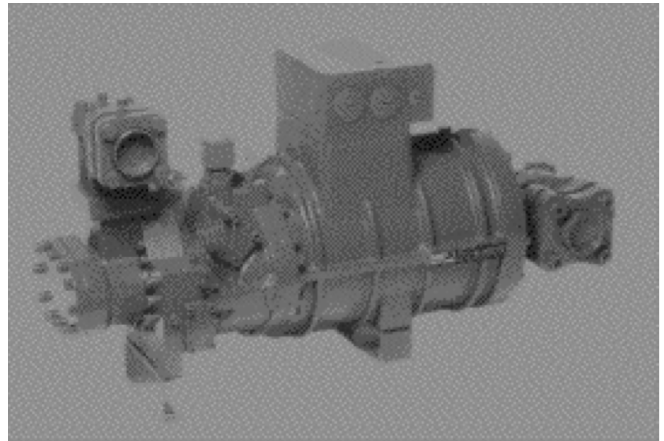

### CAPACITY CONTROL STEPS

Model Number	% of full capacity – Steps
R-TSH8 40 120Y; R-TSL8 30 120Y	100 – 50; one stage capacity control
R-TSH8 50 150Y; R-TSL8 40 150Y	100 – 50; one stage capacity control
R-TSH8 60 186Y; R-TSL8 50 186 Y	100 – 50; one stage capacity control
R-TSH8 70 210Y; R-TSL8 60 210Y	100 – 50; one stage capacity control
R-TSH8 80 240Y; R-TSL8 70 240Y	100-75-50; two stage capacity control
R-TSH8 90 270Y; R-TSL8 80 270Y	100-75-50; two stage capacity control
R-TSH8 100 300Y; R-TSL8 90 300Y	100-75-50; two stage capacity control
R-TSH8 120 360Y; R-TSL8 100 360Y	100-75-50; two stage capacity control

**Electronic Protection Device:** All screw compressors are equipped with electronic protection called KRIWAN NT 68 FRY, complete with thermistor sensors, performing the following functions:

- Control of maximum temperature of the electric motor +120C, through six PTC thermistors, fitted to the stator winding.
- Control of the maximum discharge temperature +120C through PTC sensor placed on compressor discharge side.
- Control of rotation direction of the electric motor and phase sequence.
- Protection of phase and voltage failures.
- Control of breakage and short circuit in chain of PTC sensors.

Screw compressors can be installed in parallel configurations and the R series are well suited to two-stage systems.



**SEMI-HERMETIC SCREW COMPRESSORS**

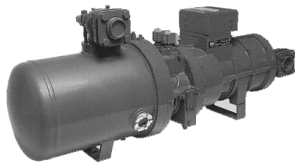

REALCOLD STOCK NO.	MODEL	DESCRIPTION	HP/KW	DISP m3/HR	Price Excl GST ea
<b>COMPACT TWIN SCREW COMPRESSOR</b>					
Medium Temperature					
C5251	C-TSH8 40 120Y	COMPRESSOR MBP-HBP	40/30	120	POA
C5252	C-TSH8 50 150Y	COMPRESSOR MBP-HBP	50/37	150	
C5253	C-TSH8 60 186Y	COMPRESSOR MBP-HBP	60/45	186	
C5254	C-TSH8 70 210Y	COMPRESSOR MBP-HBP	70/52	210	
C5255	C-TSH8 80 240Y	COMPRESSOR MBP-HBP	80/60	240	
C5256	C-TSH8 90 270Y	COMPRESSOR MBP-HBP	90/67	270	
C5257	C-TSH8 100 300Y	COMPRESSOR MBP-HBP	100/75	300	
C5258	C-TSH8 120 360Y	COMPRESSOR MBP-HBP	120/90	360	

Note that these Compressors are available as Indent stock

***i* Standard equipment**

Screw compressor is supplied complete with:

- oil separator directly assembled with flange to the compressor body
- oil demister inside the separator
- oil strainer
- discharge connection complete with valve and check valve
- suction valve
- internal relief valve
- capacity control device
- electronic protection device
- electric box with IP65 protection
- oil heater
- vibration absorbers

<b>TWIN SCREW COMPRESSORS</b>					
Medium Temperature					
C5261	R-TSH8 40 120Y	COMPRESSOR MBP	40/30	120	POA
C5262	R-TSH8 50 150Y	COMPRESSOR MBP	50/37	150	
C5263	R-TSH8 60 186Y	COMPRESSOR MBP	60/45	186	
C5264	R-TSH8 70 210Y	COMPRESSOR MBP	70/52	210	
C5265	R-TSH8 80 240Y	COMPRESSOR MBP	80/60	240	
C5266	R-TSH8 90 270Y	COMPRESSOR MBP	90/67	270	
C5267	R-TSH8 100 300Y	COMPRESSOR MBP	100/75	300	
C5268	R-TSH8 120 360Y	COMPRESSOR MBP	120/90	360	
Low Temperature					
C5271	R-TSL8 30 120Y	COMPRESSOR LBP	30/22	120	POA
C5272	R-TSL8 40 150Y	COMPRESSOR LBP	40/30	150	
C5273	R-TSL8 50 186Y	COMPRESSOR LBP	50/37	186	
C5274	R-TSL8 60 210Y	COMPRESSOR LBP	60/45	210	
C5275	R-TSL8 70 240Y	COMPRESSOR LBP	70/52	240	
C5276	R-TSL8 80 270Y	COMPRESSOR LBP	80/60	270	
C5277	R-TSL8 90 300Y	COMPRESSOR LBP	90/67	300	
C5278	R-TSL8 100 360Y	COMPRESSOR LBP	100/75	360	

Note that these Compressors are available as Indent stock only

***i* Standard equipment**

Standard equipment mounted on the compressor

- capacity control device
- integral electronic protection, includes:
  - sensor for maximum discharge temperature
  - sensor for maximum temperature of electric motor
  - electronic module
- suction valve
- discharge valve with check valve

Standard equipment supplied loose with compressor.

- vibration absorbers
- components for external oil piping, includes:
  - oil strainer with core
  - solenoid valve with coil and plug
  - oil flow switch
  - electronic module for oil flow switch
  - oil sight glass

POA = PRICE ON APPLICATION OR REQUEST



**SEMI-SEALED SCREW COMPRESSOR ACCESSORIES**

REALCOLD STOCK NO.	MODEL	DESCRIPTION	PRICE EXCL GST
C5820	TOOWK150	VISUAL INDICATOR	POA
C5822	TOOWK151	VISUAL INDICATOR	
C5824	SZ-WOC1	WATER COOLED OIL COOLER	
C5826	SZ-WOC2	WATER COOLED OIL COOLER	
C5828	SZ-WOC3	WATER COOLED OIL COOLER	
C5830	SZ-AOC1	AIR COOLED OIL COOLER	
C5832	SZ-AOC2	AIR COOLED OIL COOLER	
C5834	SZ-AOC3	AIR COOLED OIL COOLER	
C5836	TOOWK200	REMOTE OIL SEPARATOR	
C5838	TOOWK201	REMOTE OIL SEPARATOR	
C5840	TOOWK202	REMOTE OIL SEPARATOR	
C5842	TOOWK300	ECONOMIZER R22	
C5844	TOOWK301	ECONOMIZER R404A	
C5846	TOOWK302	ECONOMIZER R23	
C5848	TOOWK303	ECONOMIZER R404A	
C5850	TOOWK304	ECONOMIZER R24	
C5852	TOOWK305	ECONOMIZER R404A	
C5854	TOOWK306	ECONOMIZER R25	
C5856	TOOWK307	ECONOMIZER R404A	
C5858	TOOWK400	LIQUID INJECTION VALVE	
C5860	SZ-OIL1	FC300 19 LITRE OIL (M/T R404)	
C5862	SZ-OIL2	FC170 25 LITRE OIL (L/T, M/T R22)	
C5864	SZ-OIL3	FC170 19 LITRE OIL (L/T R404A)	

This equipment is available on an indent basis only

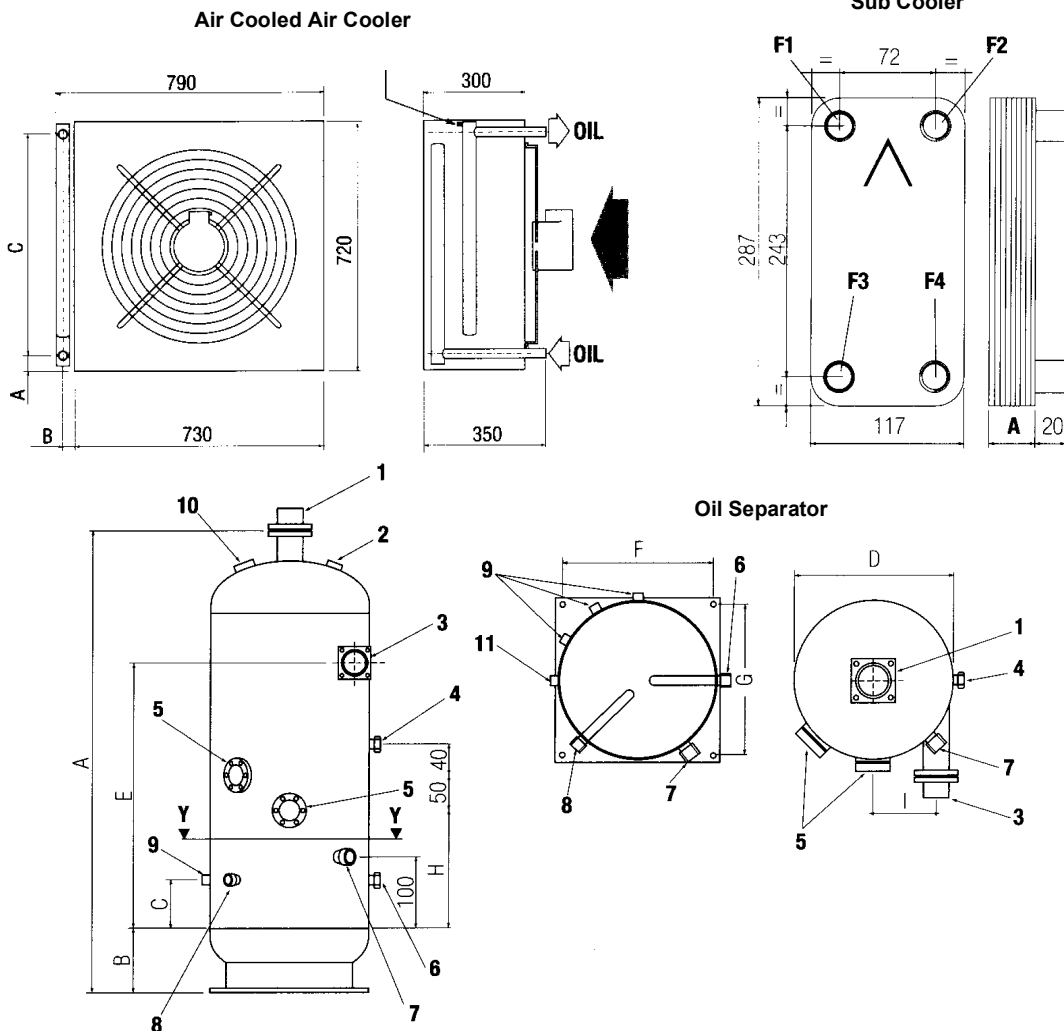

POA = PRICE ON APPLICATION OR REQUEST



**SEMI-SEALED SCREW COMPRESSOR ACCESSORIES**

	Compressor Model															
	R-TSH1 40 120 Y	R-TSH1 50 150 Y	R-TSH1 60 186 Y	R-TSH1 70 210 Y	R-TSH1 80 240 Y	R-TSH1 90 270 Y	R-TSH1 100 300 Y	R-TSH1 120 360 Y	R-TSL1 30 120 Y	R-TSL1 40 150 Y	R-TSL1 50 186 Y	R-TSL1 60 210 Y	R-TSL1 70 240 Y	R-TSL1 80 270 Y	R-RSL1 90 300 Y	R-TSL1 100 360 Y
<b>remote oil separator</b>																
TOOWK200	•	•	•	•					•	•	•	•	•	•		
TOOWK201					•	•	•	•							•	•
TOOWK202																
<b>visual indicator for oil strainer clogging</b>																
TOOWK150	•	•	•	•	•	•	•	•	•	•	•	•	•	•	•	•
<b>electric indicator for oil strainer clogging</b>																
TOOWK151	•	•	•	•	•	•	•	•	•	•	•	•	•	•	•	•
<b>water cooled oil cooler</b>																
SZ-WOC1	•	•	•	•	•	•			•	•	•	•	•	•		
SZ-WOC2							•	•							•	•
SZ-WOC3																
<b>air cooled oil cooler</b>																
SZ-AOC1	•	•	•	•	•	•			•	•	•	•	•	•		
SZ-AOC2							•	•							•	•
SZ-AOC3																
<b>economizer kit for R22</b>																
TOOWK300									•	•						
TOOWK302											•	•				
TOOWK304													•	•		
TOOWK306															•	•
<b>economizer kit for R404a-R507a</b>																
TOOWK301									•	•						
TOOWK303											•	•				
TOOWK305													•	•		
TOOWK307															•	•
<b>lubricant for R22 (19 l can)</b>																
SZ-OIL2 (FCH)	•	•	•	•	•	•	•	•	•	•	•	•	•	•	•	•
<b>lubricant for R404a, 507a, R143a (19 l can)</b>																
SZ-OIL3 (FCL)	•	•	•	•	•	•	•	•	•	•	•	•	•	•	•	•

**Diagram Legend** (see opposite page)

**Sub Cooler**

- F1 = Economiser Outlet
- F2 = Liquid Inlet for Sub Cooling
- F3 = Refrigerant Inlet for TEV
- F4 = Liquid Outlet – Subcooled Liquid

**Oil Separator**

- 1 = Refrigerant Outlet
- 2 = Service Valve Connection
- 3 = Refrigerant Inlet
- 4 = Connection for Oil Charge Valve
- 5 = Oil Level Sight Glass
- 6 = Parallel Compressors Oil Outlet
- 7 = Oil Level Control
- 8 = Oil Outlet
- 9 = Oil Heater
- 10 = Safety Valve Connection
- 11 = Thermostat Sensor





## Artisan Technology Group is your source for quality new and certified-used/pre-owned equipment

- FAST SHIPPING AND DELIVERY
- TENS OF THOUSANDS OF IN-STOCK ITEMS
- EQUIPMENT DEMOS
- HUNDREDS OF MANUFACTURERS SUPPORTED
- LEASING/MONTHLY RENTALS
- ITAR CERTIFIED SECURE ASSET SOLUTIONS

### SERVICE CENTER REPAIRS

Experienced engineers and technicians on staff at our full-service, in-house repair center

### *InstraView*<sup>SM</sup> REMOTE INSPECTION

Remotely inspect equipment before purchasing with our interactive website at [www.instraview.com](http://www.instraview.com) ↗

### WE BUY USED EQUIPMENT

Sell your excess, underutilized, and idle used equipment. We also offer credit for buy-backs and trade-ins. [www.artisanng.com/WeBuyEquipment](http://www.artisanng.com/WeBuyEquipment) ↗

### LOOKING FOR MORE INFORMATION?

Visit us on the web at [www.artisanng.com](http://www.artisanng.com) ↗ for more information on price quotations, drivers, technical specifications, manuals, and documentation

**Contact us:** (888) 88-SOURCE | [sales@artisanng.com](mailto:sales@artisanng.com) | [www.artisanng.com](http://www.artisanng.com)