

Bock Compressor HG6

Assembly instructions

HG6/1080-4
HG6/1240-4
HG6/1410-4

HG6/1080-4 S
HG6/1240-4 S
HG6/1410-4 S

HGX6/1080-4
HGX6/1240-4
HGX6/1410-4

HGX6/1080-4 S
HGX6/1240-4 S
HGX6/1410-4 S

About these instructions

Read these instructions before assembly and before using the compressor. This will avoid misunderstandings and prevent damage. Improper assembly and use of the compressor can result in serious or fatal injury.

Observe the safety instructions contained in these instructions.

These instructions must be passed onto the end customer along with the unit in which the compressor is installed.

Manufacturer

GEA Bock GmbH
72636 Frickenhausen

Contact

GEA Bock GmbH
Benzstraße 7
72636 Frickenhausen
Germany

GB

Telephone +49 7022 9454 0
Fax +49 7022 9454 137
bock@gea.com
www.bock.de

Contents





Page

1	Safety	4
1.1	Identification of safety instructions	
1.2	Qualifications required of personnel	
1.3	General safety instructions	
1.4	Intended use	
2	Product description	6
2.1	Short description	
2.2	Name plate	
2.3	Type key	
3	Areas of application	8
3.1	Refrigerants	
3.2	Oil charge	
3.3	Limits of application	
4	Compressor assembly	10
4.1	Setting up	
4.2	Pipe connections	
4.3	Pipes	
4.4	Laying suction and pressure lines	
4.5	Operating the shut-off valves	
4.6	Operating mode of the lockable service connections	
5	Electrical connection	13
5.1	Information for contactor and motor contactor selection	
5.2	Standard motor, design for direct or partial winding start	
5.3	Basic circuit diagram for partial winding start with standard motor	
5.4	Special motor: design for direct or star-delta start	
5.5	Circuit diagram for direct start 230 V Δ / 400 V Y	
5.6	Electronic trigger unit MP 10	
5.7	Connecting the trigger unit MP 10	
5.8	Functional test of the trigger unit MP 10	
5.9	Oil sump heater	
6	Commissioning	23
6.1	Preparations for start-up	
6.2	Pressure strength test	
6.3	Leak test	
6.4	Evacuation	
6.5	Refrigerant charge	
6.6	Start-up	
6.7	Avoiding slugging	
6.8	Connection of oil level regulator	
7	Maintenance	25
7.1	Preparation	
7.2	Work to be carried out	
7.3	Spare parts recommendation	
7.4	Accessories	
7.5	Extract from the lubricants table	
7.6	Decommissioning	
8	Technical data	27
9	Dimensions and connections	28
10	Declaration of conformity and installation	30
11	Service	31

GB

1| Safety

1.1 Identification of safety instructions:

	DANGER!	Indicates a dangerous situation which, if not avoided, will cause immediate fatal or serious injury.
	WARNING!	Indicates a dangerous situation which, if not avoided, may cause fatal or serious injury.
	CAUTION!	Indicates a dangerous situation which, if not avoided, may cause fairly severe or minor injury.
	ATTENTION!	Indicates a situation which, if not avoided, may cause property damage.
	INFO!	Important information or tips on simplifying work.

GB

1.2 Qualifications required of personnel

	WARNING!	<p>Inadequately qualified personnel poses the risk of accidents, the consequence being serious or fatal injury. Work on compressors must therefore only be performed by personnel with the qualifications listed below:</p> <ul style="list-style-type: none">• For example, a refrigeration technician, refrigeration mechatronics engineer. As well as professions with comparable training, which enable personnel to assemble, install, maintain and repair refrigeration and air-conditioning systems. Personnel must be capable of assessing the work to be carried out and recognising any potential dangers.
---	-----------------	--

1.3 General safety instructions

	WARNING!	<ul style="list-style-type: none">• Refrigerating compressors are pressurised machines and therefore require particular caution and care in handling.• Risk of burns! Depending on the operating conditions, surface temperatures of over 60 °C on the pressure side or below 0 °C on the suction side can be reached.• The maximum permissible overpressure must not be exceeded, even for testing purposes.
---	-----------------	---

09971-05.2012-DGbFEI

1| Safety

1.4 Intended use

These assembly instructions describe the standard version of the HG6 manufactured by Bock. The compressor is intended for use in refrigeration systems in compliance with the limits of application. Only the refrigerant specified in these instructions may be used.

Any other use of the compressor is prohibited!



WARNING! The compressor may not be used in potentially explosive environments!

The Bock refrigerating compressor named in the title is intended for installing in a machine (within the EU according to the EU Directives 2006/42/EC Machinery Directive, 97/23/EC Pressure Equipment Directive and 2006/95/EC – Low Voltage Directive).

Commissioning is only permissible if the compressor has been installed in accordance with these assembly instructions and the entire system into which it is integrated has been inspected and approved in accordance with legal regulations.

GB

2| Product description

2.1 Short description

- Semi-hermetic four-cylinder reciprocating compressor with suction-gas cooled drive motor.
- Flange-mounted drive motor on the compressor case.
- Preferred application range: normal refrigerating and air-conditioning.

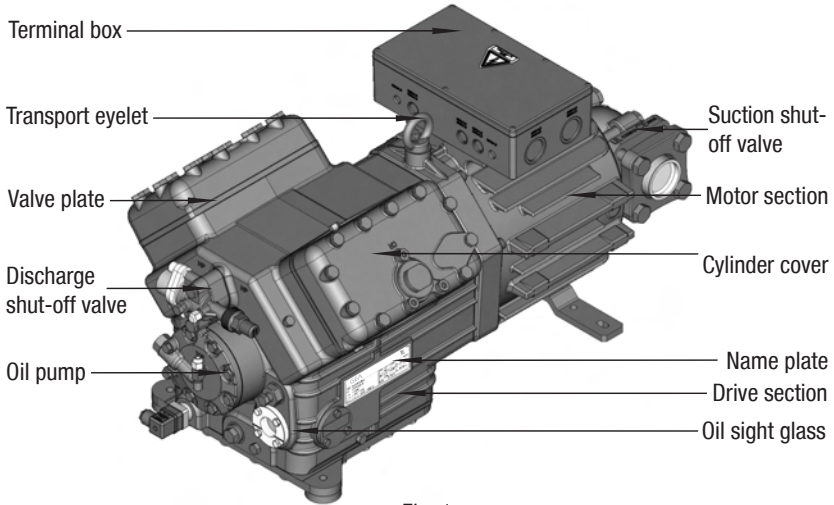

Fig. 1

Dimension and connection values can be found in Chapter 9

2| Product description

2.2 Name plate (example)

 GEA Bock GmbH 72636 Frickenhausen, Germany			
1	Typ : HGX6/1410-4	220-240VΔ/380-420VY -3- 50HZ	6
2	Nr . : AS12345-001	n : 1450 min ⁻¹ V _{th.} :122,4 m ³ /h	7
3	I _{max} : 57,0 A	265-290VΔ/440-480VY -3- 60HZ	8
4	I _{block.} Δ: 172 A Y: 212 A	n : 1740 min ⁻¹ V _{th.} :146,9 m ³ /h	9
5	P _{max} : ND(LP) / HD(HP)=19/28 bar	IP65 Ö: SE 55	10
			11
			12
			13

Fig. 2

1	Type designation	6	Voltage, circuit, frequency	} 50 Hz
2	Machine number	7	Nominal rotation speed	
3	maximum operating current	8	Displacement	} 60 Hz
4	Starting current (rotor blocked)	9	Voltage, circuit, frequency	
	Y: Part winding 1	10	Nominal rotation speed	
	YY: Part windings 1 and 2	11	Displacement	
5	ND (LP): max. admissible operating pressure (g) Low pressure side	12	Oil type filled at the factory	
	HD (HP): max. admissible operating pressure (g) High pressure side	13	Terminal box protection type	

 **Observe the limits of application diagrams!**

 **Electrical accessories can change the IP protection class!**

GB

2.3 Type key (example)

HG X 6 / 1410-4 S

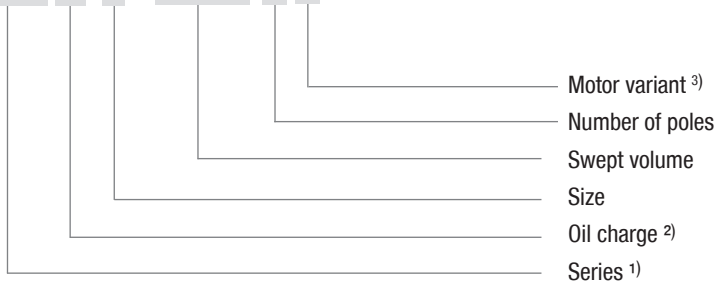

¹⁾ HG - Hermetic Gas-cooled (suction gas-cooled)

²⁾ X - Ester oil charge (HFC refrigerant, e.g. R134a, R404A/R507, R407C)

³⁾ S - More powerful motor, e.g. for air-conditioning applications

3| Areas of application

3.1 Refrigerants

- HFKW / HFC: R134a, R404A/R507, R407C
- (H)FCKW / (H)CFC: R22

3.2 Oil charge

- The compressors are filled at the factory with the following oil type:
 - for R134a, R404A/R507, R407C FUCHS Reniso Triton SE 55
 - for R22 FUCHS Reniso SP 46

Compressors with ester oil charge (FUCHS Reniso Triton SE 55) are marked with an X in the type designation (e.g. HGX6/1410-4).



INFO!

For refilling, we recommend the above oil types.
Alternatives: see lubricants table, Chapter 7.5.

3.3 Limits of application



- ATTENTION!**
- Compressor operation is possible within the operating limits shown in the diagrams. Please note the significance of the shaded areas. Thresholds should not be selected as design or continuous operation points.
 - Max. permissible discharge end temperature 140 °C
 - Max. permissible switching frequency 12x /h.
 - A minimum running time of 3 min. steady-state condition (continuous operation) must be achieved.
 - For operation with supplementary cooling:
 - Use only oils with high thermal stability.
 - Avoid continuous operation near the threshold.
 - For operation with capacity regulator:
 - The suction gas superheat temperature may need to be reduced or set individually when operating near to the threshold.
 - For operation with frequency converter:
 - The maximum current and power consumption must not be exceeded. In the case of operation above the mains frequency, the application limit can therefore be limited.
 - When operating in the vacuum range, there is a danger of air entering on the suction side. This can cause chemical reactions, a pressure rise in the condenser and an elevated compressed-gas temperature. Prevent the ingress of air at all costs!

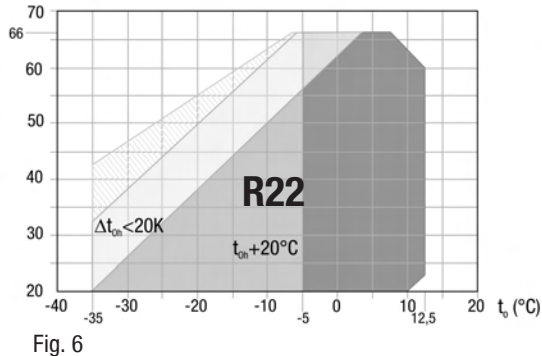
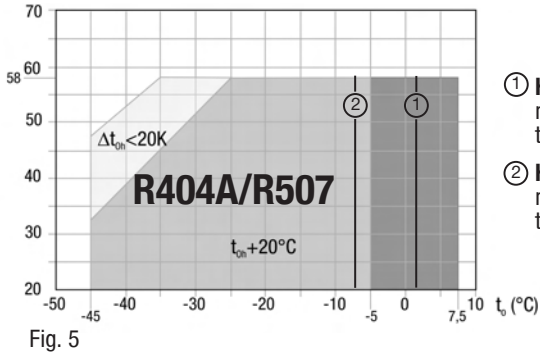
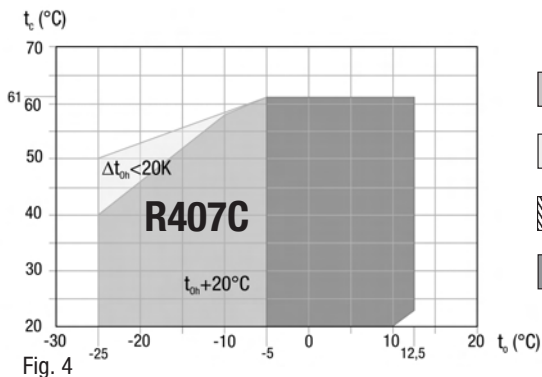
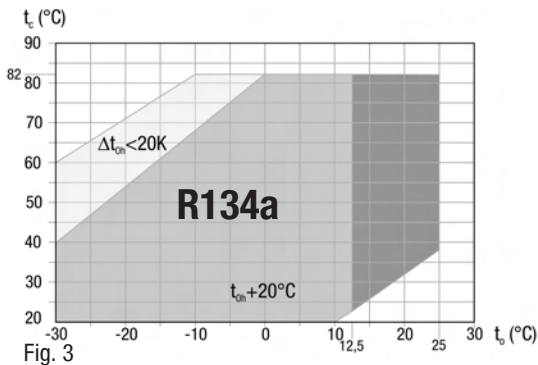

- Unlimited application range
- Supplementary cooling or reduced suction gas temperature
- Supplementary cooling and reduced suction gas temperature
- Motor version S (more powerful motor)

GB

- ① **HGX6/1410-4 S**
max. evaporating temperature
 $t_o = 2\text{ °C}$
- ② **HGX6/1410-4**
max. evaporating temperature
 $t_o = -7\text{ °C}$

t_o Evaporation temperature (°C)
 t_c Condensing temperature (°C)
 Δt_{oh} Suction gas superheat (K)
 t_{oh} Suction gas temperature (°C)

Max. permissible operating pressure (LP/HP)¹⁾: 19/28 bar

¹⁾ LP = Low pressure
HP = High pressure

Design for other areas on request

4| Compressor assembly



INFO!

New compressors are factory-filled with inert gas (3 bar nitrogen). Leave this service charge in the compressor for as long as possible and prevent the ingress of air. Check the compressor for transport damage before starting any work.

4.1 Setting up



- Use transport eyelet.
- Do not lift manually!
- Use lifting gear!

Fig. 7

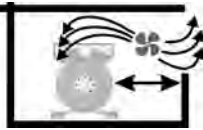

- Provide adequate clearance for maintenance work.
- Ensure adequate compressor ventilation.

Fig. 8



- Do not use in a corrosive, dusty, damp atmosphere or a combustible environment.

Fig. 9

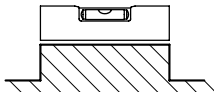

- Setup on an even surface or frame with sufficient load-bearing capacity.
- Single compressor preferably on vibration damper.
- Duplex and parallel circuits always rigid.

Fig. 10

4.2 Pipe connections



ATTENTION! Superheating can damage the valve. Remove the pipe supports from the valve for soldering. Only solder using inert gas to inhibit oxidation products (scale).

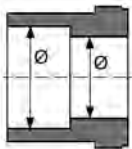

Fig. 11: graduated internal diameter

- The **pipe connections** have graduated inside diameters so that pipes with standard millimetre and inch dimensions can be used.
- The connection diameters of the shut-off valves are rated for maximum compressor output. **The actual required pipe cross section must be matched to the output. The same applies for non-return valves.**

4| Compressor assembly

4.3 Pipes

- Pipes and system components must be clean and dry inside and free of scale, swarf and layers of rust and phosphate. Only use air-tight parts.
- Lay pipes correctly. Suitable vibration compensators must be provided to prevent pipes being cracked and broken by severe vibrations.
- Ensure a proper oil return.
- Keep pressure losses to an absolute minimum.

4.4 Laying suction and pressure lines



INFO! Proper layout of the suction and pressure lines directly after the compressor is integral to the smooth running and vibration behaviour of the system.



ATTENTION! Improperly installed pipes can cause cracks and tears which can result in a loss of refrigerant,

A rule of thumb:

Always lay the first pipe section starting from the shut-off valve **downwards and parallel to the drive shaft.**

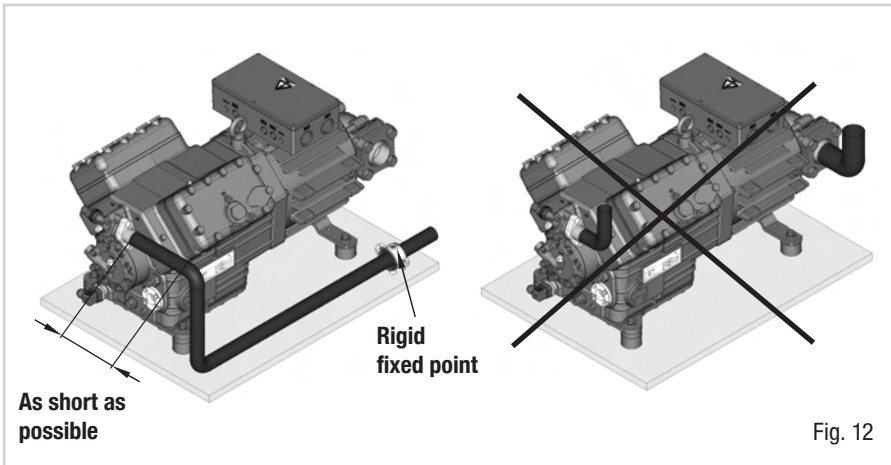

GB

4| Compressor assembly

4.5 Operating the shut-off valves

- Before opening or closing the shut-off valve, release the valve spindle seal by approx. $\frac{1}{4}$ of a turn counter-clockwise.
- After activating the shut-off valve, re-tighten the adjustable valve spindle seal clockwise.

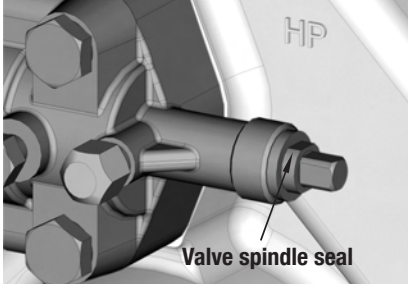

Fig. 13

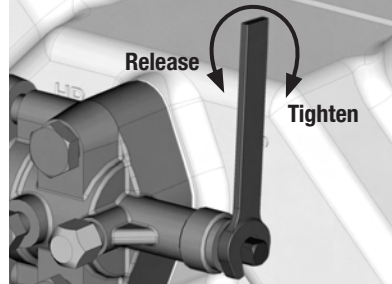

Fig. 14

4.6 Operating mode of the lockable service connections

GB

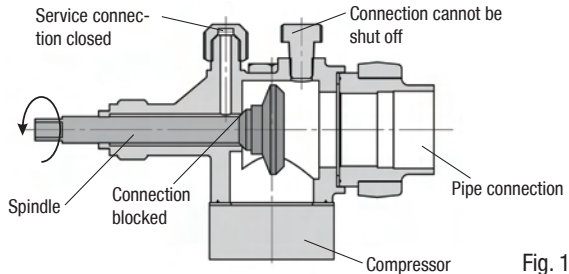

Fig. 15

Opening the shut-off valve:

Spindle: turn to the left (counter-clockwise) as far as it will go.

—> Shut-off valve completely opened / service connection closed.

The connection which cannot be shut off is intended for safety devices.

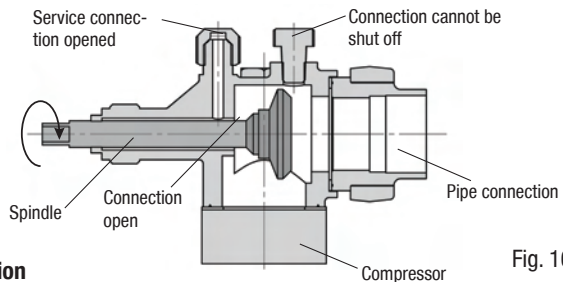

Fig. 16

Opening the service connection

Spindle: Turn $\frac{1}{2}$ - 1 turn clockwise.

—> Service connection opened / shut-off valve opened.

The connection which cannot be shut off is intended for safety devices.

5| Electrical connection

5 Electrical connection



DANGER! High voltage! Risk of electric shock! Only carry out work when the electrical system is disconnected from the power supply!



INFO!

- Connect the compressor motor in accordance with the circuit diagram (see inside of terminal box).
- Use suitable cable entry point of the correct protection type (see name plate) for routing cables into the terminal box. Insert the strain reliefs and prevent chafe marks on the cables.
- Compare the voltage and frequency values with the data for the mains power supply.

Only connect the motor if these values are the same.

5.1 Information for contactor and motor contactor selection

All protection equipment, switching and monitoring devices must comply with the local safety regulations and established specifications (e.g. VDE) and regulations as well as the manufacturer's specifications. **Motor protection switch is required!** Motor contactors, feed lines, fuses and motor protection switches must be rated according to the maximum operating current (see name plate). Set the short circuit trigger current at max. 7 times the permissible operating current according to the compressor name plate.

GB

5.2 Standard motor, design for direct or partial winding start

Designation on the name plate	Sticker on the terminal box
Y/YY	

Compressors with this marking are suitable for direct or partial winding start. The motor winding is subdivided into two parts: Partial winding 1 = 66% and part winding 2 = 33%. This winding division reduces the start-up current needed for a part winding start to approx. 65% of that for a direct start.



INFO! A mechanical unloaded start with bypass solenoid valve is not required.

5.3 Basic circuit diagram for part winding start with standard motor

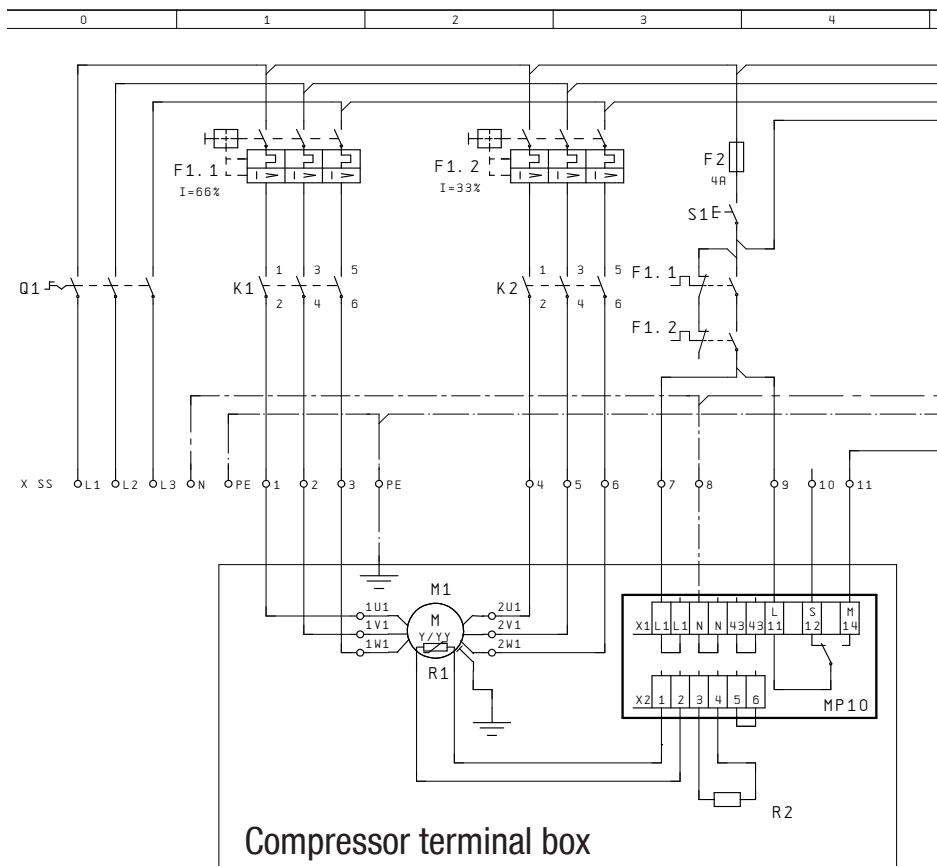
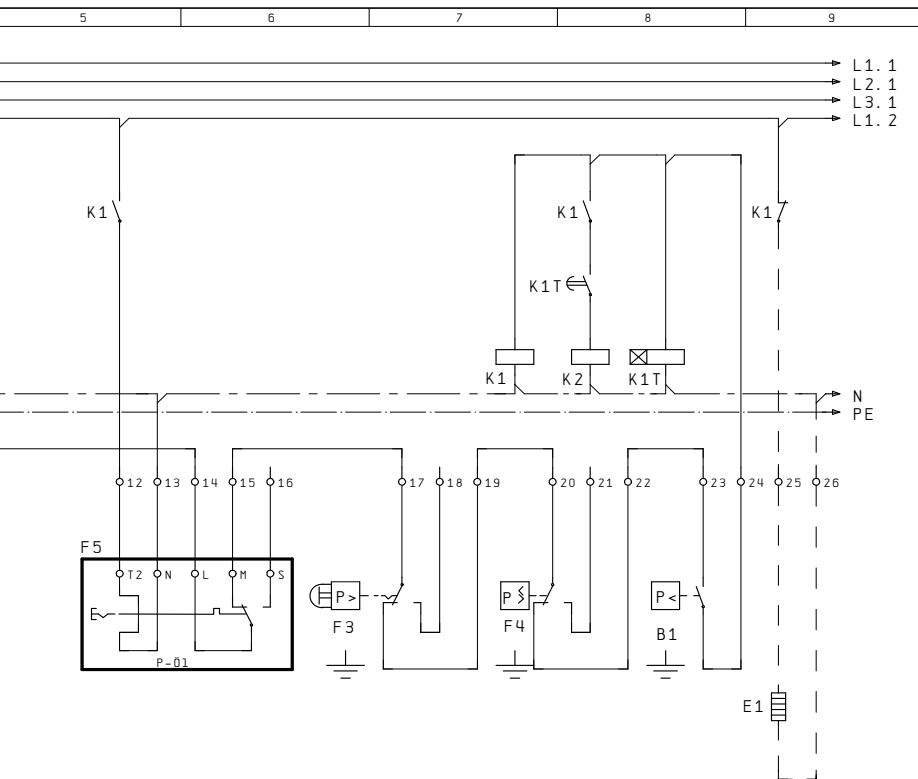

Fig. 17

R1	Cold conductor (PTC sensor) motor winding
R2	Thermal protection thermostat (PTC sensor)
F1.1 / 1.2	2 motor protection switches (66% / 33% of I_A total)
F2	Control power circuit fuse
F3	High pressure safety monitor
F4	Safety chain (high/low pressure monitoring)
F5	Oil differential pressure monitor
B1	Release switch (thermostat)



GB

Q1	Main switch
M1	Compressor motor
K1	Mains contactor (part winding 1)
K2	Mains contactor (part winding 2)
K1T	Delay relay max. 1s
S1	Control voltage switch
E1	Oil sump heater

5| Electrical connection

The motor is wired for direct start (YY) at the factory. For part winding start Y / YY, the bridges must be removed and the motor feed line connected according to the circuit diagram:

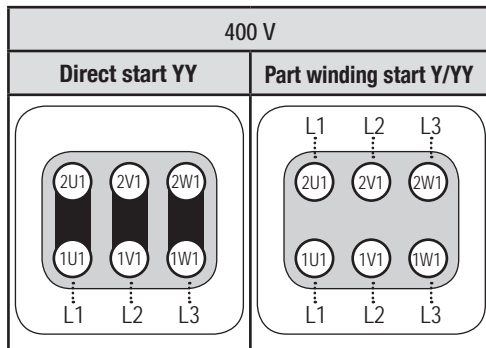

ATTENTION! Failure to do this results in opposed rotary fields and results in damage to the motor. After the motor starts up via partial winding 1, partial winding 2 must be switched on after a maximum delay of one second. Failure to comply can adversely affect the service life of the motor.

GB

5| Electrical connection

5.4 Special motor: design for direct or star-delta start

A mechanical unloaded start with bypass solenoid valve (accessories) is required for the star-delta start.

Designation on the name plate	Sticker on the terminal box
Δ / Y	

Star-delta start-up is only possible for 230 V power supply. Example:

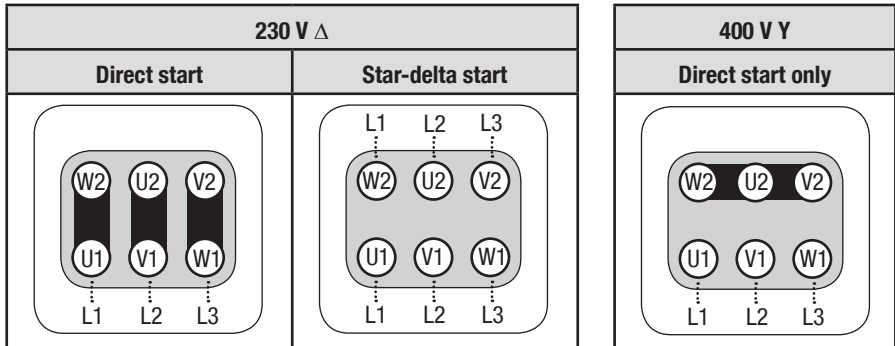

GB

5.5 Circuit diagram for direct start 230 V Δ / 400 V Y

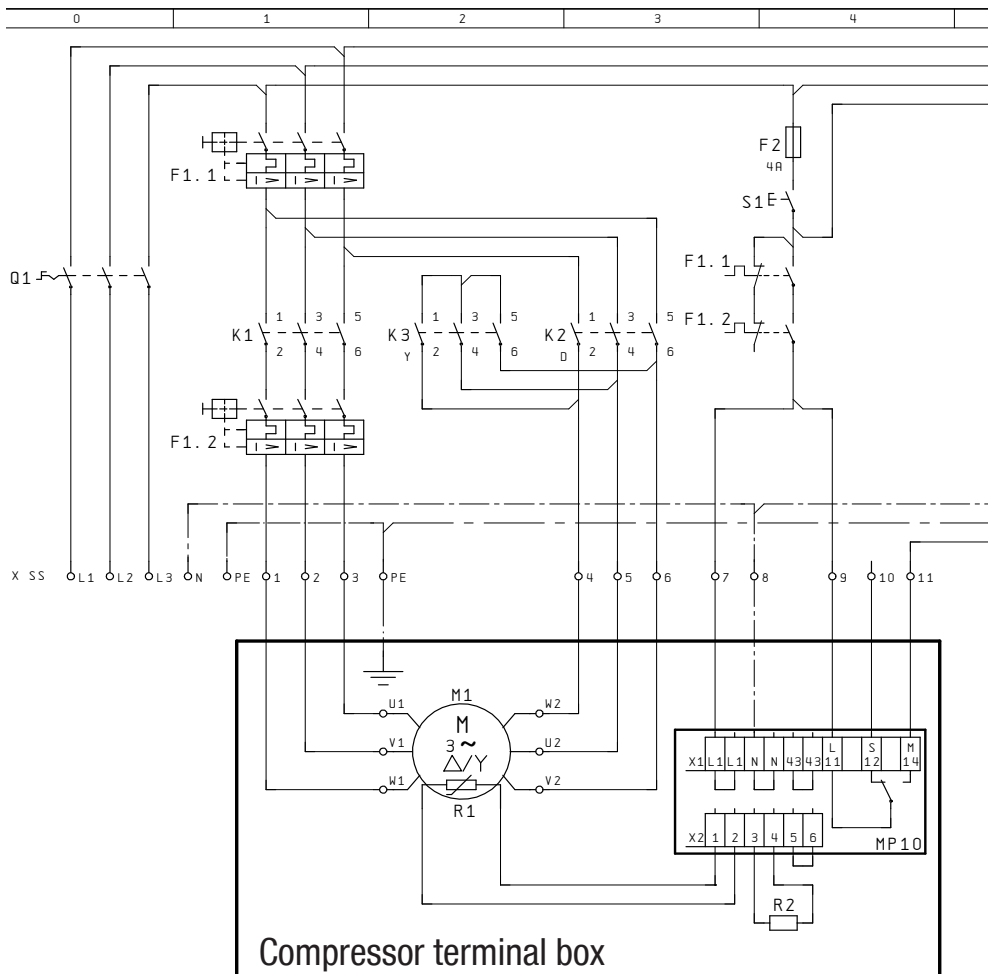
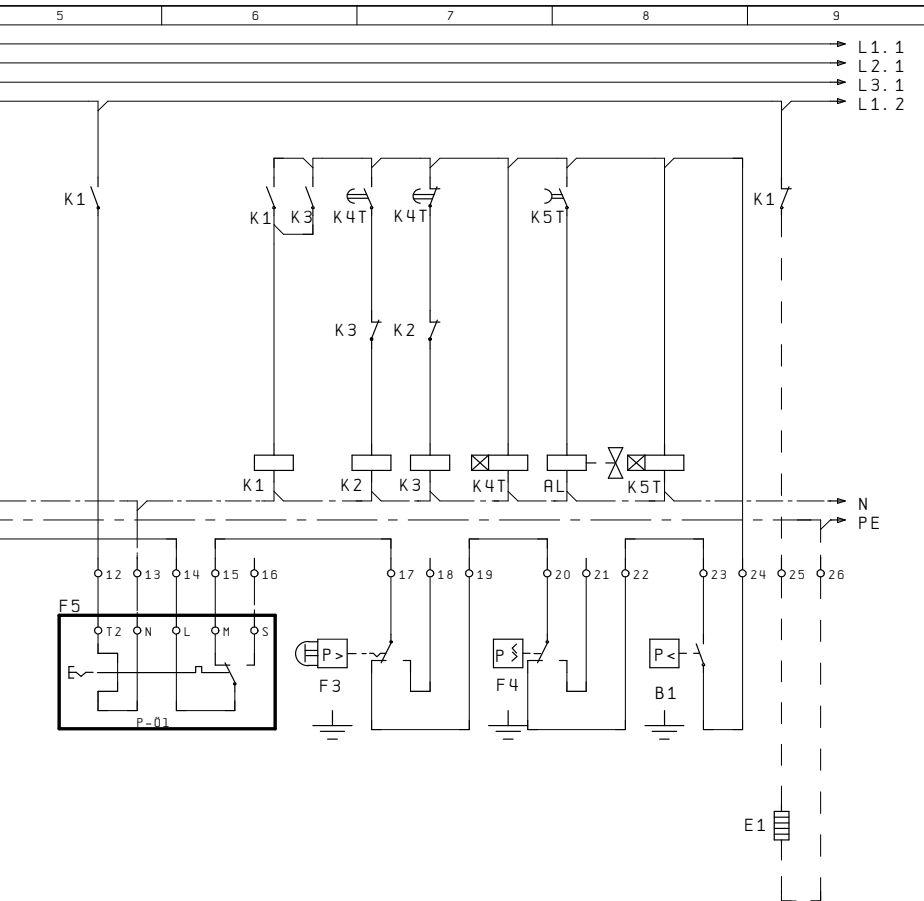

Fig. 18

R1	Cold conductor (PTC sensor) motor winding
R2	Thermal protection thermostat (PTC sensor)
F1.1 / 1.2	2 motor protection switches
F2	Control power circuit fuse
F3	High pressure safety monitor
F4	Safety chain (high/low pressure monitoring)
F5	Oil differential pressure monitor
B1	Enabling switch (thermostat)
Q1	Main switch



GB

M1	Compressor motor
K1	Mains contactor
K2	Δ-contactor
K3	Y-contactor
K4T	Delay relay S/D changeover
K5T	Delay relay, start unloader
S1	Control voltage switch
AL	Start unloader
E1	Oil sump heater

5| Electrical connection

5.6 Electronic trigger unit MP 10

The compressor motor is fitted with cold conductor temperature sensors (PTC) connected to the electronic trigger unit MP 10 in the terminal box. Readiness to operate is signalled by the H3 LED (green) after the power supply is applied. In the case of excess temperature in the motor winding, the unit switches off the compressor and the H1 LED lights red.

The hot gas side of the compressor can also be protected against overtemperature using a thermal protection thermostat (accessory). The H2 LED (red) is provided for the protection function.

The unit trips when an overload or inadmissible operating conditions occur. Find and remedy the cause.



INFO! The unit has a restart prevention device. After you have rectified the fault, either interrupt the mains voltage. This unlocks the restart prevention device and the LEDs H1 and H2 go out.

5.7 Connection of the trigger unit MP10



INFO! Connect the trigger unit MP10 in accordance with the circuit diagram. Protect the trigger unit with a delayed-action fuse (F) of max. 4 A. In order to guarantee the protection function, install the trigger unit as the first element in the control power circuit.

Temperature monitoring connections:

- Motor winding: Terminals 1 - 2
- Thermal protection thermostat: Terminals 3 - 4
- Restart prevention: Terminals 5 - 6



ATTENTION! Terminals 1 - 6 on the trigger unit MP 10 and terminals PTC 1 and PTC 2 on the compressor terminal board must not come into contact with mains voltage. This would destroy the trigger unit and PTC sensors. The supply voltage at L1-N (+/- for DC 24 V version) must be identical to the voltage at terminals 11, 12, 14 and 43.

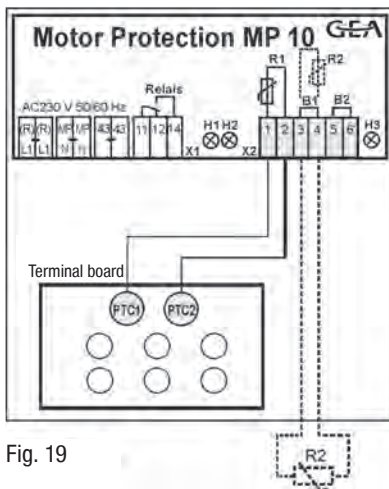

Fig. 19

5| Electrical connection

5.8 Function test of the trigger unit MP 10

Before start-up, troubleshooting or making changes to the control power circuit, check the functionality of the trigger unit:

Pos	Procedure	LED H1 red	LED H2 red	LED H3 green
1	<ul style="list-style-type: none">• Interrupt power supply (L1 or S1)• Release the motor temperature sensor connection (1 or 2)• Release the hot gas temperature sensor (if installed) (3 or 4)	OFF	OFF	OFF
2	<ul style="list-style-type: none">• Restore the power supply (L1 or S1)• Function check of motor temperature sensor: operational• Function check of hot gas temperature sensor: operational	ON	ON	ON
3	<ul style="list-style-type: none">• Interrupt power supply again (L1 or S1)• Reconnect terminals 1 or 2 and/or 3 or 4	OFF	OFF	OFF
4	<ul style="list-style-type: none">• Restore the power supply (L1 or S1):• MP 10 is operational again	OFF	OFF	ON

The compressor and the trigger unit MP10 are operational when the H3 LED (green) lights.

GB

5| Electrical connection

5.9 Oil sump heater

During compressor standstill and depending on the pressure and ambient temperature, refrigerant diffuses into the compressor's lubricating oil. This reduces the oil's lubricating ability. When the compressor is started, the refrigerant contained in the oil evaporates due to the decline in pressure. This can result in oil foaming and oil exodus which can result in oil hammer in certain circumstances.

In order to prevent damage to the compressor, the compressor is equipped with an oil sump heater as standard. The oil sump heater must always be connected and operated.

Operation mode: The oil sump heater operates when the compressor is shut down. The oil sump heater is switched off when the compressor starts.

Connection: Connect the oil sump heater via an auxiliary contact (or parallel-wired auxiliary contactor) of the compressor contactor to a separate current path.
Electrical data: 230 V - 1 - 50/60 Hz, 140 W.

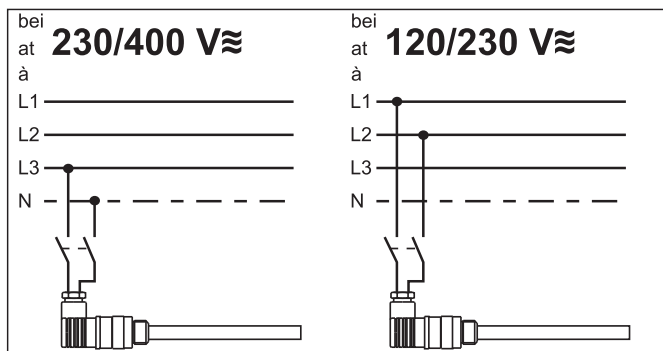

Fig. 20



ATTENTION! Connection to the current path of the safety control chain is not permitted

GB

6| Commissioning

6.1 Preparations for start-up



INFO!

In order to protect the compressor against inadmissible operating conditions, high-pressure and low-pressure pressostats controls are mandatory on the installation side.

The compressor has undergone trials in the factory and all functions have been tested. There are therefore no special running-in instructions.

Check the compressor for transport damage!

6.2 Pressure strength test



WARNING! The compressor must never be pressurised using oxygen or other technical gases!
The maximum permissible overpressure of the compressor must not be exceeded at any time during the testing process (see name plate data)!

The compressor has been factory-tested for pressure resistance. The following must be observed if the entire plant is subjected to an additional pressure strength test:

- Test the refrigeration circuit according to EN 378-2 or a corresponding safety standard.
- The pressure strength test is best carried out using dry nitrogen (N₂).
- Do not mix any refrigerant with the testing medium (N₂) as this could cause the ignition limit to shift into the critical range.

GB

6.3 Leak test

- Carry out the leak test of the refrigerating system in accordance with EN 378-2 or a corresponding safety standard **without including the compressor.**
- Do not mix any refrigerant with the testing medium, as this could cause the ignition limit to shift into the critical range.

6.4 Evacuation



ATTENTION! Do not start the compressor if it is under vacuum. Do not apply any voltage - even for test purposes (must only be operated with refrigerant).

Under vacuum, the spark-over and creepage current distances of the terminal board connection bolts shorten; this can result in winding and terminal board damage.

- First evacuate the **system** and then include **the compressor in the evacuation process.**
- Relieve the compressor pressure.
- Open the suction and pressure line shut-off valves.
- Evacuate the suction and discharge pressure sides using the vacuum pump.
- At the end of the evacuation process, the vacuum should be < 1.5 mbar when the pump is switched off.
- Repeat this process as often as is required.

6| Commissioning

6.5 Refrigerant filling



CAUTION! Wear personal protective clothing such as goggles and protective gloves!

- Make sure that the suction and pressure line shut-off valves are open.
- With the compressor switched off, add the liquid refrigerant directly to the condenser or receiver, breaking the vacuum.
- If the refrigerant needs topping up after starting the compressor, it can be topped up in vapour form on the suction side, or, taking suitable precautions, also in liquid form at the inlet to the evaporator.



INFO!

- **Avoid overfilling the system with refrigerant!**
- **In order to prevent shifts in concentration, zeotropic refrigerant blends (e.g. R407C) must always only be added to the refrigerating system in liquid form.**
- **Do not pour liquid refrigerant through the suction line shut-off valve on the compressor.**
- **It is not permissible to mix additives with the oil and refrigerant.**

6.6 Commissioning



WARNING! Ensure that both shut-off valves are open before starting the compressor!

- Check that the safety and protection devices (pressure switch, motor protection, electrical contact protection measures, etc.) are functioning properly.
- Switch on the compressor and let it run for at least 10 minutes.
- Check the **oil level** : The oil must be visible in the sight glass.



ATTENTION! If larger quantities of oil have to be topped up, there is a risk of oil impact effects. If this is the case, check the oil return!

6.7 Avoid slugging



ATTENTION! Slugging can result in damage to the compressor and cause refrigerant to leak.

To prevent slugging:

- The complete refrigeration plant must be properly designed.
- All components must be compatibly rated with each other with regard to output (particularly the evaporator and expansion valves).
- Suction gas superheating at the compressor input **should be min. 7 - 10 K** (check the setting of the expansion valve).
- The system must reach a state of equilibrium.
- Particularly in critical systems (e.g. several evaporator points), measures such as the use of liquid traps, solenoid valve in the liquid line, etc. are recommended.

There should be no movement of coolant whatsoever while the compressor is at a standstill.

6 | Commissioning

6.8 Connection of oil level regulator

Oil level regulation systems have proven themselves with parallel circuits of several compressors. The connection "O" is provided for installing an oil level regulator (see dimensions drawing). All common oil level regulators from AC&R, ESK and Carly as well as the OM3 TraxOil oil level regulation system from Alco can be connected directly without adapters (see Fig. 19). A sight glass on the oil level regulator is not required.

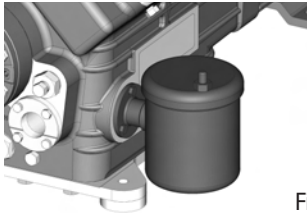

Mechanical oil level regulator at the "O" connection

Fig. 21

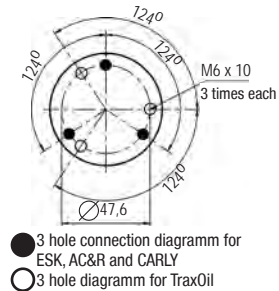

7 | Maintenance

7.1 Preparation



- WARNING!** Before starting any work on the compressor:
- Switch off the compressor and secure it to prevent a restart.
 - Relieve compressor of system pressure.
 - Prevent air from infiltrating the system!
- After maintenance has been performed:
- Connect safety switch.
 - Evacuate compressor.
 - Release switch-on lock.

7.2 Work to be carried out

In order to guarantee optimum operational reliability and service life of the compressor, **we recommend** carrying out servicing and inspection work at regular intervals:

- **Oil change:**
 - not mandatory for factory-produced series systems.
 - for field installations or when operating near the application limit: for the first time after 100 to 200 operating hours, then approx. every 3 years or 10,000 - 12,000 operating hours. Dispose of used oil according to the regulations; observe national regulations.
- **Annual checks:** Oil level, leak tightness, running noises, pressures, temperatures, function of auxiliary devices such as oil sump heater, pressure switch.

7 | Maintenance

7.3 Recommended spare parts

HG6 / ...	1080-4 (S)	1240-4 (S)	1410-4 (S)
Designation	Ref. No.	Ref. No.	Ref. No.
Set of gaskets		80041	
Valve plate kit		08498	
Oil pump kit		80116	
Oil sump heater kit 230 V ~		08426	

Only use genuine Bock spare parts!

7.4 Accessories

Available accessories can be found on the Internet at www.bock.de.

7.5 Extract from the lubricants table

The oil type filled as standard in the factory is marked on the **name plate**. **This oil type should be used as a preference.** Alternatives are stated in the extract from our lubricants table below.

Refrigerants	Bock standard oil types	Recommended alternatives
HFC (e.g. R134a, R407C)	Fuchs Reniso Triton SE 55	Fuchs SEZ 32 ICI Emkarate RL 46 S Mobil Arctic AL 46 Shell Clavus R 46
HCFC (e.g. R22)	Fuchs Reniso SP 46	Mobil SHC 425 Shell Clavus SD 22-12 Sunoil Suniso 4GS Texaco Capella WF 46

7.6 Decommissioning

Close the shut-off valves on the compressor. Drain the refrigerant (it must not be discharged into the environment) and dispose of it according to the regulations. When the compressor is depressurised, undo the fastening screws of the shut-off valves. Remove the compressor using an appropriate hoist. Dispose of the oil inside in accordance with the applicable national regulations.

8 | Technical data

Type	No. of cylinders	Displacement 50 / 60 Hz (1450 / 1740 rpm)	Electrical data ③				Weight	Connections ④		Oil charge	Sound pressure level
			Voltage ①	Max. Operating current ② PW 1 + 2	Max. power consumption ② PW 1 / PW 1 + 2	Starting current (rotor locked) PW 1 / PW 1 + 2		Discharge line DV	Suction line SV		
		m ³ /h	A	kW	A	kg	mm (inch)	mm (inch)	Ltr.	dB(A)	
HG6/1080-4		93,7 / 112,4	47	26,3	149 / 189	218				73 / 71 / 70	
HG6/1080-4 S		93,7 / 112,4	57	31,0	172 / 212	223					
HG6/1240-4	4	107,6 / 129,1	57	30,5	172 / 212	222	35 (1 3/8)	54 (2 1/8)	3,6	74 / 72 / 71	
HG6/1240-4 S		107,6 / 129,1	71	36,0	204 / 250	224					
HG6/1410-4		122,4 / 146,9	57	35,6	172 / 212	219				75 / 72 / 71	
HG6/1410-4 S		122,4 / 146,9	71	42,6	204 / 250	222					

380-420 V Y/YY - 3 - 50 Hz PW
440-480 V Y/YY - 3 - 60 Hz PW
PW = Part Winding
Winding ratio : 66% / 33%

① Tolerance (\pm 10%) relative to the mean value of the voltage range.

② Other voltages and types of current on request.

③ - The specifications for max. power consumption apply for 50Hz operation.
For 60Hz operation, the specifications have to be multiplied by the factor 1.2. The max. working current remains unchanged.

- Take account of the max. operating current / max. power consumption for design of fuses, supply lines and safety devices. Fuse: Consumption category AC3

③ All specifications are based on the average of the voltage range

④ For solder connections

⑤ L = low temperature (-35 / 40 °C), M = normal cooling (-10 / 45 °C),
H = air conditioning (5 / 50°C) sound pressure level measured in low reflection measuring area, measuring distance 1m.

Compressor operation at 50 Hz (1450 rpm), refrigerant R404A.
Values stated are average values, tolerance \pm 2 dB(A).

9| Dimensions and connections

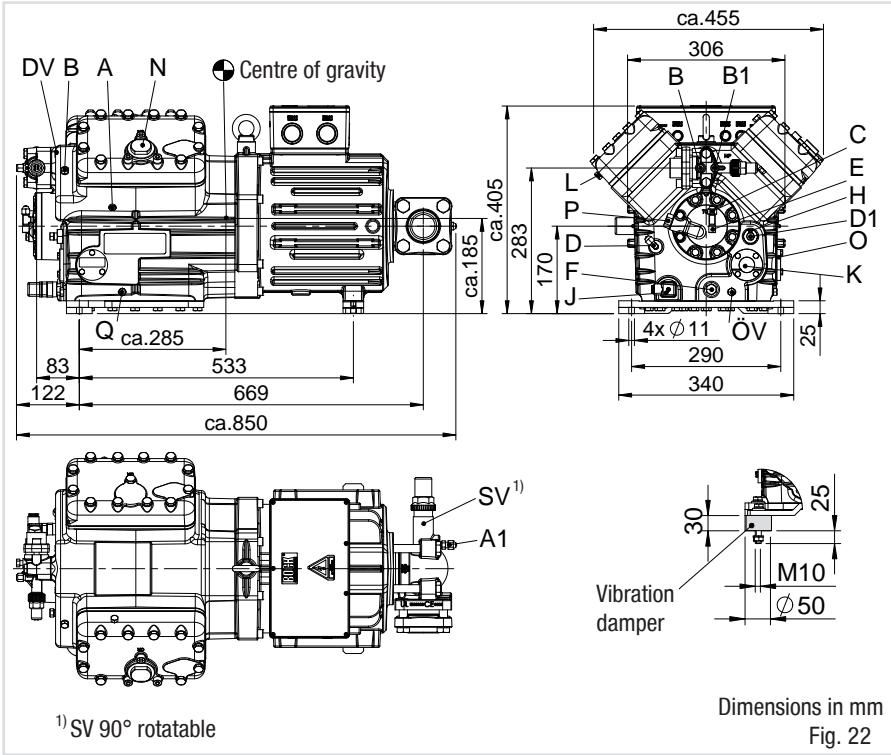

¹⁾ SV 90° rotatable

GB

9| Dimensions and connections

SV	Suction line	see technical data, Chapter 8	
DV	Discharge line		
A	Connection suction side, not lockable		1/8" NPTF
A1	Connection suction side, lockable		7/16" UNF
B	Connection discharge side, not lockable		1/8" NPTF
B1	Connection discharge side, lockable		7/16" UNF
C	Connectoin oil pressure switch OIL		7/16" UNF
D	Connection oil pressure switch LP		7/16" UNF
D1	Connection oil return from oil separator		1/4" NPTF
E	Connection oil pressure gauge		7/16" UNF
F	Oil drain		M22 x 1,5
H	Oil charge plug		M22 x 1,5
J	Oil sump heater		M22 x 1,5
K	Sight glass		-
L	Connection thermal protection thermostat		1/8" NPTF
N	Connection capacity controller		M45 x 1,5
O	Connection oil level regulator		3 x M6
ÖV	Connection oil service valve		1/4" NPTF
P	Connection oil differential pressure sensor		M20 x 1,5
Q	Connection oil temperature sensor		1/8" NPTF

GB

10| Declaration of conformity and installation

DECLARATION OF CONFORMITY CE 96

for using the compressors within the European Union
(in accordance with Low Voltage Directive 2006/95/EC)

We hereby declare that the following refrigerating compressors

Product designation: **HG6**
comply with the Low Voltage Directive 2006/95/EC.

Applied harmonised standard:
EN 60034-1, EN 60204-1

DECLARATION OF INSTALLATION

for using the compressors within the European Union
(in accordance with Machinery Directive 2006/42/EC)

The manufacturer: GEA Bock GmbH, Benzstraße 7
72636 Frickenhausen, Tel.: 07022/9454-0

hereby declares that the refrigerating compressor **HG6** complies with the basic requirements of
Appendix II 1B of the Machinery Directive 2006/42/EC.

The following harmonised standards have been applied:

EN ISO 12100-1
EN ISO 12100-2
EN 12693
EN 349

A partly completed machine may only be put into operation when it has been established
that the machine, into which the partly completed machine is to be installed, conforms to the
regulations of the Machinery Directive (2006/42/EC).

The manufacturer undertakes to transmit electronically the special documentation required by
individual states for partly completed machinery on request.

The special technical documentation required for partly completed machinery has been created
in accordance with Appendix VII Part B.

Person responsible for documentation is: Wolfgang Sandkötter, Benzstraße 7, 72636 Frickenhausen.



ppa. Wolfgang Sandkötter,
Chief Development Officer

Frickenhausen, 01.11.2011

GB

11| Service

Dear customer,

Bock compressors are top-quality, reliable and service-friendly quality products.

If you have any questions about installation, operation and accessories, please contact our technical service or specialist wholesaler and/or our representative. The Bock service team can be contacted

by phone: **+49 7022 9454-0**
via e-mail: **bock@gea.com**
or on the Internet at: **www.bock.de**

In addition, for German-speaking countries we have set up a toll-free Bock hotline 00 800 / 800 000 88 from Monday to Saturday between 8 am and 9 pm.

Any suggestions you may have regarding the on-going development of our compressor, equipment and parts programme are welcome at any time.

Yours faithfully

GEA Bock GmbH

Benzstraße 7

72636 Frickenhausen

Germany

GB

We also provide information on the Internet at **www.bock.de**.

For example, under the "Documentation" link you will find:

- Technical information
- Product information
- Product brochures
- and much more

09971-05.2012-DGbFEI

QUALITY SYSTEM



certified by DQS according to
DIN EN ISO 9001 Reg. No. 2177





Excellence

Passion

Integrity

Responsibility

GEA-versity

GEA Group is a global engineering company with multi-billion euro sales and operations in more than 50 countries. Founded in 1881, the company is one of the largest providers of innovative equipment and process technology. GEA Group is listed in the STOXX Europe 600 Index.



GEA Refrigeration Technologies

GEA Bock GmbH

Benzstraße 7, 72636 Frickenhausen, Germany
Telephone: +49 7022 9454-0, Fax: +49 7022 9454-137
bock@gea.com, www.bock.de