



## fan data

14.11.2024

version FANselect V 1.01 (241114), AMCA V 1.03 September, 2021&lt;br&gt;RLT V 1.00 Dezember, 2021 / 1.24.11.14 | 30813 | (user ZAFS20813)



type	<b>FN080-SDS.6N.V7</b>
article no.	140583   Portfolio STD-WW

## technical data

motor		AC
mains supply	-	3~ 400V 50Hz D
nominal current ( $I_N$ )	A	3.60
ambient temperature, max. limit ( $t_r$ )	°C	70
efficiency grade $\eta_{statA}$	%	36,0
efficiency grade $N_{actual}$   $N_{target}$		<b>40,9</b>   40
ErP-conformity		2015
grille   influence		pressure side   measured

## fan data

frequency ( $f_{DP}$ )   ( $f_{max}$ )	Hz	<b>50</b>   60
dimensions (w x h x d)	mm	866 x 866 x 278
product weight ( $m_{pr}$ )	kg	36.5

PF:PF\_50; Type:FN080-SDS; STol:±10 %

# FANselect



## performance curve / acoustics

14.11.2024

Version FANselect V 1.01 (241114), AMCA V 1.03 September, 2021 <br> RLT V 1.00 Dezember, 2021 / 1.24.11.14 | 30813 | (user ZAFS20813)

### 1 FN080-SDS.6N.V7

Measured in full nozzle with pressure side guard grille in air flow direction V in installation type A according to ISO5801

140583 | Portfolio STD-WW measurement density 1.17 [kg/m³]

### air performance $p_{sF}$

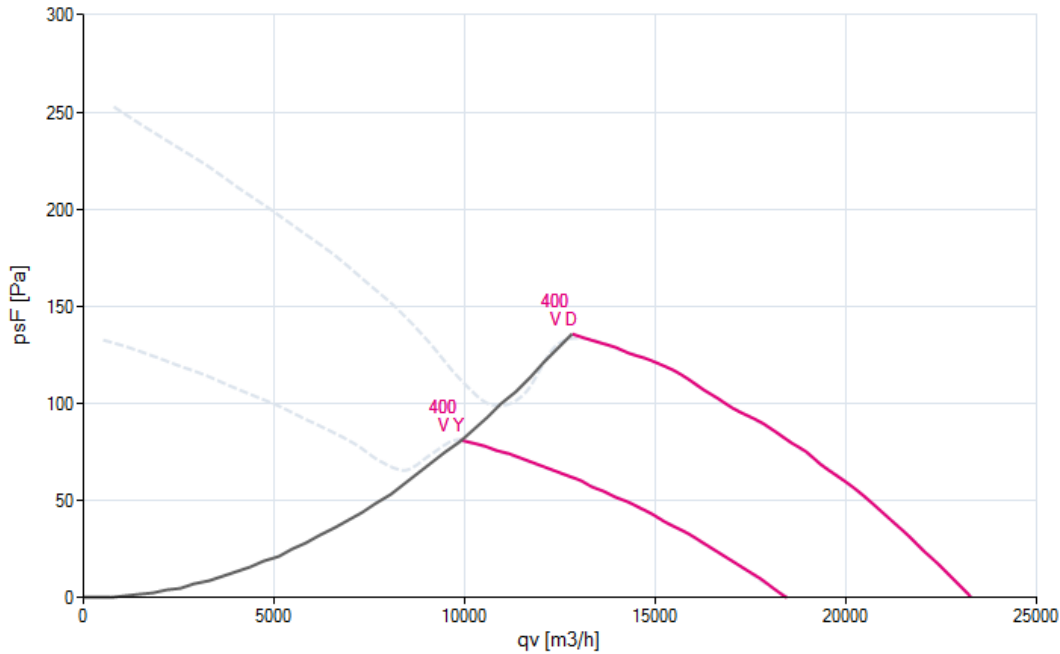

### acoustics ( $L_{w(A),5}$ )

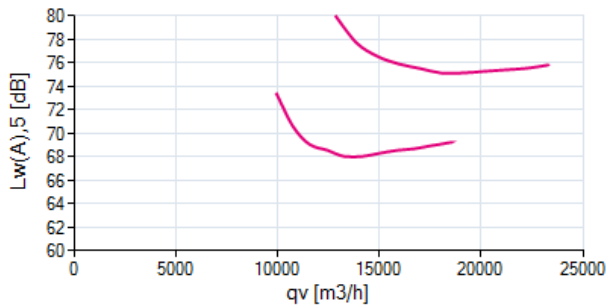

### acoustics ( $L_{w(A),6}$ )

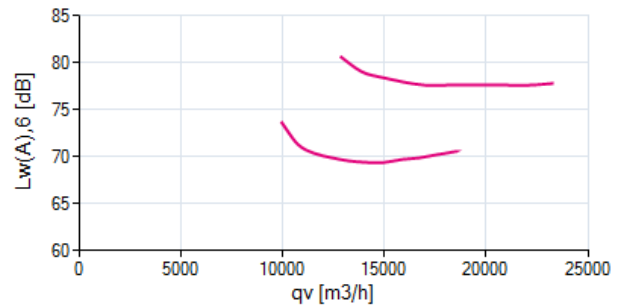

### 1 FN080-SDS.6N.V7

f [Hz]	sum	63	125	250	500	1000	2000	4000	8000
$L_{w(A),5}$	-	-	-	-	-	-	-	-	-
$L_{w,5}$	-	-	-	-	-	-	-	-	-

f [Hz]	sum	63	125	250	500	1000	2000	4000	8000
$L_{w(A),6}$	-	-	-	-	-	-	-	-	-
$L_{w,6}$	-	-	-	-	-	-	-	-	-

# FANselect



## efficiency grade / power input

14.11.2024

Version FANselect V 1.01 (241114), AMCA V 1.03 September, 2021 <br> RLT V 1.00 Dezember, 2021 / 1.24.11.14 | 30813 | (user ZAFS20813)

1

**FN080-SDS.6N.V7**

Measured in full nozzle with pressure side guard grille in air flow direction V in installation type A according to ISO5801

140583 | Portfolio STD-WW

measurement density 1.17 [kg/m³]

efficiency grade  $\eta_F$

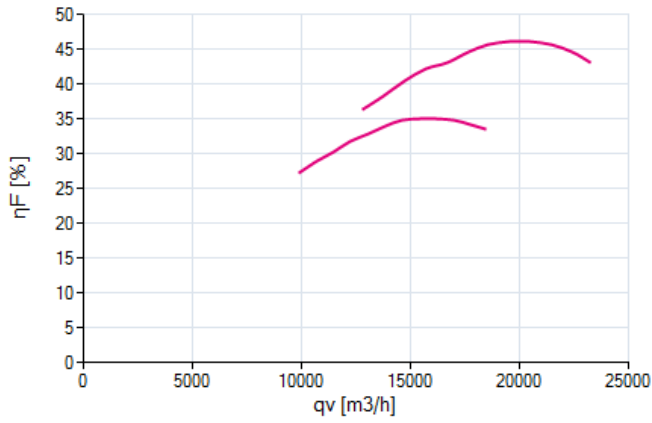

efficiency grade  $\eta_{sF}$

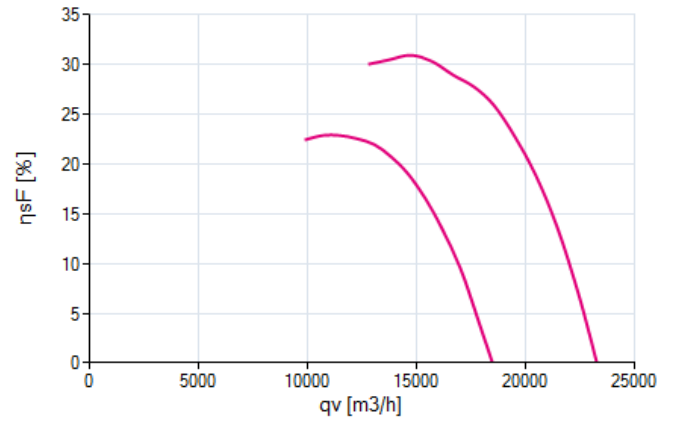

power input  $P_1$

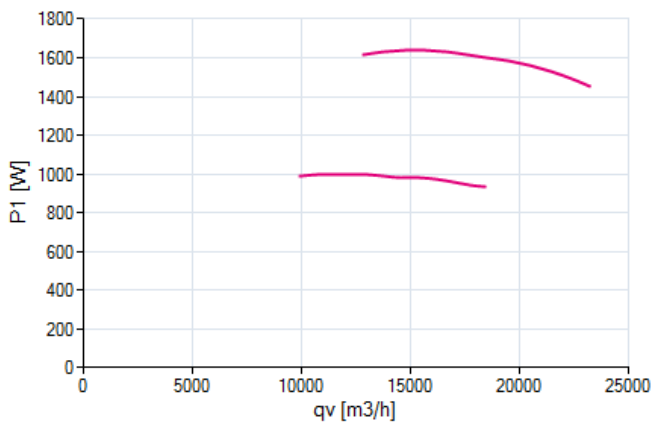



# FANselect

## nominal values

14.11.2024

version FANselect V 1.01 (241114), AMCA V 1.03 September, 2021<br>RLT V 1.00 Dezember, 2021 / 1.24.11.14 | 30813 | (user ZAFS20813)

1



**FN080-SDS.6N.V7**  
140583

3~ 400V +10/-10 D/Y 50Hz P1 1.60/1.0kW P2 1.25/0.58kW  
3.60/1.80A DI=0% 870/670/MIN COSY 0.66 70°C  
3~ 400V +10/-10 D/Y 60Hz P1 2.30/1.15kW P2 1.55/0.50kW  
4.10/2.00A DI=0% 930/640/MIN COSY 0.78 60°C  
3~ 460V +10/-10 D/Y 60Hz P1 2.50/1.4kW P2 1.85/0.69kW  
4.20/2.20A DI=0% 990/710/MIN COSY 0.75 55°C  
IP54 THCL155

## drawing

14.11.2024

version FANselect V 1.01 (241114), AMCA V 1.03 September, 2021<br>RLT V 1.00 Dezember, 2021 / 1.24.11.14 | 30813 | (user ZAFS20813)

1



**FN080-SDS.6N.V7**  
140583

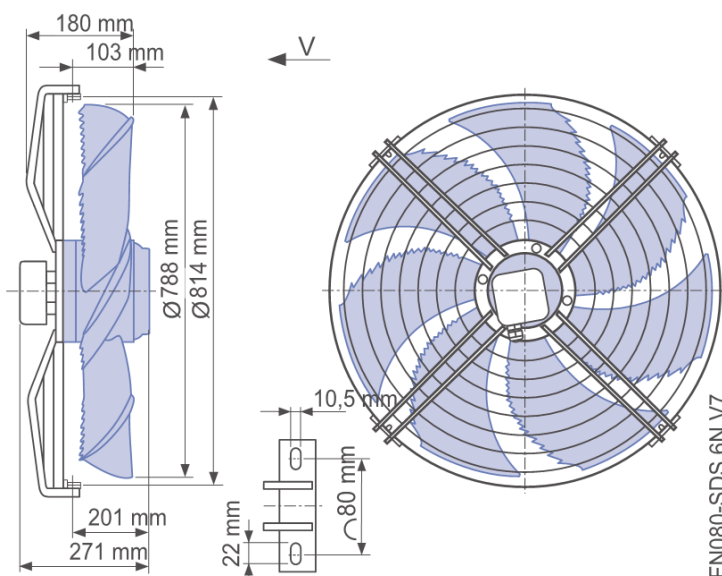

## wiring diagram

14.11.2024

version FANselect V 1.01 (241114), AMCA V 1.03 September, 2021<br>RLT V 1.00 Dezember, 2021 / 1.24.11.14 | 30813 | (user ZAFS20813)

1



**FN080-SDS.6N.V7**  
140583

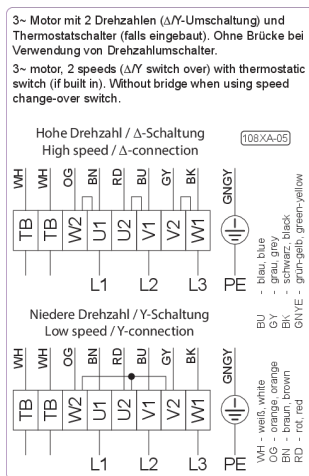



## system components

14.11.2024

Version FANselect V 1.01 (241114), AMCA V 1.03 September, 2021&lt;br&gt;RLT V 1.00 Dezember, 2021 / 1.24.11.14 | 30813 | (user ZAFS20813)



type	FN080-SDS.6N.V7
article no.	140583

<b>mechanical component</b>	backdraft fan shutter
	type: SVK800 article no.: 00264387
	guide vane
	type: Ø 800 article no.: 00291515