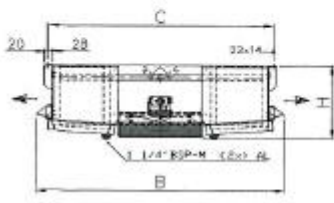
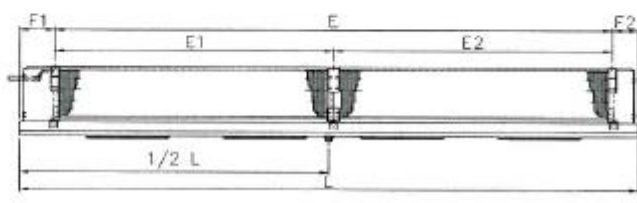

Referentie:

Verdampers (Goedhart)

Dubbelzijdig blazend DVS-44507 R-507 DE					
Selectiegegevens					
Capaciteit	kW	28,1	Koudemiddel		R-507 DE
Luchthoeveelheid	m³/h	29926	Verdampingstemperatuur	°C	-6,0
Lucht temperatuur In	°C	1,0 (85,0%)			
Lucht temperatuur Uit	°C	-0,9 (89,4%)	Vloeistoftemperatuur	°C	30,0
Rijplaat	mm	0,2			
Technische gegevens					
Lamel afstand	mm	7	Blok		Cu / Al
Oppervlakt	m²	182	Omkastling		gegalvaniseerd
Volume	dm³	46,0	Afwerking		Wit (RAL 9003)
Gewicht (leeg)	kg	395			
Ventilatorgegevens					
Aantal x diameter	mm	4x 500	Beschermingsklasse		IP44
Ventilator toerental	tpm	1380	Geluidsdruk - afstand	dB(A)-m	69 @ 3
Opgenomen vermogen	W	880			
Nominale stroom	A	1,9			
Fase - Spanning - Frequentie	V-Hz	3 - 400 - 50			
Afmetingen					
L - 4056 mm	E - 3656 mm	E3 - mm	F1 - 230 mm		
B - 1420 mm	E1 - 1828 mm	E4 - mm	F2 - 170 mm		
H - 520 mm	E2 - 1828 mm		C - 1280 mm		

Industrial air cooler DVS

Cooling and working rooms

Cu/Al - R404A

GEA Heat Exchangers



Goedhart



Goedhart DVS

The Goedhart DVS range of dual discharge ceiling mounted air coolers consists of 162 types with capacities between 3,1 and 151.7 kW. The aircoolers are especially suitable for cooling and working room applications. The height of the aircooler is low, so the maximum space in the chill room can be utilised. The coil block is standard build from aluminium end plates, copper tubes and aluminium fins. The fans are arranged for blow-through or draw-through air configuration (please state which is required when ordering). The modular design incorporates 5 different sizes of fan, with model options of up to 6 fans per cooler.

Type description

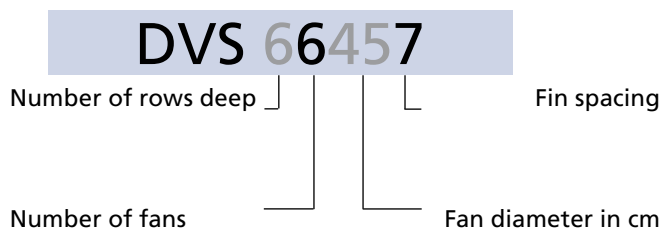

Coil execution

- Tube pitch : 50x50 mm straight
- Fin spacings : 4, 7, 10 mm
- Material : 15 mm o.d. copper tubes
- : aluminium HT-fins
- Goedhart DVS coil blocks have copper tubes mechanically expanded into fully collared aluminium fins, providing excellent thermal contact. All evaporator coils are pressure tested to 30 bars (lower by coolants) and supplied with a light overpressure charge.
- The coolers are suitable for the most commonly used refrigerants/coolants with the exception of NH3.

Casing

- Construction for ceiling mounting
- Casing material of galvanized sheet steel
- Finishing is standard white epoxy spray (RAL 9003)
- Bend/header protection by end covers, easy removed for maintenance
- 2 Hinged drip trays underneath each coil block.
- Defrost by hot gas spiral or electric defrost elements will be fixed to the bottom side of the coil.

General range features

Capacity

The listed nominal cooling capacities are based on R404A, DT1 and DTM and a RH of 85%.

Influence of coating on capacity

The use of coated fins, or of a fully coated coil will result in a capacity decrease of approximately 3%

Capacity optimisation

Since Goedhart tries to limit stock products, we are capable of optimising the circuitry of our evaporators. In order to do this, the following information is needed :

- Design capacity
- Air volume
- Refrigerant
- Air on temperature
- Evaporating temperature
- Liquid temperature before expansion valve.

Sound data

The mean sound pressure (LpA @ 3m ± 2 dB (A)) each air cooler is a calculated indication value according to the EN13487 standard parallel pipe. Goedhart uses the fan manufacturer's sound power level (LwA) at the inlet side of the fan. Changes to or by the fan or the product, affect the sound, in these cases, consult the manufacturer for the new indication value. In critical sound requirements, we advise you to consult an expert.

Defrost systems

For room temperatures where ice-build up can be expected and where the coil can not be defrosted by the room air, electric or hot gas defrost is necessary

Electrical defrost

On request Goedhart DVS can be provided with electrical defrost. The stainless steel heating elements are fitted in the coil block within aluminium tubes, which forms a highly conductive medium between the heaters and the fins. In the drip tray heater elements are fitted to the underside of the aluminium inner tray. The elements are rated for 220/240 V and are connected (IP55) for 380/415 V (with neutral) supply. The heater elements in the coil block are removable from the bend side, whilst the tray heater elements can be removed once the outer tray has been removed.

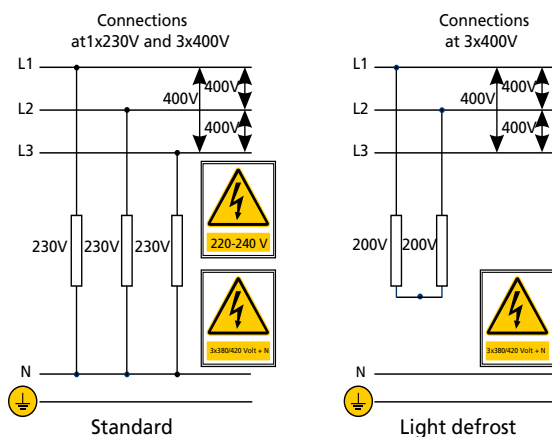

Hot gas defrost

The coil block is suited for hot gas defrost (hot gas supply through the suction header). The drip tray can be provided with a copper hot gas spiral. This is enclosed in aluminium profiles that are rigidly secured to the under side of the aluminium inner drip tray

Accessories:

Standard accessories for the Goedhart DVS aircoolers are:

- electric, hotgas defrost system.
- insulation in the space between the inner and outer drip tray.
- insulated hygienic polyester drip tray.
- insulated fanplate
- hinged fan plate
- single phase motors

The accessories are included in the price list.

Optional extras:

Various optional extras for the Goedhart DVS are available, price and delivery upon request:

- insulation discs
- 60 Hz motors
- water defrost system
- glycol/water/etc. cooling mediums
- stainless steel casing
- other fin spacings
- other fans (when external pressure is requested)

Mounting and Maintenance

Goedhart DVS is delivered on a wooden frame. When on the frame, Goedhart DVS can be handled by forklift truck, which makes positioning and installation simple. Refer to our maintenance and installation manual.

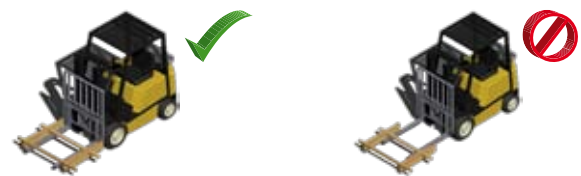

Fans

The manufacturer of the fans is Süd Electric (we reserve the right to alter the manufacturer). The fans have glass fibre reinforced polypropylene impellers. The motors are available for 400V-50Hz-3 phase or 230V-50Hz-1 phase electrical supply. 2-Speed regulation can be achieved at 400/690V-50Hz-3 phase by using a D-Y reconnection (fig. 1). 3 Phase motors are suitable for a frequency controller (A sinus filter is needed, fig. 2). 1 Phase motors are suitable for phase control and transformer. The motors are standard executed with a thermo contact. The fans are suitable for operation in air temperature applications between -40 °C and +45 °C. When the air temperature is lower than -40 °C, special fans are needed. These special fans have a longer delivery time. The technical data in the table below are the same as on the motor name plates and is valid for an air temperature of +40 °C.

For air temperatures lower than +40 °C, the current amperage can be calculated by using the diagram multiplication factor, suitable thermal overloads can then be selected.

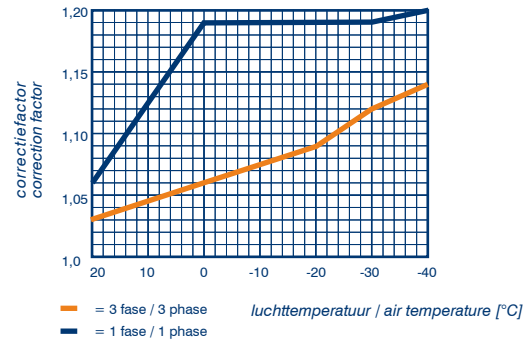

Three phase - 50 Hz

Fan type	Δ					Y			Protection class*	Fan heating
	Tension	Speed	Input	FLC	Sound power indication each fan LwA (+/-2dB(A))	Speed	Input	FLC		
	V	min ⁻¹	Watt	A	dB(A)	min ⁻¹	Watt	A		

4 pole motor (n=1500 rpm nom.)

400-32°	3x400/690	1350	250	0.60	74	1050	150	0.30	IP44	460
450-32°	3x400/690	1350	400	0.85	78	1050	300	0.50	IP44	580
500-40°	3x400/690	1380	880	1.90	85	1050	660	1.15	IP44	580
560-36°	3x400/690	1300	1250	2.30	85	1000	750	1.30	IP66	700
630-32°***	3x400/690	1300	1250	2.30	86	1000	750	1.30	IP66	820
630-28°***	3x230/400				88	1400	1400	2.50	IP66	820

6 pole motor (n=1000 rpm nom.)

400-28°	3x400/690	900	105	0.33	63	750	65	0.13	IP44	460
450-32°	3x400/690	900	180	0.40	69	750	120	0.20	IP44	580
500-40°	3x400/690	900	500	1.00	81	760	350	0.65	IP44	580
560-32°	3x400/690	880	680	1.60	75	680	400	0.90	IP66	700
630-36°	3x400/690	880	680	1.60	80	680	400	0.90	IP66	820

Single phase - 50 Hz

Ventilator type	Speed	Input	FLC	Protection class*
	min ⁻¹	Watt	A	

4 pole motor (n=1500 rpm nom.)

400-32°	1350	450	1.95	IP44
450-32°	1350	450	1.95	IP44
500-40°	1330	700	3.40	IP44
560-36°	1350	920	4.00	IP66
630-32°	1350	1300	7.10	IP66

6 pole motor (n=1000 rpm nom.)

400-28°	900	250	1.10	IP44
450-32°	900	250	1.10	IP44
500-40°	900	400	1.75	IP44
560-32°	870	700	3.40	IP66
630-36°	870	700	3.40	IP66

*= IP44 motors also available in IP66 execution (extra price)

**= Only cooling conditions

***= Only freezing conditions

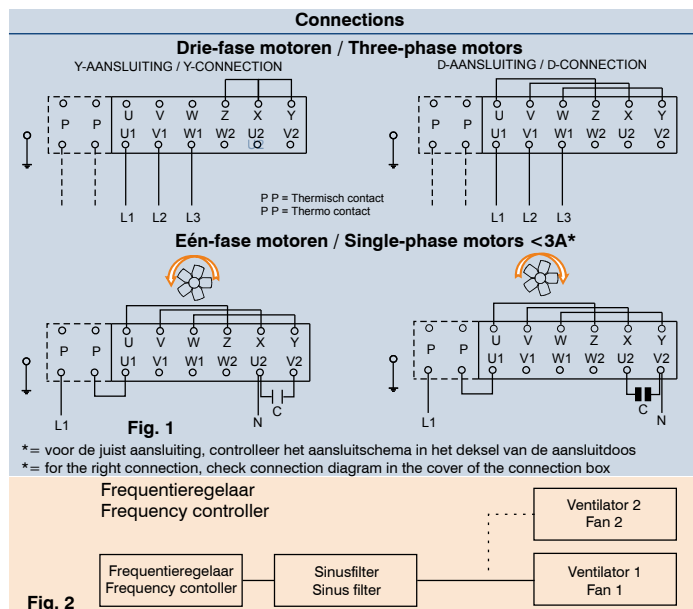

Correction factors

Capacities at DTM:

The capacities are based on R404A direct expansion and the difference between the mean air temperature and the evaporation temperature (DTM). The evaporation temperature is the saturated temperature corresponding to the pressure at the suction outlet of the cooler. The nominal capacities are based on evaporation temperatures of -5 °C, a DTM of 7 K and light frosting. Capacities for other mediums and systems are available upon request.

Correction factors for various mean air temperatures and evaporation temperatures (DTM) are as indicated in the tables below. The requested capacity must be multiplied by a correction factor from one of these tables.

$$Q_{\text{nominal}} = \text{factor} \times Q_{\text{requested}}$$

Capacities at DT1:

Hereby the capacities are based on R404A direct expansion and DT1. DT1 is the difference between air-on temperature and the evaporation temperature of the cooler. The evaporation temperature is the saturated temperature corresponding to the pressure at the suction outlet of the cooler. The nominal capacities are based on evaporation temperatures of -8 °C and DT1=8K and light frosting. Capacities for other mediums and systems are available upon request.

Correction factors for various air-on temperatures and temperature differences (DT1) are as indicated in the table below. The requested capacity must be multiplied by a correction factor from the table, so that a cooler with the resulting nominal capacity can be chosen from the selection tables.

$$Q_{\text{nominal}} = \text{factor} \times Q_{\text{requested}}$$

R404A light frost = 0.2 mm RH = 85%

DTM	Evaporation temperature (°C)							
	K	0	-2,5	-5	-7,5	-10	-12,5	-15
6		1.20	1.23	1.26	1.28	1.31	1.32	1.33
7		0.96	0.98	1.00	1.03	1.04	1.07	1.08
8		0.79	0.82	0.84	0.85	0.87	0.88	0.88
9		0.68	0.70	0.71	0.72	0.75	0.77	0.77
10		0.58	0.59	0.62	0.64			

Prices on request due to divergent circuits

DT1	Evaporation temperature (°C)							
	K	0	-2,5	-5	-7,5	-10	-12,5	-15
6		1.40	1.43	1.45	1.48	1.51	1.54	1.56
7		1.12	1.15	1.18	1.20	1.22	1.24	1.25
8		0.93	0.95	0.97	1.00	1.01	1.03	1.05
9		0.78	0.81	0.83	0.85	0.87	0.88	0.89
10		0.68	0.70	0.72	0.74	0.75	0.76	0.78
11		0.60	0.62	0.63	0.65			

Prices on request due to divergent circuits

 = calculated without frosting

 = calculated without frosting

R404A normal frost = 0.5 mm RH= 85%

DTM	Evaporation temperature (°C)							
	K	0	-2,5	-5	-7,5	-10	-12,5	-15
6			1.37	1.41	1.43	1.46	1.47	1.49
7			1.10	1.13	1.15	1.17	1.19	1.20
8			0.92	0.94	0.96	0.98	0.99	1.00
9				0.80	0.82	0.83	0.84	0.88
10				0.69	0.71	0.74	0.74	0.75
11				0.62	0.63	0.64		

Prices on request due to divergent circuits

DT1	Evaporation temperature (°C)							
	K	0	-2,5	-5	-7,5	-10	-12,5	-15
6			1.57	1.59	1.62	1.64	1.67	1.69
7			1.26	1.28	1.31	1.33	1.35	1.37
8			1.05	1.07	1.09	1.11	1.13	1.14
9				0.91	0.93	0.95	0.96	0.97
10				0.79	0.81	0.82	0.84	0.85
11				0.70	0.71	0.82	0.74	0.75
12				0.62	0.64	0.65		

Prices on request due to divergent circuits

ATTENTION !!!

When making your selection, pay attention to the ratio between the air volume and capacity. A low volume to capacity ratio results in a wide temperature drop across the coil which cause to dry out (especially on coils with a high number of rows deep).

The correction factors on this page have been calculated using a varying SHR (ratio of sensible heat load / total heat load). The chart left indicates the SHR values used in the calculations, in which dt is the difference between the air and evaporation temperatures. The SHR values have been based on entering air with a relative humidity of 85%.

Example:

- $t_o = -10 \text{ °C}$ and $dt = 10 \text{ K}$ resultant SHR value is 0.70
- $t_o = -10 \text{ °C}$ and $dt = 5 \text{ K}$ resultant SHR value is 0.82
- $t_o = -30 \text{ °C}$ and $dt = 10 \text{ K}$ resultant SHR value is 0.84
- $t_o = -30 \text{ °C}$ and $dt = 5 \text{ K}$ resultant SHR value is 0.98

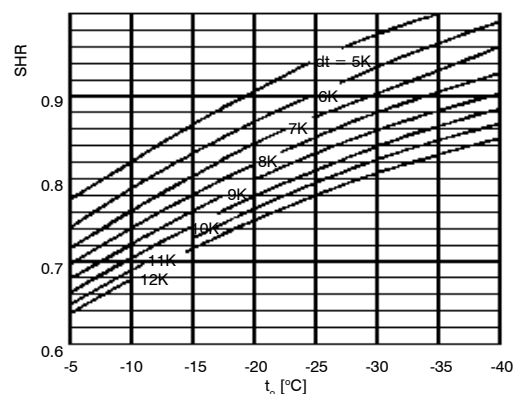

DVS Electrical defrost

Type	Fan	Light defrost					Heavy defrost				
		Coil (230V)		Drip tray (200V)		Total	Coil (230V)		Drip tray (200V)		Total
		number	kW	number	kW	kW	number	kW	number	kW	kW



4 fans

3.4.45.f	Ø450	2 (2x)	8.80	1 (2x)	3.74	12.54	3 (2x)	13.20	1 (2x)	3.74	16.94
4.4.45.f		2 (2x)	8.80	1 (2x)	3.74	12.54	3 (2x)	13.20	1 (2x)	3.74	16.94
6.4.45.f		2 (2x)	8.80	1 (2x)	3.74	12.54	3 (2x)	13.20	1 (2x)	3.74	16.94
8.4.45.f		2 (2x)	8.80	1 (2x)	3.74	12.54	4 (2x)	17.60	1 (2x)	3.74	21.34
1.4.45.f		3 (2x)	13.20	1 (2x)	3.92	17.12	5 (2x)	22.00	1 (2x)	3.92	25.92
3.4.50.f	Ø500	4 (2x)	12.40	2 (2x)	5.48	17.88	6 (2x)	18.60	2 (2x)	5.48	24.08
4.4.50.f		4 (2x)	12.40	2 (2x)	5.48	17.88	6 (2x)	18.60	2 (2x)	5.48	24.08
6.4.50.f		4 (2x)	12.40	2 (2x)	5.48	17.88	6 (2x)	18.60	2 (2x)	5.48	24.08
8.4.50.f		4 (2x)	12.40	2 (2x)	5.48	17.88	8 (2x)	24.80	2 (2x)	5.48	30.28
1.4.50.f		6 (2x)	18.60	2 (2x)	5.48	24.08	10 (2x)	31.00	2 (2x)	5.48	36.48
3.4.56.f	Ø560	4 (2x)	14.48	2 (2x)	5.84	20.32	6 (2x)	21.72	2 (2x)	5.84	27.56
4.4.56.f		4 (2x)	14.48	2 (2x)	5.84	20.32	6 (2x)	21.72	2 (2x)	5.84	27.56
6.4.56.f		4 (2x)	14.48	2 (2x)	5.84	20.32	6 (2x)	21.72	2 (2x)	5.84	27.56
8.4.56.f		4 (2x)	14.48	2 (2x)	5.84	20.32	8 (2x)	28.96	2 (2x)	5.84	34.80
1.4.56.f		6 (2x)	21.72	2 (2x)	5.84	27.56	10 (2x)	36.20	2 (2x)	5.84	42.04
3.4.63.f	Ø630	4 (2x)	14.48	2 (2x)	5.84	20.32	6 (2x)	21.72	2 (2x)	5.84	27.56
4.4.63.f		4 (2x)	14.48	2 (2x)	5.84	20.32	6 (2x)	21.72	2 (2x)	5.84	27.56
6.4.63.f		4 (2x)	14.48	2 (2x)	5.84	20.32	6 (2x)	21.72	2 (2x)	5.84	27.56
8.4.63.f		6 (2x)	21.72	2 (2x)	5.84	27.56	10 (2x)	36.20	2 (2x)	5.84	42.04
1.4.63.f		6 (2x)	21.72	2 (2x)	5.84	27.56	10 (2x)	36.20	2 (2x)	5.84	42.04



5 fans

3.5.50.f	Ø500	4 (2x)	15.52	2 (2x)	6.68	22.20	6 (2x)	23.28	2 (2x)	6.68	29.96
4.5.50.f		4 (2x)	15.52	2 (2x)	6.68	22.20	6 (2x)	23.28	2 (2x)	6.68	29.96
6.5.50.f		4 (2x)	15.52	2 (2x)	6.68	22.20	6 (2x)	23.28	2 (2x)	6.68	29.96
8.5.50.f		4 (2x)	15.52	2 (2x)	6.68	22.20	8 (2x)	31.04	2 (2x)	6.68	37.72
1.5.50.f		6 (2x)	23.28	2 (2x)	6.68	29.96	10 (2x)	38.80	2 (2x)	6.68	45.48
3.5.56.f	Ø560	4 (2x)	17.60	2 (2x)	7.04	24.64	6 (2x)	26.40	2 (2x)	7.04	33.44
4.5.56.f		4 (2x)	17.60	2 (2x)	7.04	24.64	6 (2x)	26.40	2 (2x)	7.04	33.44
6.5.56.f		4 (2x)	17.60	2 (2x)	7.04	24.64	6 (2x)	26.40	2 (2x)	7.04	33.44
8.5.56.f		4 (2x)	17.60	2 (2x)	7.04	24.64	8 (2x)	35.20	2 (2x)	7.04	42.24
1.5.56.f		6 (2x)	26.40	2 (2x)	7.04	33.44	10 (2x)	44.00	2 (2x)	7.04	51.04
3.5.63.f	Ø630	4 (2x)	17.60	2 (2x)	7.04	24.64	6 (2x)	26.40	2 (2x)	7.04	33.44
4.5.63.f		4 (2x)	17.60	2 (2x)	7.04	24.64	6 (2x)	26.40	2 (2x)	7.04	33.44
6.5.63.f		4 (2x)	17.60	2 (2x)	7.04	24.64	6 (2x)	26.40	2 (2x)	7.04	33.44
8.5.63.f		6 (2x)	26.40	2 (2x)	7.04	33.44	10 (2x)	44.00	2 (2x)	7.04	51.04
1.5.63.f		6 (2x)	26.40	2 (2x)	7.04	33.44	10 (2x)	44.00	2 (2x)	7.04	51.04



6 fans

3.6.50.f	Ø500	4 (2x)	18.64	2 (2x)	7.84	26.48	6 (2x)	27.96	2 (2x)	7.84	35.80
4.6.50.f		4 (2x)	18.64	2 (2x)	7.84	26.48	6 (2x)	27.96	2 (2x)	7.84	35.80
6.6.50.f		4 (2x)	18.64	2 (2x)	7.84	26.48	6 (2x)	27.96	2 (2x)	7.84	35.80
8.6.50.f		4 (2x)	18.64	2 (2x)	7.84	26.48	8 (2x)	37.28	2 (2x)	7.84	45.12
1.6.50.f		6 (2x)	27.96	2 (2x)	7.84	35.80	10 (2x)	46.60	2 (2x)	7.84	54.44
3.6.56.f	Ø560	4 (2x)	20.80	2 (2x)	8.32	29.12	6 (2x)	31.20	2 (2x)	8.32	39.52
4.6.56.f		4 (2x)	20.80	2 (2x)	8.32	29.12	6 (2x)	31.20	2 (2x)	8.32	39.52
6.6.56.f		4 (2x)	20.80	2 (2x)	8.32	29.12	6 (2x)	31.20	2 (2x)	8.32	39.52
8.6.56.f		4 (2x)	20.80	2 (2x)	8.32	29.12	8 (2x)	41.60	2 (2x)	8.32	49.92
1.6.56.f		6 (2x)	31.40	2 (2x)	8.32	39.52	10 (2x)	52.00	2 (2x)	8.32	60.32
3.6.63.f	Ø630	4 (2x)	20.80	2 (2x)	8.32	29.12	6 (2x)	31.20	2 (2x)	8.32	39.52
4.6.63.f		4 (2x)	20.80	2 (2x)	8.32	29.12	6 (2x)	31.20	2 (2x)	8.32	39.52
6.6.63.f		4 (2x)	20.80	2 (2x)	8.32	29.12	6 (2x)	31.20	2 (2x)	8.32	39.52
8.6.63.f		6 (2x)	31.40	2 (2x)	8.32	39.52	10 (2x)	52.00	2 (2x)	8.32	60.32
1.6.63.f		6 (2x)	31.70	2 (2x)	8.32	39.52	10 (2x)	52.00	2 (2x)	8.32	60.32

f = fin spacing

Goedhart standard product information

Goedhart standard aircooler overview



VCI



DVS/DRS/DZS



ZGB/ZGZ



PAC



FC38



ZFB/ZFZ



Goedhart air cooler for every application

For Contractors and Original Equipment Manufacturers (OEM) related to the industrial refrigeration industry, GEA Goedhart B.V. offers an unlimited range of air coolers and air cooled condensers in several configurations.

Depending on the application, the optimum configuration will be selected in close cooperation with our customers.

Configurations

The following material combinations are available in various tube pitches and various fin spacing:

Tube material	Tube configuration	Fin material
Copper (Cu)	38x33, 50x50, 60x60	Aluminium (Al)
Stainless steel (Stst)	38x33, 50x50, 60x60	Aluminium (Al)
Stainless steel (Stst)	50x50	Stainless steel (Stst)
Aluminium (Al)	60x60	Aluminium (Al)
Hot dipped galvanized steel (FeZn)	60x60, 75x75	Hot dipped galvanized steel (FeZn)

Options on aluminium fins

- Goldlack coated fins
- Seawater resistant aluminium fins (AlMg)

Applications

Cooling	Freezing
Cold stores / Distribution centres	Cold stores / Distribution centres
Food processing rooms	Tunnel / spiral freezers
Fruit storage	Slaughter houses
Banana ripening storage	Automotive testing rooms
Greenhouse conditioning	Ski domes

Pressure Equipment Directive (P.E.D.)

All aircoolers produced by Goedhart comply with the Pressure Equipment Directive 97/23/EC. PED certificates can be downloaded from www.goedhart.nl.





GEA Heat Exchangers

GEA Goedhart B.V.

Nijverheidsweg 6, 4695 RC Sint Maartensdijk
the Netherlands
Phone +31 (0)166 665 665, Fax+31 (0)166 663 698
www.goedhart.nl
info.goedhart.nl@geagroup.com

GEA Heat Exchangers

GEA Goedhart s.r.o.

Kostomlátecká 180, 288 26 Nymburk
Czech Republic
Phone +420 (0)325 819 951, Fax+420 (0)325 519 952
www.goedhart.cz
goedhart.cz@geagroup.com

03.01.2.009.doc 2010-01 / Subject to modification

All offers, contracts, deliveries and other legal relations from GEA Goedhart B.V. are subject to the latest version of our general sales and delivery conditions as filed at the Chamber of Commerce in Middelburg - The Netherlands

Applicability of the general conditions put forward by any buyer is rejected explicitly by GEA Goedhart B.V.