

# Industrial air cooler DVS

## Cooling and working rooms

Cu/Al - R404A

GEA Heat Exchangers



Goedhart



# Goedhart DVS

The Goedhart DVS range of dual discharge ceiling mounted air coolers consists of 162 types with capacities between 3,1 and 151.7 kW. The aircoolers are especially suitable for cooling and working room applications. The height of the aircooler is low, so the maximum space in the chill room can be utilised. The coil block is standard build from aluminium end plates, copper tubes and aluminium fins. The fans are arranged for blow-through or draw-through air configuration (please state which is required when ordering). The modular design incorporates 5 different sizes of fan, with model options of up to 6 fans per cooler.

## Coil execution

- Tube pitch : 50x50 mm straight
- Fin spacings : 4, 7, 10 mm
- Material : 15 mm o.d. copper tubes
- : aluminium HT-fins
- Goedhart DVS coil blocks have copper tubes mechanically expanded into fully collared aluminium fins, providing excellent thermal contact. All evaporator coils are pressure tested to 30 bars (lower by coolants) and supplied with a light overpressure charge.
- The coolers are suitable for the most commonly used refrigerants/coolants with the exception of NH3.

## Type description

**DVS 66457**

Number of rows deep

Fin spacing

Number of fans

Fan diameter in cm

## Casing

- Construction for ceiling mounting
- Casing material of galvanized sheet steel
- Finishing is standard white epoxy spray (RAL 9003)
- Bend/header protection by end covers, easy removed for maintenance
- 2 Hinged drip trays underneath each coil block.
- Defrost by hot gas spiral or electric defrost elements will be fixed to the bottom side of the coil.

# General range features

## Capacity

The listed nominal cooling capacities are based on R404A , DT1 and DTM and a RH of 85%.

### Influence of coating on capacity

The use of coated fins, or of a fully coated coil will result in a capacity decrease of approximately 3%

### Capacity optimisation

Since Goedhart tries to limit stock products, we are capable of optimising the circuitry of our evaporators. In order to do this, the following information is needed :

- Design capacity
- Air volume
- Refrigerant
- Air on temperature
- Evaporating temperature
- Liquid temperature before expansion valve.

## Sound data

The mean sound pressure (LpA @ 3m ± 2 dB (A)) each air cooler is a calculated indication value according to the EN13487 standard parallel pipe. Goedhart uses the fan manufacturer's sound power level (LwA) at the inlet side of the fan. Changes to or by the fan or the product, affect the sound, in these cases, consult the manufacturer for the new indication value. In critical sound requirements, we advise you to consult an expert.

## Defrost systems

For room temperatures where ice-build up can be expected and where the coil can not be defrosted by the room air, electric or hot gas defrost is necessary

### Electrical defrost

On request Goedhart DVS can be provided with electrical defrost. The stainless steel heating elements are fitted in the coil block within aluminium tubes, which forms a highly conductive medium between the heaters and the fins. In the drip tray heater elements are fitted to the underside of the aluminium inner tray. The elements are rated for 220/240 V and are connected (IP55) for 380/415 V (with neutral) supply. The heater elements in the coil block are removable from the bend side, whilst the tray heater elements can be removed once the outer tray has been removed.

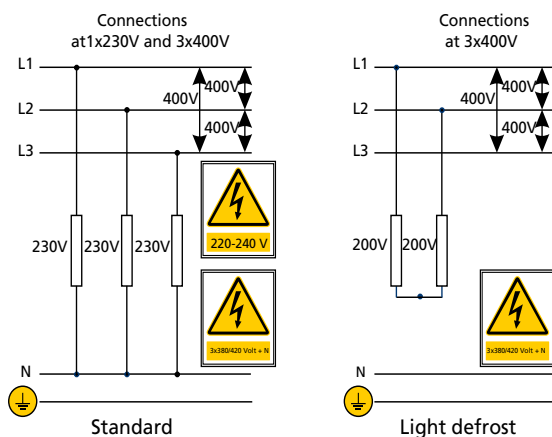

### Hot gas defrost

The coil block is suited for hot gas defrost ( hot gas supply through the suction header). The drip tray can be provided with a copper hot gas spiral. This is enclosed in aluminium profiles that are rigidly secured to the under side of the aluminium inner drip tray

## Accessories:

Standard accessories for the Goedhart DVS aircoolers are:

- electric, hotgas defrost system.
- insulation in the space between the inner and outer drip tray.
- insulated hygienic polyester drip tray.
- insulated fanplate
- hinged fan plate
- single phase motors

The accessories are included in the price list.

## Optional extras:

Various optional extras for the Goedhart DVS are available, price and delivery upon request:

- insulation discs
- 60 Hz motors
- water defrost system
- glycol/water/etc. cooling mediums
- stainless steel casing
- other fin spacings
- other fans (when external pressure is requested)

## Mounting and Maintenance

Goedhart DVS is delivered on a wooden frame. When on the frame, Goedhart DVS can be handled by forklift truck, which makes positioning and installation simple. Refer to our maintenance and installation manual.

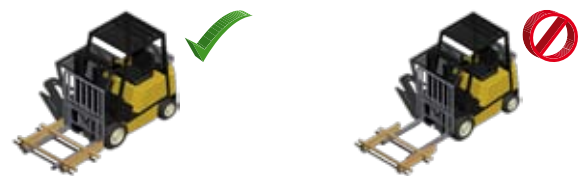

# Fans

The manufacturer of the fans is Süd Electric (we reserve the right to alter the manufacturer). The fans have glass fibre reinforced polypropylene impellers. The motors are available for 400V-50Hz-3 phase or 230V-50Hz-1 phase electrical supply. 2-Speed regulation can be achieved at 400/690V-50Hz-3 phase by using a D-Y reconnection (fig. 1). 3 Phase motors are suitable for a frequency controller (A sinus filter is needed, fig. 2). 1 Phase motors are suitable for phase control and transformer. The motors are standard executed with a thermo contact. The fans are suitable for operation in air temperature applications between -40 oC and +45 oC. When the air temperature is lower then -40 °C , special fans are needed. These speciale fans have a longer delivery time. The technical data in the table below are the same as on the motor name plates and is valid for an air temperature of +40 °C.

For air temperatures lower then +40 oC, the current amperage can be calculated by using the diagram multiplication factor, suitable thermal overloads can then be selected.

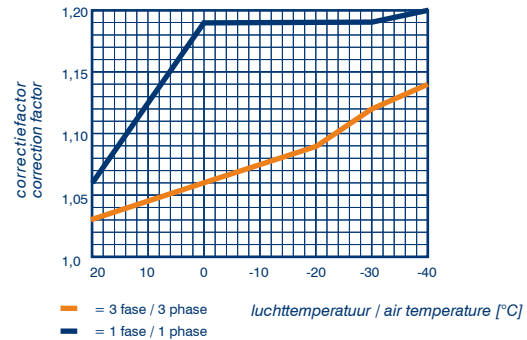

## Three phase - 50 Hz

Fan type	Δ					Y			Protection class*	Fan heating
	Tension	Speed	Input	FLC	Sound power indication each fan LwA (+/-2dB(A))	Speed	Input	FLC		
	V	min <sup>-1</sup>	Watt	A	dB(A)	min <sup>-1</sup>	Watt	A		

### 4 pole motor (n=1500 rpm nom.)

400-32°	3x400/690	1350	250	0.60	74	1050	150	0.30	IP44	460
450-32°	3x400/690	1350	400	0.85	78	1050	300	0.50	IP44	580
500-40°	3x400/690	1380	880	1.90	85	1050	660	1.15	IP44	580
560-36°	3x400/690	1300	1250	2.30	85	1000	750	1.30	IP66	700
630-32°***	3x400/690	1300	1250	2.30	86	1000	750	1.30	IP66	820
630-28°***	3x230/400				88	1400	1400	2.50	IP66	820

### 6 pole motor (n=1000 rpm nom.)

400-28°	3x400/690	900	105	0.33	63	750	65	0.13	IP44	460
450-32°	3x400/690	900	180	0.40	69	750	120	0.20	IP44	580
500-40°	3x400/690	900	500	1.00	81	760	350	0.65	IP44	580
560-32°	3x400/690	880	680	1.60	75	680	400	0.90	IP66	700
630-36°	3x400/690	880	680	1.60	80	680	400	0.90	IP66	820

## Single phase - 50 Hz

Ventilator type	Speed	Input	FLC	Protection class*
	min <sup>-1</sup>	Watt	A	

### 4 pole motor (n=1500 rpm nom.)

400-32°	1350	450	1.95	IP44
450-32°	1350	450	1.95	IP44
500-40°	1330	700	3.40	IP44
560-36°	1350	920	4.00	IP66
630-32°	1350	1300	7.10	IP66

### 6 pole motor (n=1000 rpm nom.)

400-28°	900	250	1.10	IP44
450-32°	900	250	1.10	IP44
500-40°	900	400	1.75	IP44
560-32°	870	700	3.40	IP66
630-36°	870	700	3.40	IP66

\*= IP44 motors also available in IP66 execution (extra price)

\*\*= Only cooling conditions

\*\*\*= Only freezing conditions

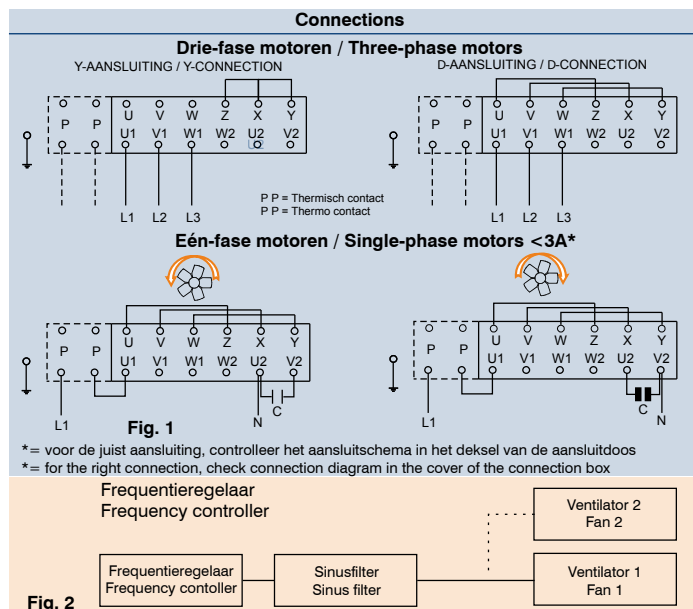

# Correction factors

## Capacities at DTM:

The capacities are based on R404A direct expansion and the difference between the mean air temperature and the evaporation temperature (DTM). The evaporation temperature is the saturated temperature corresponding to the pressure at the suction outlet of the cooler. The nominal capacities are based on evaporation temperatures of -5 °C, a DTM of 7 K and light frosting. Capacities for other mediums and systems are available upon request.

Correction factors for various mean air temperatures and evaporation temperatures (DTM) are as indicated in the tables below. The requested capacity must be multiplied by a correction factor from one of these tables.

$$Q_{\text{nominal}} = \text{factor} \times Q_{\text{requested}}$$

## Capacities at DT1:

Hereby the capacities are based on R404A direct expansion and DT1. DT1 is the difference between air-on temperature and the evaporation temperature of the cooler. The evaporation temperature is the saturated temperature corresponding to the pressure at the suction outlet of the cooler. The nominal capacities are based on evaporation temperatures of -8 °C and DT1=8K and light frosting. Capacities for other mediums and systems are available upon request.

Correction factors for various air-on temperatures and temperature differences (DT1) are as indicated in the table below. The requested capacity must be multiplied by a correction factor from the table, so that a cooler with the resulting nominal capacity can be chosen from the selection tables.

$$Q_{\text{nominal}} = \text{factor} \times Q_{\text{requested}}$$

### R404A light frost = 0.2 mm RH = 85%

DTM K	Evaporation temperature (°C)						
	0	-2,5	-5	-7,5	-10	-12,5	-15
6	1.20	1.23	1.26	1.28	1.31	1.32	1.33
7	0.96	0.98	1.00	1.03	1.04	1.07	1.08
8	0.79	0.82	0.84	0.85	0.87	0.88	0.88
9	0.68	0.70	0.71	0.72	0.75	0.77	0.77
10	0.58	0.59	0.62	0.64			

Prices on request due to divergent circuits

DT1 K	Evaporation temperature (°C)						
	0	-2,5	-5	-7,5	-10	-12,5	-15
6	1.40	1.43	1.45	1.48	1.51	1.54	1.56
7	1.12	1.15	1.18	1.20	1.22	1.24	1.25
8	0.93	0.95	0.97	1.00	1.01	1.03	1.05
9	0.78	0.81	0.83	0.85	0.87	0.88	0.89
10	0.68	0.70	0.72	0.74	0.75	0.76	0.78
11	0.60	0.62	0.63	0.65			

Prices on request due to divergent circuits

  = calculated without frosting

  = calculated without frosting

### R404A normal frost = 0.5 mm RH= 85%

DTM K	Evaporation temperature (°C)						
	0	-2,5	-5	-7,5	-10	-12,5	-15
6		1.37	1.41	1.43	1.46	1.47	1.49
7		1.10	1.13	1.15	1.17	1.19	1.20
8		0.92	0.94	0.96	0.98	0.99	1.00
9			0.80	0.82	0.83	0.84	0.88
10			0.69	0.71	0.74	0.74	0.75
11			0.62	0.63	0.64		

Prices on request due to divergent circuits

DT1 K	Evaporation temperature (°C)						
	0	-2,5	-5	-7,5	-10	-12,5	-15
6		1.57	1.59	1.62	1.64	1.67	1.69
7		1.26	1.28	1.31	1.33	1.35	1.37
8		1.05	1.07	1.09	1.11	1.13	1.14
9			0.91	0.93	0.95	0.96	0.97
10			0.79	0.81	0.82	0.84	0.85
11			0.70	0.71	0.82	0.74	0.75
12			0.62	0.64	0.65		

Prices on request due to divergent circuits

#### ATTENTION !!!

When making your selection, pay attention to the ratio between the air volume and capacity. A low volume to capacity ratio results in a wide temperature drop across the coil which cause to dry out (especially on coils with a high number of rows deep).

The correction factors on this page have been calculated using a varying SHR (ratio of sensible heat load / total heat load). The chart left indicates the SHR values used in the calculations, in which dt is the difference between the air and evaporation temperatures. The SHR values have been based on entering air with a relative humidity of 85%.

Example:

- $t_o = -10$  °C and dt = 10 K resultant SHR value is 0.70
- $t_o = -10$  °C and dt = 5 K resultant SHR value is 0.82
- $t_o = -30$  °C and dt = 10 K resultant SHR value is 0.84
- $t_o = -30$  °C and dt = 5 K resultant SHR value is 0.98

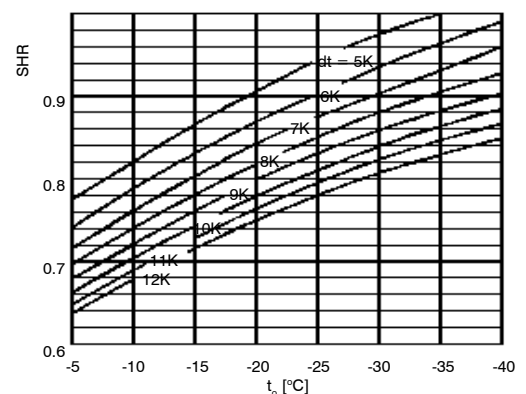

# DVS 4mm Technical data

Type DVS	3x400V-50H-4pole (1500 min <sup>-1</sup> nom.)				3x400V-50H-6pole (1000 min <sup>-1</sup> nom.)				Surface	Internally volume	Weight	Dimensions							Connections			
	R404A		Air volume	LpA @ 3 m (+/-2 dB(A))*	R404A		Air volume	LpA @ 3 m (+/-2 dB(A))*				L	B	H	E1	E2	E3	E4	Refrigerant			Drain
	DTM = 7K Air mean = +2°C	DT1 = 8K (SC2) Air on = 0°C			DTM = 7K Air mean = +2°C	DT1 = 8K (SC2) Air on = 0°C													in	out	Hot gas	
	kW	kW	m <sup>3</sup> /h	dB(A)	kW	kW	m <sup>3</sup> /h	dB(A)				mm	mm	mm	mm	mm	mm	mm	mm	mm	mm	NW"

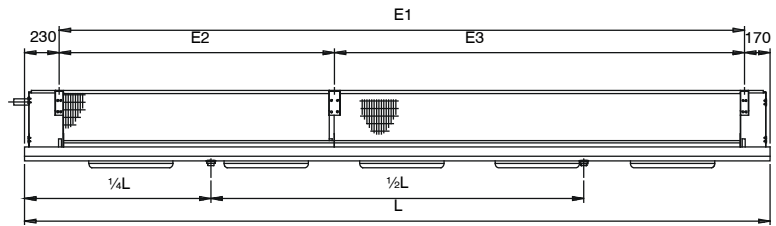
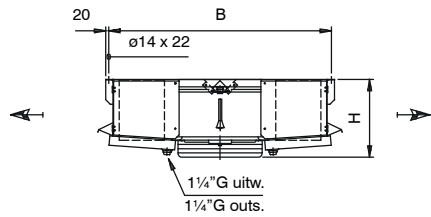

4.1.40.4	5,6	4,9	3082	52	5,1	1892	41	39	6	100	1056	1180	420	656			15	15	4x19	2x1 1/4"
6.1.40.4	9,2	6,6	2837	52	7,6	1790	41	58	10	120	1056	1380	420	656			22	12	4x19	2x1 1/4"
4.1.45.4	9,2	7,8	4610	56	7,8	2901	47	52	8	114	1056	1230	520	656			22	12	4x19	2x1 1/4"
6.1.45.4	12,9	9,3	4239	56	10,4	2632	47	78	12	140	1056	1430	520	656			22	12	4x19	2x1 1/4"
4.1.50.4	11,6	10,2	6946	63	10,6	4599	59	78	12	147	1356	1280	520	956			22	12	4x19	2x1 1/4"
6.1.50.4	19,2	14,5	6527	63	16,5	4315	59	117	18	182	1356	1480	520	956			28	16	4x19	2x1 1/4"
4.1.56.4	19,2	16,4	9904	63	16,7	6294	53	108	16	182	1456	1340	620	1056			28	16	4x19	2x1 1/4"
6.1.56.4	27,3	20,3	9381	63	22,7	5942	53	162	24	226	1456	1540	620	1056			35	16	4x19	2x1 1/4"
4.1.63.4	22,1	19,0	12071	63	20,3	8820	58	130	20	203	1456	1410	720	1056			35	16	4x19	2x1 1/4"
6.1.63.4	32,6	24,4	11387	63	28,2	8283	58	195	30	254	1456	1610	720	1056			35	16	4x19	2x1 1/4"

4.2.40.4	13,2	10,9	6152	55	11,0	3779	44	77	12	154	1656	1180	420	1256			22	12	4x19	2x1 1/4"
6.2.40.4	18,3	13,2	5660	55	15,1	3574	44	116	18	191	1656	1380	420	1256			28	12	4x19	2x1 1/4"
4.2.45.4	18,3	15,5	9206	59	15,6	5791	50	103	16	178	1656	1230	520	1256			28	16	4x19	2x1 1/4"
6.2.45.4	25,6	18,5	8458	59	20,6	5250	50	155	24	222	1656	1430	520	1256			35	16	4x19	2x1 1/4"
4.2.50.4	24,7	21,4	13882	66	22,4	9191	62	155	24	246	2256	1280	520	1856			35	16	4x19	2x1 1/4"
6.2.50.4	39,4	28,8	13039	66	33,1	8621	62	233	34	306	2256	1480	520	1856			35	16	4x19	2x1 1/4"
4.2.56.4	39,7	33,2	19794	66	33,7	12580	56	216	32	304	2456	1340	620	2056			42	16	4x19	2x1 1/4"
6.2.56.4	55,8	40,9	18745	66	45,7	11873	55	324	48	386	2456	1540	620	2056			42	22	4x19	2x1 1/4"
4.2.63.4	46,3	39,4	24125	66	42,4	17627	60	259	38	341	2456	1410	720	2056			42	16	4x19	2x1 1/4"
6.2.63.4	65,5	49,4	22752	66	58,3	16550	60	388	58	436	2456	1610	720	2056			42	22	4x19	2x1 1/4"

4.3.45.4	24,7	21,3	13799	61	22,1	8679	51	155	24	244	2256	1230	520	1856			35	16	4x19	2x1 1/4"
6.3.45.4	39,0	28,4	12678	61	31,7	7868	51	233	34	304	2256	1430	520	1856			35	16	4x19	2x1 1/4"
4.3.50.4	42,9	35,7	20816	67	37,3	13783	63	233	34	344	3156	1280	520	2756			42	16	4x19	2x1 1/4"
6.3.50.4	60,0	43,6	19551	67	50,3	12926	63	349	52	435	3156	1480	520	2756			42	22	4x19	2x1 1/4"
4.3.56.4	58,7	49,6	29685	67	51,2	18864	57	323	48	430	3456	1340	620	3056	1028	2028	54	22	4x19	2x1 1/4"
6.3.56.4	82,8	62,1	28111	67	69,4	17803	57	485	72	546	3456	1540	620	3056	1028	2028	54	22	4x19	2x1 1/4"
4.3.63.4	70,9	59,9	36180	67	64,6	26433	62	388	58	481	3456	1410	720	3056	1028	2028	54	22	4x19	2x1 1/4"
6.3.63.4	99,7	74,9	34117	67	88,7	24816	62	582	86	617	3456	1610	720	3056	1028	2028	54	22	4x19	2x1 1/4"

Pay attention to the relation capacity / air volume !!

\* Sound pressure indication (LpA) at 3 m distance each air cooler (+/- 2 dB(A)), free field conditions, according EN13487

# Goedhart standard product information

## Goedhart standard aircooler overview



VCI



DVS/DRS/DZS



ZGB/ZGZ



PAC



FC38



ZFB/ZFZ



# Goedhart air cooler for every application

For Contractors and Original Equipment Manufacturers (OEM) related to the industrial refrigeration industry, GEA Goedhart B.V. offers an unlimited range of air coolers and air cooled condensers in several configurations.

Depending on the application, the optimum configuration will be selected in close cooperation with our customers.

## Configurations

The following material combinations are available in various tube pitches and various fin spacing:

Tube material	Tube configuration	Fin material
Copper (Cu)	38x33, 50x50, 60x60	Aluminium (Al)
Stainless steel (Stst)	38x33, 50x50, 60x60	Aluminium (Al)
Stainless steel (Stst)	50x50	Stainless steel (Stst)
Aluminium (Al)	60x60	Aluminium (Al)
Hot dipped galvanized steel (FeZn)	60x60, 75x75	Hot dipped galvanized steel (FeZn)

## Options on aluminium fins

- Goldlack coated fins
- Seawater resistant aluminium fins (AlMg)

## Applications

Cooling	Freezing
Cold stores / Distribution centres	Cold stores / Distribution centres
Food processing rooms	Tunnel / spiral freezers
Fruit storage	Slaughter houses
Banana ripening storage	Automotive testing rooms
Greenhouse conditioning	Ski domes

## Pressure Equipment Directive (P.E.D.)

All aircoolers produced by Goedhart comply with the Pressure Equipment Directive 97/23/EC. PED certificates can be downloaded from [www.goedhart.nl](http://www.goedhart.nl).







GEA Heat Exchangers

## GEA Goedhart B.V.

Nijverheidsweg 6, 4695 RC Sint Maartensdijk  
the Netherlands  
Phone +31 (0)166 665 665, Fax+31 (0)166 663 698  
[www.goedhart.nl](http://www.goedhart.nl)  
[info.goedhart.nl@geagroup.com](mailto:info.goedhart.nl@geagroup.com)

GEA Heat Exchangers

## GEA Goedhart s.r.o.

Kostomlátecká 180, 288 26 Nymburk  
Czech Republic  
Phone +420 (0)325 819 951, Fax+420 (0)325 519 952  
[www.goedhart.cz](http://www.goedhart.cz)  
[goedhart.cz@geagroup.com](mailto:goedhart.cz@geagroup.com)

03.01.2.009.doc 2010-01 / Subject to modification

All offers, contracts, deliveries and other legal relations from GEA Goedhart B.V. are subject to the latest version of our general sales and delivery conditions as filed at the Chamber of Commerce in Middelburg - The Netherlands

Applicability of the general conditions put forward by any buyer is rejected explicitly by GEA Goedhart B.V.