

**HELPMAN**

000201

55.21  
1  
06-89

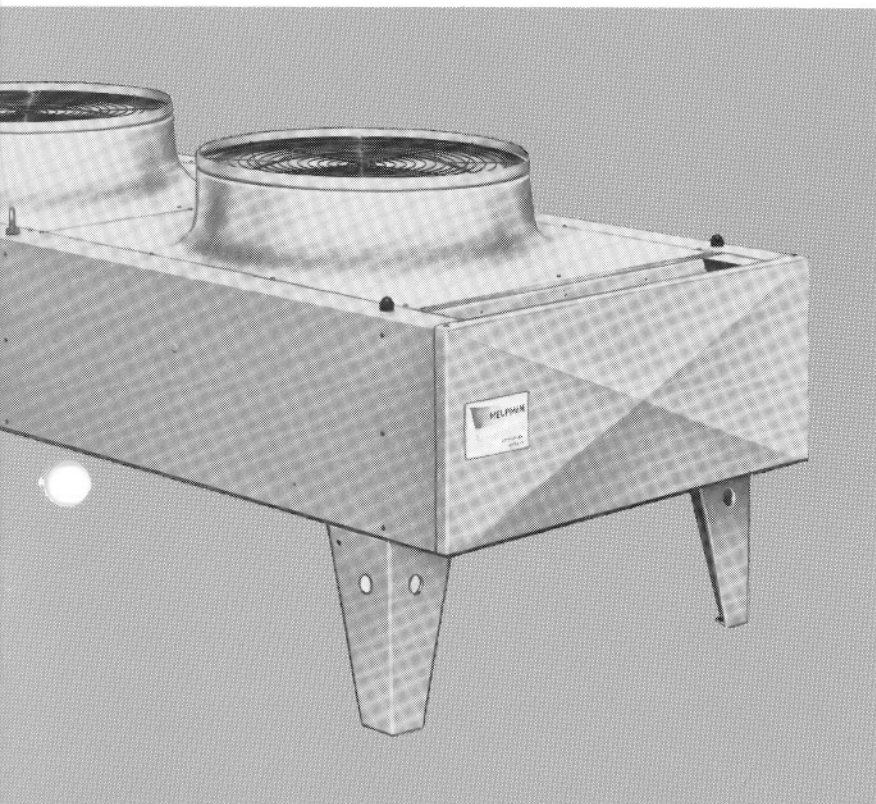

Aircooled  
condensers

LCY



## Aircooled condensers

# LCY

### Contents

---

**Page**

4-5-6	General information
7	Technical data
8	Capacity Calculation factors
9	Soundlevels
10	Dimensions vertical airflow
11-12	Dimensions horizontal airflow
13	Coupling headers Extra high feet
14	Mounting Transport

---

## Aircooled condensers

## LCY

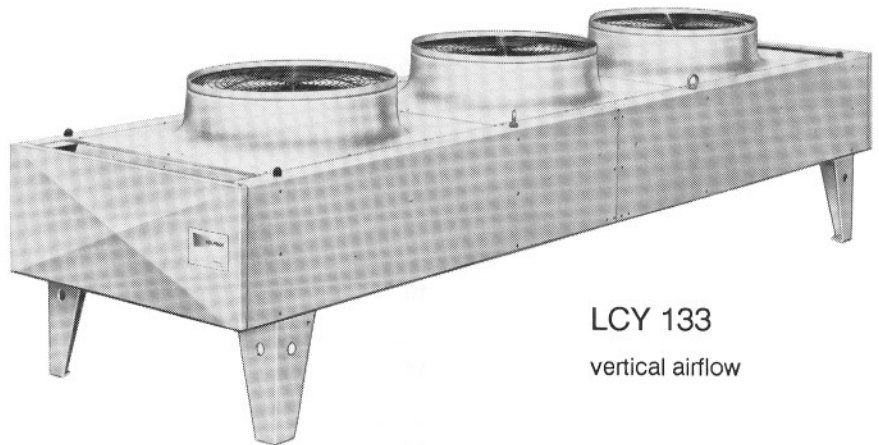
**LCY 133**

vertical airflow

### Range

The LCY aircooled condenser range includes 16 models with 1 to 10 fans and duties from 43 to 550 kW at 15 K temperature difference.

### Design

Finned coil with aluminium fins and 1/2" OD copper tubing

Tube centres: 38 x 38 mm  
Fin spacing: 2.25 mm

Casing and framework are of pregalvanised sheet steel (Sendzimir). Fanplate with fan discharge hood are of aluminium. The casing has an epoxy coating, light-grey (RAL 7035). Other colours are available as optional extra. All condensers are pressure tested at 25 bar, evacuated and provided with a dry nitrogen protection charge.

### Mounting

Standard mounting: vertical airflow. Horizontal airflow is possible.

For certain types horizontal airflow requires adaptation of refrigerant circuiting (see page 7) at an extra price.

Standard vertical airflow is supplied unless indicated differently in the order.

### Fans

4-blade corrosion resistant aluminium fan blades. Diameter 762 mm.

## Aircooled condensers

**LCY**

### Fanmotors

Fanmotors are of totally enclosed design, class IP-55.

#### Standard

n= 930 rpm

750 W, 220-240/380-415/50/3

Motors are wired to a common terminal box (one box per condenser coil), located at the endplate on the liquid header side of the coil.

For application at ambient temperatures above 40 °C, special motors on request.

Available at extra charge:

1: n= 690 rpm  
370 W, 220-240/380-415/50/3

2: n= 325 rpm  
120 W, 220-240/380-415/50/3

3: 2 speed motors 935/425 rpm  
750/150 W, 380-415/50/3

4: n= 930 rpm  
750 W, 220-240/50/1

5: single phase motor suitable for speed regulation with Thyristor speed controller.  
750 W max., 220-240/50/1

6: motor suitable for 60 Hz supply  
n= 840 rpm  
660 W, 220-254/380-440/60/3

### Corrosion protection

The condensers do have a high corrosion resistance through selected materials, surface treatment and construction. For application in aggressive surroundings (coastal- and industrial areas) following designs are available at an extra charge:

- fins of seawater resistant aluminium alloy (57S/5052).
- fins of prepainted aluminium (capacity reduction of 7% to be considered).
- copper fins.
- finned coils chromitized after assembling.

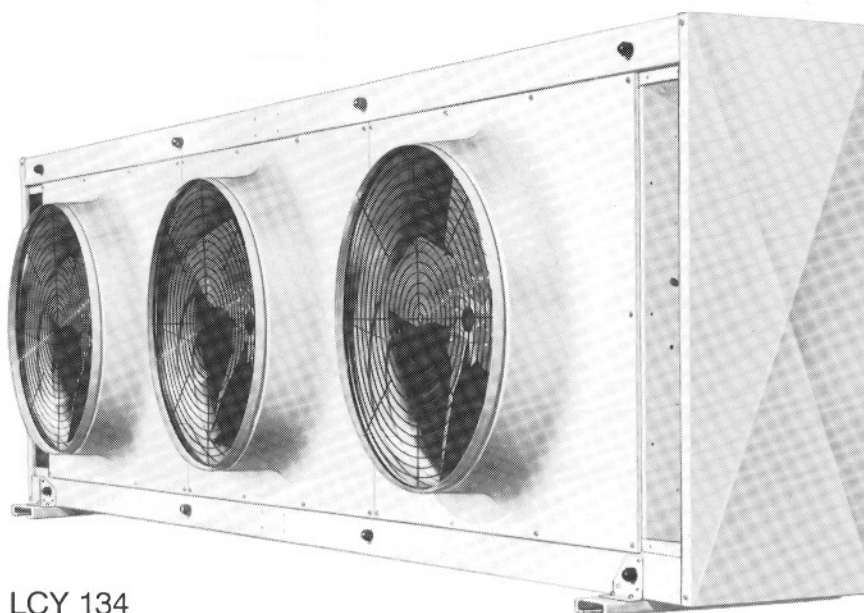

**LCY 134**

horizontal airflow

# Aircooled condensers

# LCY

## Capacities

## Soundlevels

Type	Capacity				Fans	airvolume m <sup>3</sup> /h, n= 930	Soundlevel dB(a)				Max. number of circuits available	
	td = 15 K*						number	n= 930	690	425		325
	kW											
LCY	n= 930	690	425	325								
LCY 113	43	36	29	25	1	15500	56	49	38	35	10	
LCY 114	53	43	33	27	1	15000	56	49	38	35	10	
LCY 123	90	76	58	50	2	31000	59	52	41	38	15	
LCY 124	108	89	65	54	2	30000	59	52	41	38	15	
LCY 133	137	118	89	79	3	46500	61	54	43	40	15	
LCY 134	158	133	98	81	3	45000	61	54	43	40	30	
LCY 143	180	154	115	100	4	62000	62	55	44	41	30	
LCY 144	216	180	133	108	4	60000	62	55	44	41	30	
LCY 154	275	230	168	135	5	75000	63	56	45	42	30	
LCY 223	180	154	115	100	4	62000	62	55	44	41	30	
LCY 224	216	180	133	108	4	60000	62	55	44	41	30	
LCY 233	274	236	178	158	6	93000	64	57	46	43	30	
LCY 234	316	266	196	162	6	90000	64	57	46	43	60	
LCY 243	360	308	230	199	8	124000	65	58	47	44	60	
LCY 244	432	360	266	216	8	120000	65	58	47	44	60	
LCY 254	550	460	336	270	10	150000	66	59	48	45	60	

### Capacity

The basic capacity ratings are for R22 and R502 at a td\* of 15 K and ambient temperatures up to 35 °C.

\*td = difference between condensing temperature and ambient temperature.

Capacities are directly proportional with other temperature differences between 10 and 20 K.

For correction-factors on capacity: see page 8.

### Capacity control

For multifan models capacity can be controlled by cycling one or more fans. Capacity control on all models is also possible by using 2-speed or speed regulated single phase motors. The fan compartments are separated by baffle plates.

### Soundlevel dB(a)

The soundlevels in the table are the results of tests carried out in free field conditions. The values are measured in the horizontal plane at a distance of 10 m around the condenser with an A-filter. Values may deviate depending on situations at site.

### Multi circuiting

Condensers can be supplied (at extra charge) with more separated coil sections.

### Applications as liquid cooler

The condenser can also be used as liquid cooler, for instance cooling back of cooling water in watercooled plants.

## Aircooled condensers

## LCY

### Technical data

Type	Refrigerant connections			Internal volume dm <sup>3</sup>	Cooling surface m <sup>2</sup>	Weight kg	
	mm ODS in	out				alu. fins	Cu fins
LCY 113	1 x 35	1 x 28	* **	16	135	158	248
LCY 114	1 x 35	1 x 28	**	22	179	178	298
LCY 123	1 x 42	1 x 35	**	32	269	276	456
LCY 124	1 x 42	1 x 35	**	42	359	316	556
LCY 133	1 x 54	1 x 42	**	48	404	394	664
LCY 134	1 x 54	1 x 42		63	538	454	814
LCY 143	1 x 67	1 x 54	*	64	538	518	878
LCY 144	1 x 67	1 x 54		84	717	598	1080
LCY 154	1 x 67	1 x 54		104	897	742	1340
LCY 223	2 x 42	2 x 35	**	64	538	552	912
LCY 224	2 x 42	2 x 35	**	84	717	632	1110
LCY 233	2 x 54	2 x 42	**	96	807	788	1330
LCY 234	2 x 54	2 x 42		126	1076	908	1630
LCY 243	2 x 67	2 x 54	*	128	1076	1030	1750
LCY 244	2 x 67	2 x 54		168	1434	1190	2150
LCY 245	2 x 67	2 x 54		208	1793	1470	2670

\* Type LCY 113, 143 and 243 do have the connections on both sides. The other types have the inlet- and outlet- connections at the same side.

\*\* Only suitable for horizontal airflow with special header arrangement.

### Type indication

f.i.: LCY 1 2 3

- 1- Number of coils \_\_\_\_\_
- 2- Number of fans per coil \_\_\_\_\_
- 3- Number of tuberows in airdirection \_\_\_\_\_

# Aircooled condensers

# LCY

## Factors for calculation of the condenser capacity

The condenser capacity is the compressor capacity multiplied with the factor from the diagram.

The diagrams are valid for R12, R22 and R502. At evaporating temperatures below -20 °C the condenser capacity has to be calculated from the compressor capacity at -20 °C, or a starting control should be used to protect the compressors from high starting loads.

### OPEN compressors

### SEMI-HERMETIC compressors (motor air/water cooled)

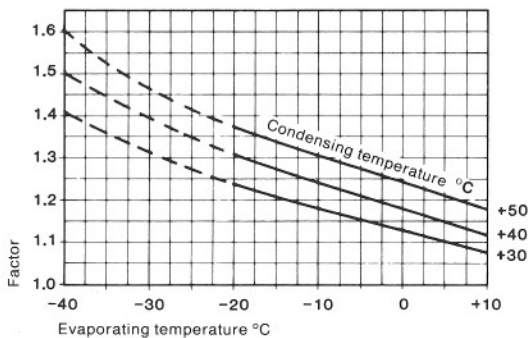

### SEMI-HERMETIC compressors (motor suctiongas cooled)

### HERMETIC compressors

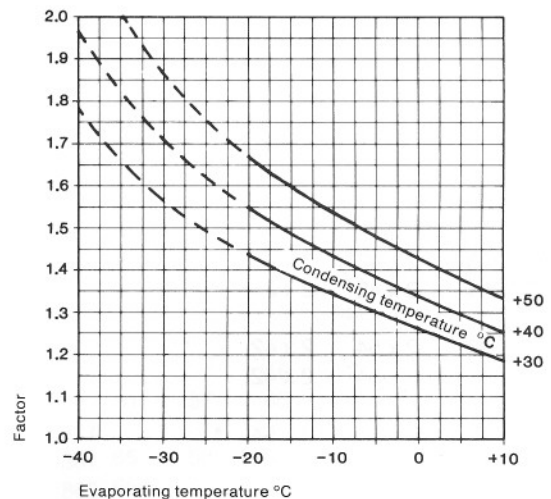

## Correction factors capacity

		Correction factor
Ambient temperature	35 °C	1.00
	40 °C	0.95
	50 °C	0.90
Altitude above sea level	0 m	1.00
	500 m	0.97
	1000 m	0.93
	1500 m	0.90
	2000 m	0.86
	2500 m	0.83
Refrigerant	R22/R502	1.00
	R12	0.95
Application of motors suitable for 60 Hz, n = 840 rpm		0.95

## Example

What capacity has a LCY 124 in an ambient temperature of 40 °C, refrigerant R12, altitude at sealevel and equipped with motors for 60 Hz:

Nominal capacity at td = 15 K: 108 kW

Correction factors:  
 t = 40 °C 0.95  
 R12 0.95  
 altitude 1.00  
 60 Hz motors 0.95

Corrected capacity:  
 0.95x0.95x1.00x0.95x108 = 92.5 kW



**Aircooled condensers**

**LCY**

Soundlevels dB(a)

Type	Distance 5 m				Distance 10 m				Distance 15 m				Distance 25 m							
	n=	930	690	425	325	n=	930	690	425	325	n=	930	690	425	325	n=	930	690	425	325
LCY 113		62	55	44	41		56	49	38	35		52	45	34	31		48	41	30	27
LCY 114		62	55	44	41		56	49	38	35		52	45	34	31		48	41	30	27
LCY 123		65	58	47	44		59	52	41	38		55	48	37	34		51	44	33	30
LCY 124		65	58	47	44		59	52	41	38		55	48	37	34		51	44	33	30
LCY 133		67	60	49	46		61	54	43	40		57	50	39	36		53	46	35	32
LCY 134		67	60	49	46		61	54	43	40		57	50	39	36		53	46	35	32
LCY 143		68	61	50	47		62	55	44	41		58	51	40	37		54	47	36	33
LCY 144		68	61	50	47		62	55	44	41		58	51	40	37		54	47	36	33
LCY 154		69	62	51	48		63	56	45	42		59	52	41	38		55	48	37	34
LCY 223		68	61	50	47		62	55	44	41		58	51	40	37		54	47	36	33
LCY 224		68	61	50	47		62	55	44	41		58	51	40	37		54	47	36	33
LCY 233		70	63	52	49		64	57	46	43		60	53	42	39		56	49	38	35
LCY 234		70	63	52	49		64	57	46	43		60	53	42	39		56	49	38	35
LCY 243		71	64	53	50		65	58	47	44		61	54	43	40		57	50	39	36
LCY 244		71	64	53	50		65	58	47	44		61	54	43	40		57	50	39	36
LCY 254		72	65	54	51		66	59	48	45		62	55	44	41		58	51	40	37

# Aircooled condensers

# LCY

## Vertical airflow

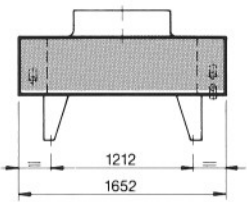

LCY 113/114

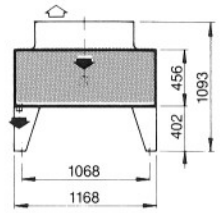

LCY range 1..

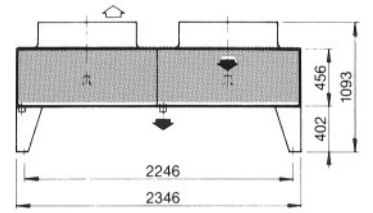

LCY range 2..

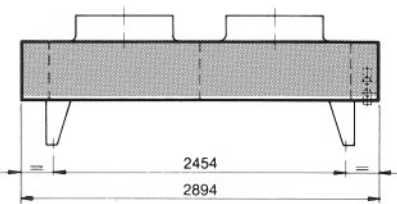

LCY 123/124      LCY 223/224

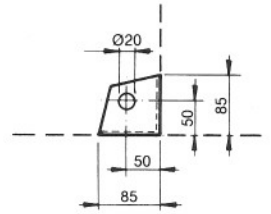

Bottom view mounting feet

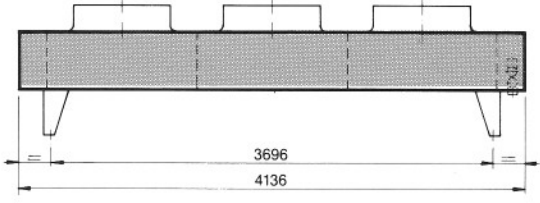

LCY 133/134      LCY 233/234

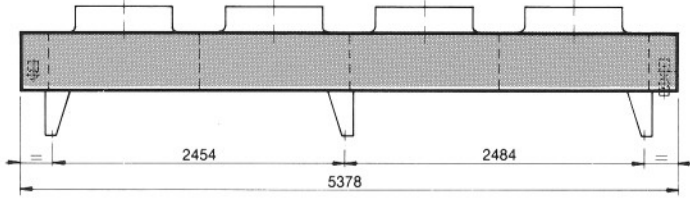

LCY 143/144      LCY 243/244

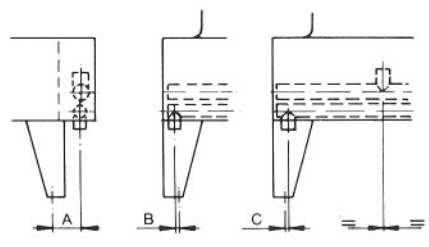

Liquid out	A	B	C
∅ 28	125	10	
35	125	5	
42	130	0	0
54	135		5

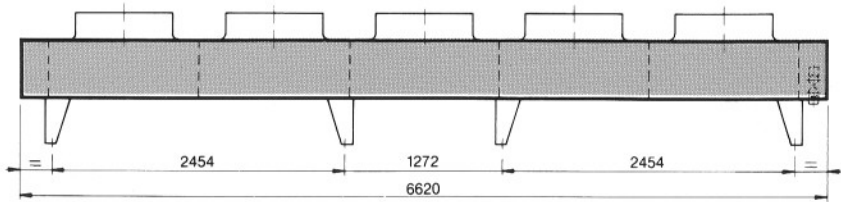

LCY 154      LCY 254

**Aircooled condensers**

**LCY**

Horizontal airflow

LCY range 1..

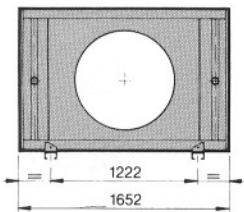

LCY 113/114

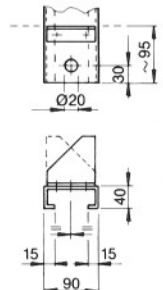
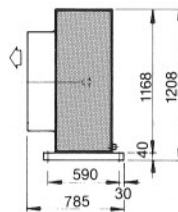

Mounting detail

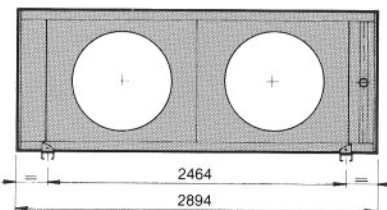

LCY 123/124

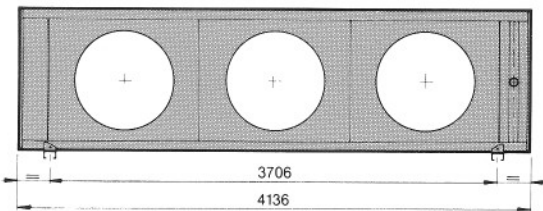

LCY 133/134

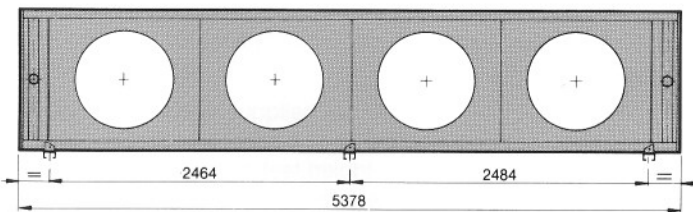

LCY 143/144

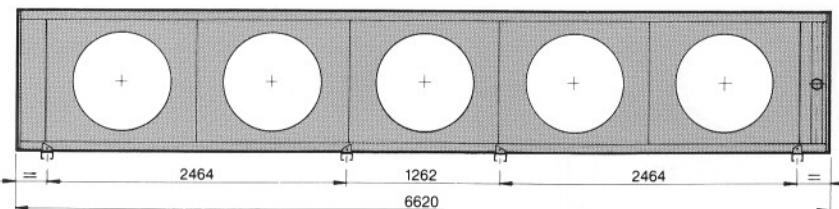

LCY 154

**Horizontal airflow**

Types LCY 113, 114, 123, 124 and 133, are only available for horizontal airflow on special delivery at extra price.

**Aircooled condensers**

**LCY**

Horizontal airflow

LCY range 2..

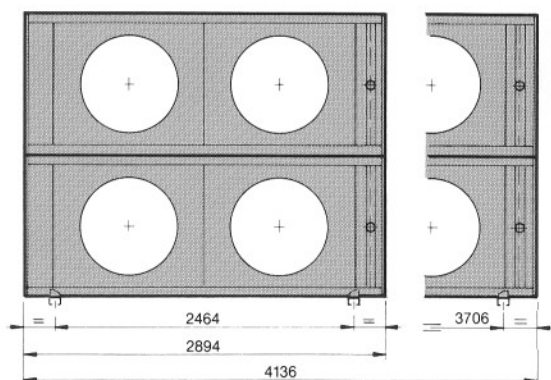

LCY 223/224

LCY 233/234

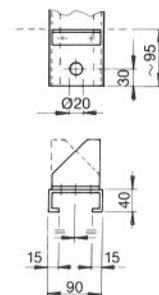

Mounting detail

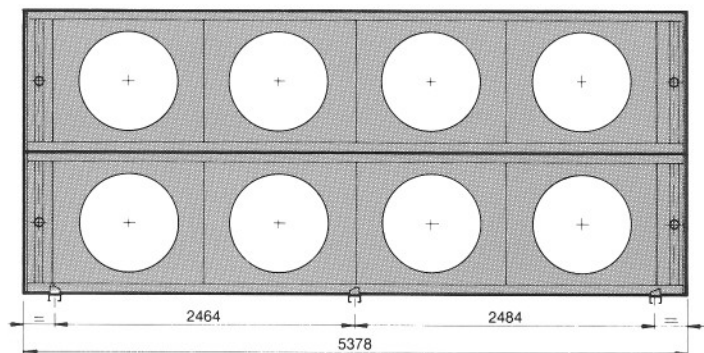

LCY 243/244

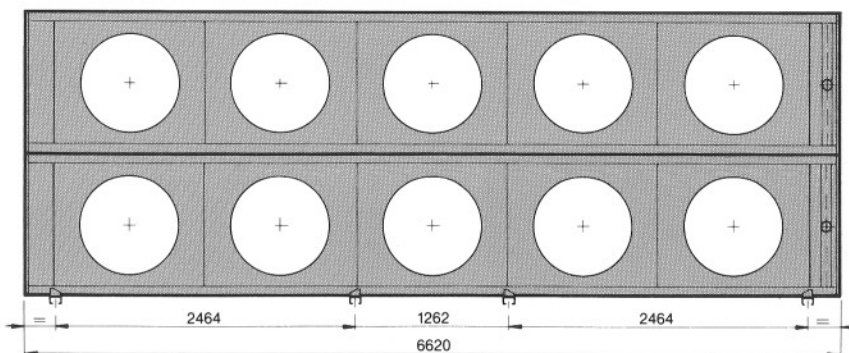

LCY 254

Horizontal airflow

Types LCY 223, 224 and 233, are only available for horizontal airflow on special delivery at extra price.

**Aircooled condensers**

**LCY**

**Coupling headers**

The condensers type LCY 223 - 254 are equipped with 2 finned coils, each having a pair of in- and outlet connections.

As optional extra coupling headers can be supplied. These coupling headers are supplied in loose parts having soldering connections.

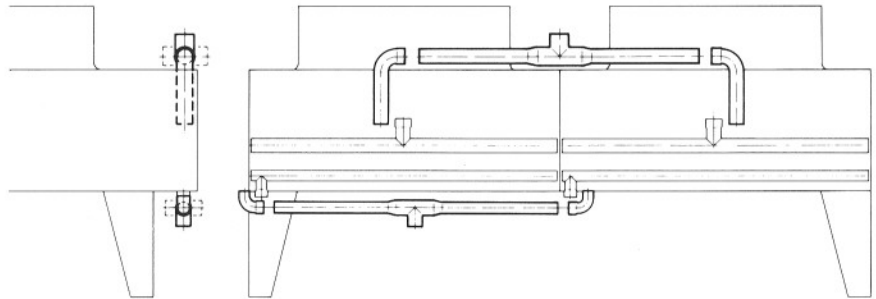

Type	Central connection mm	
	gas in	liquid out
LCY 223	54	42
LCY 224	54	42
LCY 233	67	54
LCY 234	67	54
LCY 243	80	67
LCY 244	80	67
LCY 254	80	67

**Extended feet**

Extended feet can be supplied as optional extra. These feet are supplied separately. The standard feet height leaves 402 mm free space under the condenser.

Extended feet are available for heights of 650, 900 and 1400 mm.

The 900 and 1400 mm feet do have truss beams.

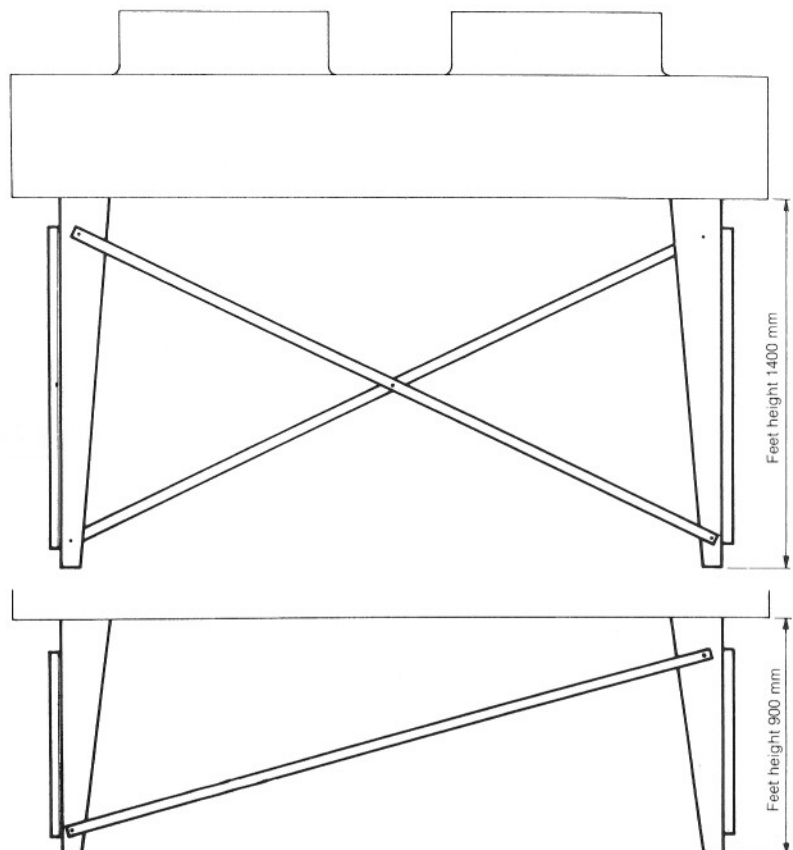

## Aircooled condensers

## LCY

### Transport

All types are provided with lifting lugs. To avoid damage during hoisting, a hoisting beam shall be used, by which the given angles are to be considered. Beware of shocks during transport and handling.

### Mounting

Refrigerant connections are to be soldered free of tension. When connecting more condensers in parallel the pressure drop on the refrigerant side has to be considered.

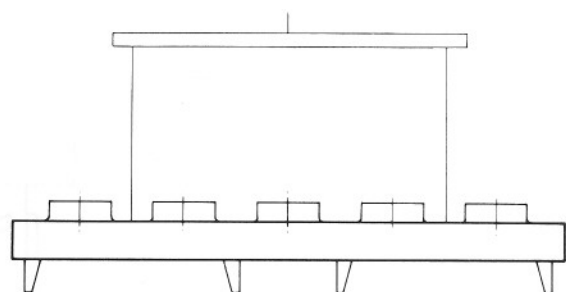
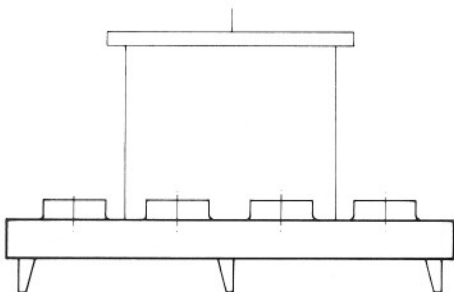
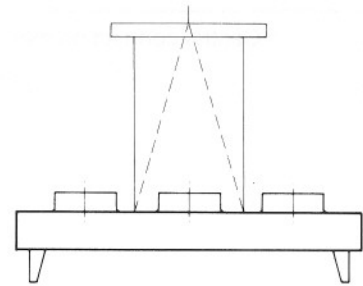
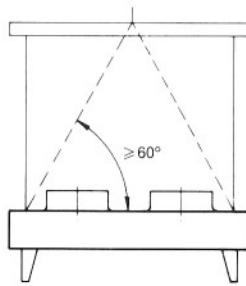
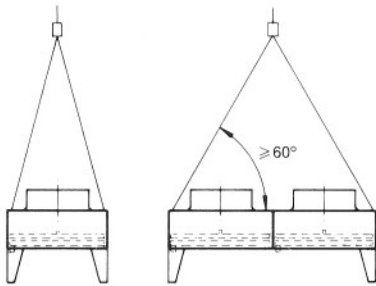

### Thermal overload relay settings

Motorspeed rpm	Duty Watt	Voltage Volt	Ampèrage Ampère
930	750	220-240/380-415/50/3	2.9 / 5
690	370	220-240/380-415/50/3	1.5 / 2.6
325	120	220-240/380-415/50/3	1.2 / 2
935/425	750/150	380-415/50/3	3.1 / 1.1
930	750	220-240/50/1	8
865 variable	750	220-240/50/1	8.4*
840	660	220-254/380-440/60/3	2.8 / 4.8

(ambient temperature -10 °C)

\*value at highest speed

**Apparatenfabriek Helpman N.V.**

Postbus 44  
9700 AA Groningen

Tel. (050) 26 26 15  
Fax (050) 26 48 78