



→ Water chillers  
Heat pump

“*Compact and silent*”

- Scroll compressors*
- High efficiency brazed-plate heat exchangers*
- All-aluminium micro-channel condenser*
- Self-adjusting electronic control*



Cooling capacity LD : 40 to 156 kW  
Cooling capacity ILD : 38 to 148 kW  
Heating capacity ILD : 42 to 150 kW



Cooling only



Cooling and heating



Hydraulic module



Heat recovery



## USE

The latest generation of **AQUACIAT** heat pumps and water chillers are the perfect solution for all heating and cooling applications in the Office, Healthcare, Industry, Administration, Shopping Centres and Collective Housing markets.

These units are designed for outdoor installation and require no special protection against adverse weather conditions.

AQUACIAT is optimised to use ozone-friendly HFC R410A refrigerant.

This range guarantees compliance with the most demanding requirements for increased seasonal energy efficiency (ESEER and SCOP) and CO2 reduction to comply with the various applicable European directives and regulations.

## RANGE

### AQUACIAT LD series

Cooling only version.

### AQUACIAT ILD series

Reversible heat pump version.

These two versions are optimised to meet the most demanding technical and economic requirements

## DESCRIPTION

AQUACIAT units are packaged machines supplied as standard with the following components:

- Hermetic SCROLL compressors
- Brazed-plate condenser or evaporator water type heat exchanger
- Air-cooled exchanger with axial fan motor assembly
  - all-aluminium micro-channel coil, cooling only version
  - copper tube coil with aluminium fins, reversible heat pump version
- Electrical power and remote control cabinet:
  - 400V-3ph-50Hz (+/-10%) general power supply + earth
  - transformer fitted as standard on the machine for supplying the remote control circuit with 24V
- Connect Touch electronic control module
- Casing for outdoor installation

The entire AQUACIAT range complies with the following EC directives and standards:

- Machinery directive 2006/42/EC
- Electromagnetic compatibility directive 2014/30/EU
- EMC immunity and emissions EN 61800-3 'C3'
- Low voltage directive 2014/35/EU
- RoHS 2011/65/EU
- Pressure equipment directive (PED) 2014/68/EU
- Machinery directive EN 60-204 -1
- Refrigerating systems and heat pumps EN 378-2

## DESCRIPTION

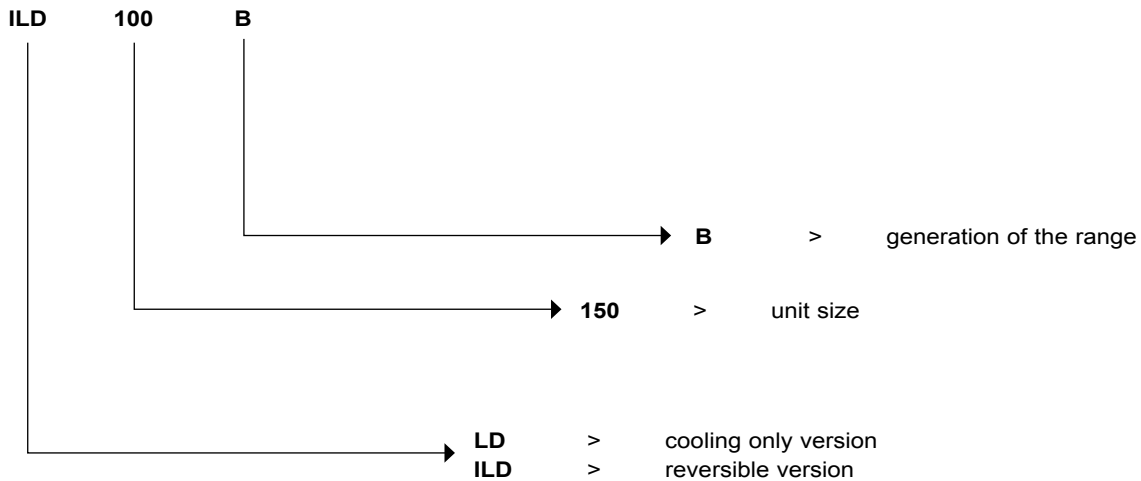

## CONFIGURATION

LD-ILD	Standard
LD-ILD, XLN option	Standard Xtra Low Noise

## DESCRIPTION OF THE MAIN COMPONENTS

### ■ Compressors

- Hermetic SCROLL type
- Electronic motor overheating protection
- Crankcase heater
- Mounted on anti-vibration mounts

### ■ Water type heat exchanger

- Brazed-plate exchanger
- Evaporator or condenser mode exchanger on the reversible heat pump version
- Plate patterns optimised for high efficiency
- 19 mm armaflex thermal insulation
- Frost protection provided by the heater

### ■ Air-cooled exchanger

- Air-cooled exchanger :
  - all-aluminium micro-channel coil, cooling only version
  - copper tube coil with aluminium fins, reversible heat pump version
- Condenser or evaporator mode exchanger on the reversible heat pump version
- axial fans with composite blades offering an optimised profile, fixed speed as standard or variable speed as an option
- motors – IP 54, class F

### ■ Refrigerating accessories

- Dehumidifier filters
- Hygroscopic sight glasses
- Electronic expansion valves
- Service valves on the liquid line
- 4-way cycle inversion valve in cooling/heating mode on the reversible heat pump version

### ■ Control and safety instruments

- Low and high pressure sensors
- Safety valves on refrigerating circuit
- Water temperature control sensors
- Evaporator antifreeze protection sensor
- Factory-fitted evaporator water flow rate controller

### ■ Electrical cabinet

- Electrical cabinet with IP 44 protection rating
- A connection point without neutral
- Front-mounted main safety switch with handle
- Control circuit transformer
- 24V control circuit
- Fan and compressor motor circuit breaker
- Fan and compressor motor contactors
- Connect Touch microprocessor-controlled electronic control module
- Wire numbering
- Marking of the main electrical components

### ■ Frame

Frame made from RAL7035 light grey & RAL 7024 graphite grey painted panels.

### ■ Connect Touch control module

- User interface with 4.3 inch touchscreen
- Intuitive, user-friendly navigation using icons
- Clear text display of information available in 5 languages (F-GB-D-E-I)



The electronic control module performs the following main functions:

- Regulation of the water temperature (at the return or at the outlet)
- Regulation of the water temperature based on the outdoor temperature (water law)
- Regulation for low temperature energy storage
- Second setpoint management
- Complete management of compressors with start-up sequence, timer and runtime balancing
- Self-adjusting and proactive functions with adjustment of drift control for parameters
- Optimised defrosting with free defrost function to optimise performance at partial load and the SCOP
- In-series staged power control system on the compressors according to the thermal requirements
- Management of compressor short-cycle protection
- Frost protection (exchanger heater)
- Phase reversal protection
- Management of occupied/unoccupied modes (according to the time schedule)
- Compressor and pump runtime balancing
- Management of the machine operation limit according to the outdoor temperature
- Sound level reduction device (night mode according to the user programme) with limitation of compressor capacity and fan speed
- Diagnosis of fault and operating statuses
- Management of a fault memory allowing a log of the last 50 incidents to be accessed, with operating readings taken when the fault occurs
- Master/slave management of the two machines in parallel with runtime balancing and automatic changeover if a fault occurs on one machine
- Weekly and hourly time schedule for the machine, including 16 periods of absence
- Pump standby based on demand (energy saving)
- Calculation of the water flow rate and operating pressure (hydraulic module version)
- Electronic adjustment of the water pump speed and water flow rate (variable speed pump option)
- Display of all machine parameters (3 access levels, User/Maintenance/Factory, password-protected): temperature, setpoints, pressures, water flow rate (hydraulic version), runtime.

## ■ Remote control

Connect Touch is equipped as standard with an RS485 port and an ETHERNET (IP) connection, offering a range of options for remote management, monitoring and diagnostics.

Using the integrated Webserver, a simple internet connection uses the unit's IP address to access the Connect Touch interface on the PC, facilitating everyday management tasks and maintenance operations.

A range of communication protocols are available: MODBUS/ JBUS RTU (RS485) or TC/IP as standard, LONWORKS – BACNET IP as an option, enabling most CMS/BMS to be integrated.

Several contacts are available as standard, enabling the machine to be controlled remotely by wired link:

- Automatic operation control: when this contact is open, the machine stops
- Heating/cooling mode selection
- Setpoint 1/setpoint 2 selector: when this contact is closed, a second cooling setpoint is activated (energy storage or unoccupied mode, for example)
- Power limitation: closing the contact concerned allows the power or refrigerating consumption of the machine to be limited by stopping one or more compressors (this limit can be set with a parameter)
- Fault reporting: this contact indicates the presence of a major fault which has caused one or both refrigerating circuits to stop
- Operational status reporting indicates that the unit is in production mode.
- Activation control for partial energy recovery using the desuperheater
- Switch control for the customer pump, external to the machine (on/off).

Contacts available as an option:

- Setpoint adjustable via 4-20 mA signal: this input is used to adjust the setpoint in COOLING mode
- On/off control for a boiler
- 4-stage on/off management for additional heaters.

## ■ Maintenance

Connect Touch has two maintenance reminder functions as standard, making users aware of the need to regularly perform maintenance operations and to guarantee the service life and performance of the unit. These two functions can be activated independently.

A reminder message appears on the unit's HMI screen, and stays there until it is acknowledged by the maintenance operator. The information and alert relating to these functions are available on the communication bus to be used on the CMS/BMS.

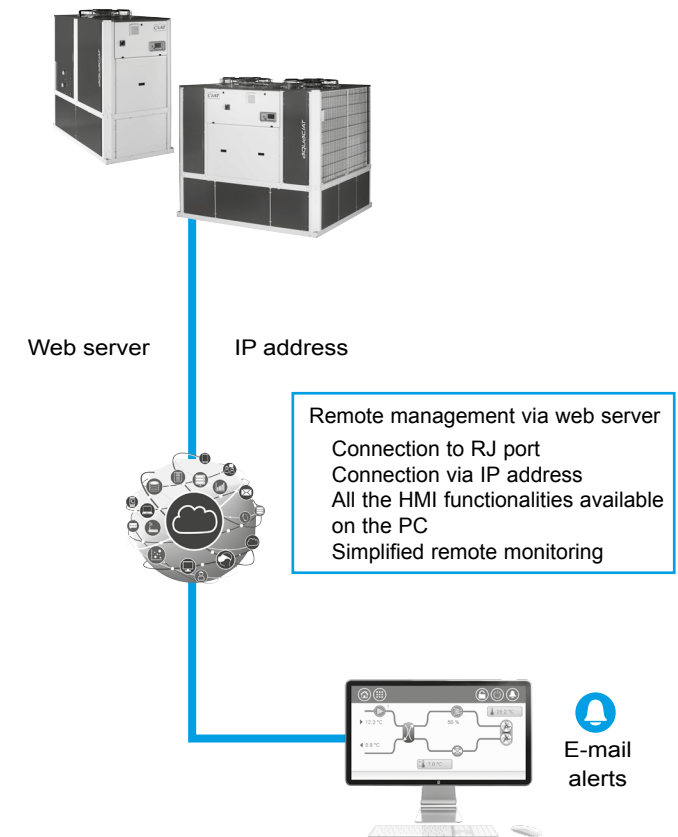

- the scheduled maintenance reminder: when activated, this function enables the period between two maintenance inspections to be set. This period may be set by the operator in either days, months or operating hours, depending on the application.
- the compulsory F-GAS sealing test maintenance reminder: when activated, this function, which is the default factory setting, enables the period between two sealing tests to be selected, according to the refrigerant charge, in compliance with the FGAS regulations

**■ CIATM2M, the CIAT supervision solution**

CIATM2M is a remote supervision solution dedicated to monitoring and controlling several CIAT machines in real time.

**Advantages**

- Access to the operating trend curves for analysis
- Improved energy performance
- Improved availability rate for the machines

**Functions**

CIATM2M will send data in real time to the supervision website, [www.ciatm2m.com](http://www.ciatm2m.com).

The machine operating data can be accessed from any PC, smartphone or tablet.

Any event can be configured to trigger a mail alert.

Parameters monitored:

- Overview
- Control panel for the controllers
- Events
- Temperature curves

Monthly and annual reports are available to analyse:

- The performance and operation of the machine  
Example: operating curves and time, number of compressor start-ups, events, preventive maintenance actions to be performed, etc.
- The electricity consumed (if the energy meter option is present)

Incidents such as a drift in the measurements on a temperature sensor, incorrectly set control parameters, or even incorrect settings between one compressor stage and the other are immediately detected, and the corrective actions put in place.

**Equipment**

This kit can be used on both machines which are already in use (existing inventory), and on new machines which do not have sufficient space in their electrical cabinets.

- 1 transportable cabinet
- 1 wall-mounted antenna

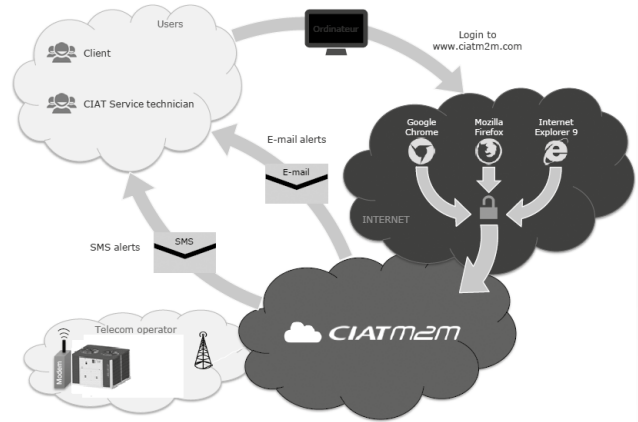

**CIATM2M kit contents**

- 1 GPRS / 3G modem
- 1 SIM card
- 1 24VDC power supply
- 1 power protection device
- 1 GSM antenna
- Rail mounting
- Enclosed casing to protect the equipment during transport
- Packing box for cable routing (bus, power supply, Ethernet)

**Compatibility**

Up to 3 machines per CIATM2M kit

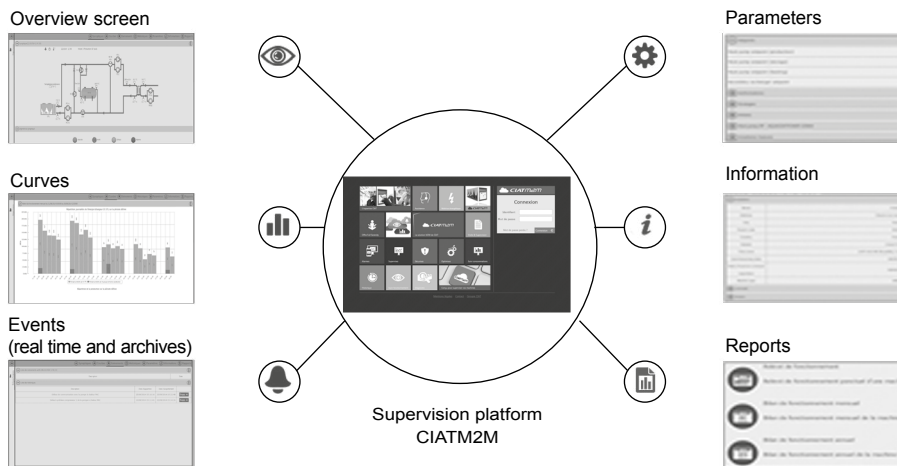

## AVAILABLE OPTIONS

Options	Description	Advantages	LD	ILD
Condenser with anti-corrosion post-treatment	Copper/aluminium coils supplied with Blygold Polual treatment applied	Improved corrosion resistance, recommended for industrial, rural and marine environments	▲	no
Corrosion protection, traditional coils	Fins made of pre-treated aluminium (polyurethane and epoxy)	Improved corrosion resistance, recommended for moderate marine and urban environments	▲	●
Medium-temperature brine solution	Production of chilled water at low temperatures (down to 0°C) with ethylene glycol and propylene glycol.	Covers specific applications such as ice storage and industrial processes	●	●
Low-temperature brine solution	Production of chilled water at low temperatures (down to -15°C with ethylene glycol and -12°C with propylene glycol).	Covers specific applications such as ice storage and industrial processes	●	●
Xtra Fan	Unit equipped with special variable speed fans: Xtra Fan (see dedicated section for the maximum available pressure according to the size), with each fan equipped with a connection flange and sleeves for connection to the duct system.	Ducted fan discharge, optimised condensing temperature control (or evaporating temperature control on the heat pump version), based on the operating conditions and system characteristics	●	●
Xtra Low Noise	Sound absorbing enclosure for the compressor and low speed fans	Reduces the noise level by reducing the fan speeds	●	●
Protective grilles	Metal protective grilles	Protects the coils against any impacts	●	no (*)
Soft Starter	Electronic starter on each compressor	Reduces the start-up current	●	●
Winter operation (down to -20°C)	Controls the fan speed	Stable operation of the unit when the air temperature is between 0°C and -20°C.	●	●
Antifreeze protection down to -20°C	Electric heater on the hydraulic module	Frost protection of the hydraulic module at low outdoor temperatures	●	●
Water heat exchanger and hydraulic module frost protection	Trace heaters on the water heat exchanger, water pipes, hydraulic module, expansion vessel and buffer tank module	Frost protection of the water type heat exchanger and hydraulic module down to an outdoor air temperature of -20°C	●	●
Partial heat recovery	Unit equipped with a desuperheater on each refrigerating circuit	Simultaneous free production of hot water (high temperature) and production of chilled water (or hot water for the heat pump)	●	●
Master/slave operation	Unit equipped with an additional water outlet temperature sensor, to be installed on site, enabling Master/Slave operation of 2 units connected in parallel	Optimised operation of two units connected in parallel with run time equalisation	●	●
HP single-pump hydraulic module	Single high-pressure water pump, water filter, electronic water flow control, pressure transducers. For more details, refer to the dedicated section (expansion tank not included. Option with integrated hydraulic safety components available.)	Quick, easy installation (plug & play)	●	●
HP dual-pump hydraulic module	Dual high-pressure water pump, water filter, electronic water flow control, pressure sensors. For more details, refer to the dedicated section (expansion tank not included. Option with integrated hydraulic safety components available.)	Quick, easy installation (plug & play)	●	●
LP single-pump hydraulic module	Single low-pressure water pump, water filter, electronic water flow control, pressure sensors. For more details, refer to the dedicated section (expansion tank not included. Option with integrated hydraulic safety components available.)	Quick, easy installation (plug & play)	●	●
LP dual-pump hydraulic module	Dual low-pressure water pump, water filter, electronic water flow control, pressure sensors. For more details, refer to the dedicated section (expansion tank not included. Option with integrated hydraulic safety components available.)	Quick, easy installation (plug & play)	●	●
HP single variable-speed pump hydraulic module	Single high pressure water pump with variable speed drive, water filter, electronic water flow rate control, pressure sensors. Multiple water flow control options. For more details, refer to the dedicated section (expansion tank not included. Option with integrated hydraulic safety components available.)	Quick, easy installation (plug & play), significant reduction in energy consumption for pump use (more than two-thirds), tighter water flow control, improved system reliability	●	●
HP variable speed dual pump hydraulic module	Dual high pressure water pump with variable speed drive, water filter, electronic water flow rate control, pressure sensors. Multiple water flow control options. For more details, refer to the dedicated section (expansion tank not included. Option with integrated hydraulic safety components available.)	Quick, easy installation (plug & play), significant reduction in energy consumption for pump use (more than two-thirds), tighter water flow control, improved system reliability	●	●
HP variable speed dual pump hydraulic module	Dual high pressure water pump with variable speed drive, water filter, electronic water flow rate control, pressure sensors. Multiple water flow control options. For more details, refer to the dedicated section (expansion tank not included. Option with integrated hydraulic safety components available.)	Quick, easy installation (plug & play), significant reduction in energy consumption for pump use (more than two-thirds), tighter water flow control, improved system reliability	●	●

● ALL MODELS

▲ ALL MODELS with desuperheater or low and very low temperature glycol/water mix option

(\*) Standard equipment on ILD version

Refer to the selection tool to find out which options are not compatible.



Options	Description	Advantages	LD	ILD
LON communication gateway	Two-directional communication board complying with Lon Talk protocol	Connects the unit by communication bus to a building management system	●	●
BACnet/IP	Two-directional high-speed communication using BACnet protocol over Ethernet network (IP)	Easy and high-speed connection by Ethernet line to a building management system. Allows access to multiple unit parameters	●	●
External management of the boiler	Control board factory installed on the unit for controlling a boiler	"Expands the remote control capacities to include a boiler on/off control. Facilitates control of a basic heating system"	no	●
Management of electric heaters	Control board factory-fitted on the unit with additional inputs/ outputs enabling up to 4 external heating stages to be managed (electric heaters.etc.)	Expands the remote control capacities to include a maximum of four electric heaters. Facilitates control of a basic heating system	no	●
Compliance with Russian regulations	EAC certification	Compliance with Russian regulations	●	●
Protect2 anti-corrosion protection for micro-channel coils	Coating which uses a conversion process to alter the aluminium surface into a coating which forms an integral part of the coil. Complete immersion in a bath to ensure 100% coverage. No thermal transfer variation, tested to withstand more than 4000 hours of salt spray as per ASTM B117	Protect2 coating which doubles the corrosion resistance offered by micro-channel coils, recommended for use in moderately corrosive environments	●	no
Protect4 anti-corrosion protection for micro-channel coils	Flexible, durable polyepoxide coating applied using an electroplating process to give micro-channel coils an anti-UV top layer. Minimal variation in the thermal transfer, tested to withstand more than 6000 hours of constant neutral salt spray as per ASTM B117, improved impact resistance as per ASTM D2794	Protect4 coating gives a fourfold increase in the corrosion resistance offered by micro-channel coils, recommended for use in corrosive environments	●	no
Water heat exchanger connection sleeves, screw connection	Water heat exchanger inlet/outlet connection sleeves, screw connection	Allows unit connection to a screw connector	●	●
Reinforced filtration of the fan frequency inverter	Fan frequency inverter compliant with IEC 61800-3 class C1	Allows the unit to be installed in a residential environment, by reducing electromagnetic disturbance	no	● with variable speed fan option
Reinforced filtration of the pump frequency inverter	Pump frequency inverter compliant with IEC 61800-3 class C1	Allows the unit to be installed in a residential environment, by reducing electromagnetic disturbance	● with variable speed pump option	● with variable speed pump option
Expansion vessel	6-bar expansion vessel integrated into the hydraulic module (requires option 116)	Easy, quick installation (ready to use), and closed circuit protection of hydraulic systems to counter excessive pressure	●	●
Buffer tank module	Integrated buffer tank module	Prevents compressor short cycling and provides stability of the water in the loop	●	●
Anti-vibration mounts	Elastomer anti-vibration mounts to be fitted underneath the unit	Isolates the unit from the building, preventing vibrations and noise from being transmission to the building. Must be used in conjunction with a flexible connection on the water side	●	●
Flexible connection couplings for the exchanger	Flexible connections for the water type heat exchanger	Easy to install. Limits the transmission of vibrations to the water network	●	●
Desuperheater flexibles connection (kit)	Flexibles connections on the desuperheater water side	Easy installation. Limit transmission of vibrations on the water network	●	●
Water filter on the evaporator	Water filter	Prevents fouling in the water network	● no pump	● no pump
Setpoint adjustable via 4-20 mA signal	Connections enabling a 4-20 mA signal input	Simplified energy management, enabling the setpoint to be set by a 4-20 mA external signal	●	●
Free cooling mode drycooler management	Control and connections for an Opera or Vextra drycooler in free cooling mode equipped with the FC optional control unit	Simplified system management, increased control capacities to enable the drycooler to be used in free cooling mode	●	no
Evap. single pump power/ control circuit	Unit equipped with an electrical power and control circuit for one pump evaporator side	Quick and easy installation: the control of fixed speed pumps is embedded in the unit control	●	●
Evap. dual pumps power/ control circuit	Unit equipped with an electrical power and control circuit for two pumps evaporator side	Quick and easy installation: the control of fixed speed pumps is embedded in the unit control	●	●
M2M supervision (accessory)	Monitoring solution which allows customers to track and monitor their equipment remotely in real time	Real-time expert technical support to improve equipment availability and reports at customer hand to monitor and optimize operating equipment.	●	●

● ALL MODELS

Refer to the selection tool to find out which options are not compatible.

## SEASONAL PERFORMANCE, COOLING MODE

Most central air conditioning systems installed in the tertiary sector in Europe use water chillers to provide refrigeration.

Analyses of installed systems show that the heat load varies from season to season, and that a water chiller operates at reduced capacity for the majority of the time.

The European Seasonal Energy Efficiency Ratio (ESEER) measures the seasonal efficiency of water chillers by taking into account their efficiency under partial load using formulas created by the European certification body Eurovent.

### ■ Seasonal heat load variations

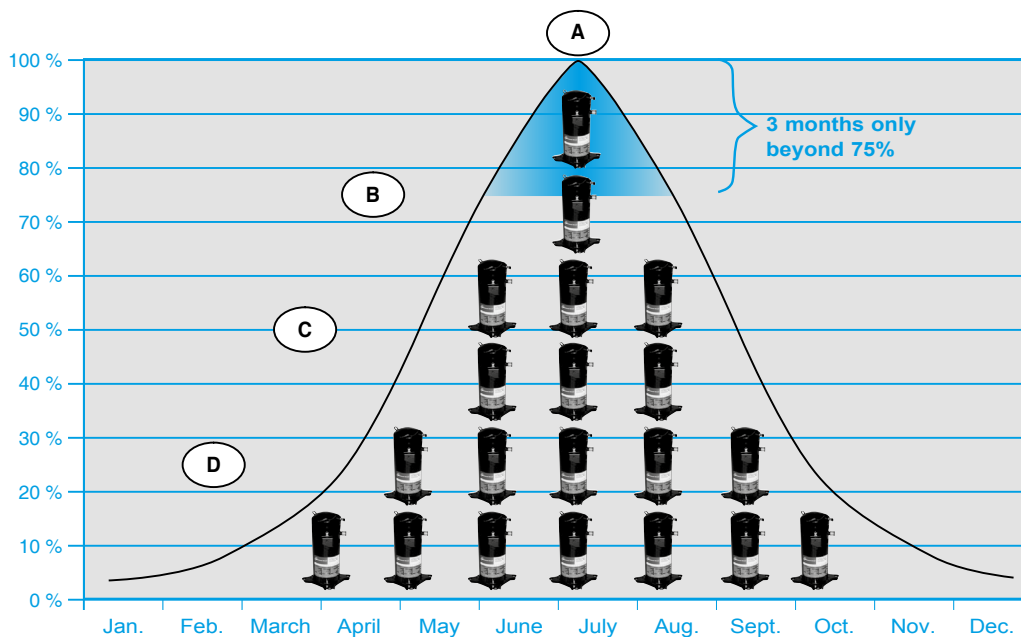

$$ESEER = A \times EER_{100\%} + B \times EER_{75\%} + C \times EER_{50\%} + D \times EER_{25\%}$$

A, B, C and D are weighting coefficients pertaining to a unit's running time based on its load  
The ESEER design conditions for air-cooled water chillers are as follows:

Load (%)	Air temperature (°C)	Chilled water (°C)	Energy efficiency	Weighting coefficient
100	35	12 / 7	EER100%	A = 0.03
75	30	-17 (*)	EER75%	B = 0.33
50	25	-17 (*)	EER50%	C = 0.41
25	20	-17 (*)	EER25%	D = 0.23

(\*) Water flow rate = Water flow rate at 100%

The efficiency under partial load is therefore essential when choosing a water chiller. It is with this in mind that the new AQUACIAT range was designed. In particular, the entire range uses R410A refrigerant which, thanks to its thermodynamic performance, makes it possible to obtain much higher ESEER ratings.

As the compressors are connected in parallel on the refrigerating circuit, the AQUACIAT easily and efficiently adjusts the cooling capacity to the system's needs. The self-adjusting Connect Touch control anticipates variations in load and starts only the number of compressors needed. This ensures optimum operation of the compressors and guarantees energy efficiency for the majority of the system's life.

As an option, the AQUACIAT can be equipped with variable speed fan motors. This technology enables the machine's performance at partial loads to be improved, along with its ESEER.



## SEASONAL PERFORMANCES IN HEATING MODE

The European Ecodesign directive takes into account the product's environmental impact throughout its life cycle. It defines the mandatory energy efficiency requirements for water chillers and heat pumps.

Products that do not meet the energy efficiency requirements set by the new directive will gradually be phased out of the market, forcing manufacturers to develop and offer more efficient products.

Like the ESEER relating to water chillers, the new seasonal coefficient of performance (SCOP) resulting from this new European directive is used to evaluate the energy efficiency of heat pumps. Until now, only the COP has been used to measure energy efficiency in heating mode.

The COP was exclusively calculated using a single measuring point, and only took into account operation at full load, which did not represent the efficiency of the heat pump over an entire heating season.

The purpose of the SCOP is to characterise the seasonal efficiency of the heat pump by taking into account the efficiency at partial load and full load established for several outdoor temperatures. The SCOP is the ratio between the building's annual heating demand and the annual electricity consumption of the heating system. It is measured in accordance with the EN14825 standard based on an average reference climate that takes into account several reference temperatures between -10°C and +16°C

### ■ Primary energy evaluation

In order to compare the energy efficiency of products using different energy sources, the Ecodesign directive introduced a new seasonal energy efficiency calculation known as  $\eta_s$  (Greek letter eta followed by the letter "s" for seasonal) and expressed as a percentage. For heat pumps, the SCOP (final energy) value is transposed to  $\eta_s$  (primary energy) by taking into account a conversion coefficient of 2.5 which corresponds to the average efficiency of the electrical production and various corrections for the responsiveness of the regulation system ( $i = 3$  for air-to-water heat pumps).

$$\eta_s (\%) = \frac{(\text{SCOP}(\text{kW}/\text{kW}) \times 100)}{2.5} - \sum_i \text{corrections}$$

The minimum seasonal efficiency requirements to be met by low temperature heat pumps, set by the standard, are as follows:

**$\eta_s = 115\%$ , which is a minimum SCOP of 2.95 valid from September 2015.**

AQUACIAT complies with the European Ecodesign 2015 directive, offering SCOP of between 2.96 and 3.23 across the entire range.

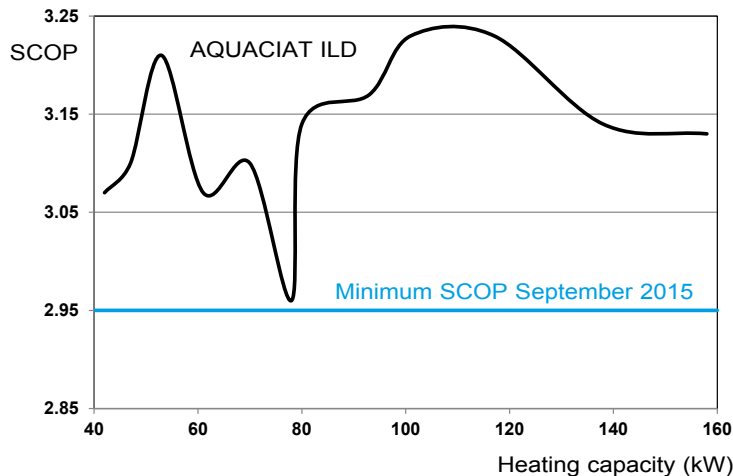

## HYDRAULIC MODULE

### ■ The "ALL-IN-ONE" solution

#### The PLUG & COOL solution offered by AQUACIAT

The hydraulic module contains all the water circuit components needed for the system to operate correctly:

- Buffer tank with 19mm insulation, 250-litre capacity (option).
- Expansion vessel (option):
  - 12 litres, 18 litres or 35 litres, depending on the model (see table of technical specifications)
- Wide selection of pumps:
  - Single or dual pumps with runtime balancing and backup.
  - High or low pressure pumps.
  - Fixed-speed or variable-speed pumps.
- Water temperature and pressure sensors.
- Water filter
- Relief valve
- Drain circuit
- Air bleed valve
- Frost protection (option)

The components in the hydraulic system are carefully

selected and factory assembled and tested to make the installation of the units simple and economical.

This ensures conditioning times, implementation times and space requirements are kept to a minimum.

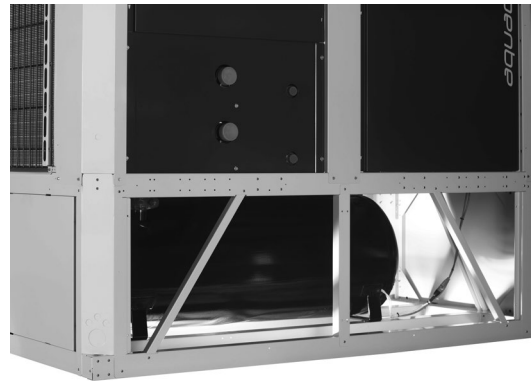

### ■ AQUACIAT hydraulic module diagram

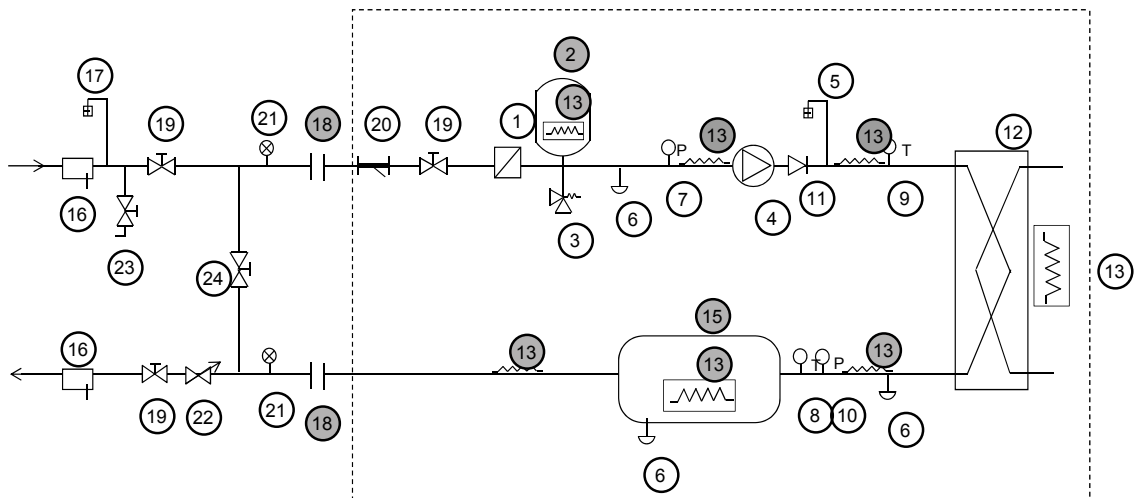

#### Key

##### Components of the unit and hydraulic module

- 1 Screen filter (particle size of 1.2 mm)
- 2 Expansion vessel
- 3 Relief valve
- 4 Circulating pump (single or dual)
- 5 Air bleed valve
- 6 Water drain tap
- 7 Pressure sensor
- Notes:
  - Provides information on the pump inlet pressure 8 Temperature sensor
  - Provides information on the water type heat exchanger outlet temperature 9 Temperature sensor
  - Provides information on the water type heat exchanger inlet temperature 10 Pressure sensor
  - Provides information on the water type heat exchanger outlet pressure 11 Check valve (for dual pumps)
  - 12 Plate heat exchanger
  - 13 Heater or heat trace cable for antifreeze protection
  - 14 Water type heat exchanger flow rate sensor
  - 15 Buffer tank module
  - Option

##### System components

- 16 Pocket
- 17 Air bleed valve
- 18 Flexible connection
- 19 Shut-off valve
- 20 800 µm screen filter (Option - mandatory in the case of a unit without hydraulic module/included on version with hydraulic module)
- 21 Pressure gauge
- 22 Water flow rate control valve
- Note: not required if hydraulic module with variable speed pump
- 23 Charge valve
- 24 Bypass valve for frost protection (if shut-off valves are closed (item 19) during winter)
- - - - Hydraulic module (unit with hydraulic module option)
- Notes:
  - The system must be protected against frost.
  - The unit's hydraulic module and the water type heat exchanger may be protected against freezing (factory-fitted option) using electric heaters and heat trace cables (13)
  - The pressure sensors are fitted on connections without Schraeder. Depressurise and empty the system before replacement.

## VARIABLE FLOW PUMP

### ■ Description

The AQUACIAT may be equipped with one or two variable speed pumps which save you energy by adjusting the electrical consumption of one pump to the actual requirements of a hydraulic system, in particular for oversized installations.

### ■ Simple to use

The "variable speed pump" is fully integrated on the machine, with full protection, and, as it is installed outdoors, there is no need for any work in the machine room.

The assembly is factory-fitted and pre-set on the unit; it is therefore quick to install and reduces the cost of work, in particular because there is no water flow control valve on the unit's outlet.

The ability to adjust the water flow to your requirements means that the pump pressure can be adapted precisely to the actual pressure drop on the system when it is started up on-site.

### ■ Operating principle

#### - Operation at full load

A regulator, with a direct display of the flow rate and pressure on the Connect Touch screen, enables one pump (pump A in the example below) to be adapted, by lowering its pressure P1 to the requirements of system P2, to obtain the optimal water flow rate setpoint. Electricity bills relating to the pump's consumption are reduced proportionately; this means you will see a return on investment (ROI) in only a few years, compared with the same fixed speed pump equipped with a simple flow control valve.

#### - Operation at partial load

There are three operating modes for partial load:

##### ● Fixed speed

The control ensures the pump continuously runs at a constant speed, based on the capacity of the compressor(s). When the compressor is powered off, the Connect Touch "standby" function manages the electrical power consumed by the pump by reducing its speed to the minimum.

**This provides energy savings of around 33%**

##### ● Variable flow rate: Constant regulation of the pressure difference

The control continuously acts on the pump speed to ensure a constant pressure difference (delta P). This solution is suitable for installations with two-way valves. This control mode is used to ensure a uniform supply in each hydraulic circuit to make sure that each terminal unit operates at a satisfactory pressure

##### ● Variable flow rate: Constant regulation of the temperature difference

The control maintains a constant temperature difference, regardless of the unit's load rate, by reducing the flow rate to within the minimum acceptable limit. This control mode is suitable for most comfort applications.

**This provides energy savings of around 66% for the pump in each of these last two operating modes**

### ■ SOFT START

A SOFT START function prevents any current peaks when the pump is started up to protect the electrical system, thereby limiting the building's electricity use at peak times and ensuring the smooth operation of the pipework.

### ■ STANDBY function

Lowering the speed when the compressors are on standby reduces the water flow rate to ensure the water loop is perfectly homogenised and the control temperature sensors are well irrigated. This reduces the pump's electricity consumption by around 80% during standby periods, which represents a significant proportion of the machine's normal operating time, in particular for air conditioning applications.

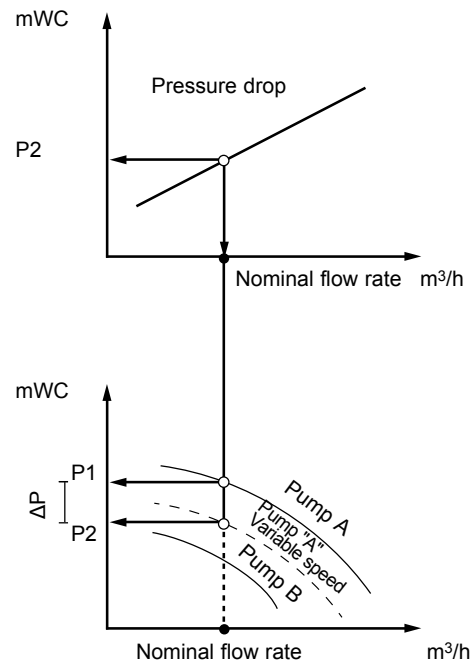

## ENVIRONMENTAL RESPONSIBILITY

The AQUACIAT contributes to sustainable development via an environmentally responsible approach, aimed at balancing ecological and economic concerns. This enables it to meet the requirements of future European thermal regulations and to protect our environment for future generations.

The highly efficient performance it offers enables energy consumption to be greatly reduced, thereby reducing the unit's carbon footprint throughout its service life.

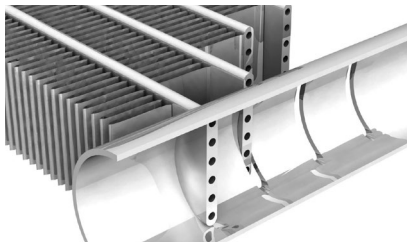

This performance is the result of the high quality components used, which have all been rigorously selected:

- The latest generation Scroll compressors
- Highly efficient R410A refrigerant, which has a low environmental impact: zero ODP (Ozone Depletion Potential), low GWP (Global Warming Potential)
- MCHE micro-channel type coils for the cooling only version:
  - Energy efficiency increased by 10% compared to a conventional coil
  - 40% reduction in the refrigerant charge.
  - Reduction in the unit weight, reducing the environmental impact during transportation
  - Simplified end of life recycling thanks to the all-aluminium construction
- Asymmetrical PBHE brazed-plate heat exchangers
  - Reduction in the refrigerant charge compared with a tubular heat exchanger solution
  - The asymmetrical technology enables a reduction in pressure drops on the water side, and an associated drop in electricity consumption.

AQUACIAT		150	180	200	240	260	300	360	390	450	520	600
Refrigerant load	kg	4.7	5.3	5.9	6.7	6.2	7.3	10.7	10.8	11.4	13	14.8
Environmental impact	tCO <sub>2</sub> eq	9.8	11.1	12.3	14	12.9	15.2	22.3	22.6	23.8	27.2	31

Only 20% of a unit's impact on the ozone layer comes from the refrigerant (direct effect), with 80% coming from the CO<sub>2</sub> released into the atmosphere when the electricity required to power the unit is produced (indirect effect). With AQUACIAT, it's a win-win situation: its low refrigerant charge minimises the risk of emissions, and its low energy consumption limits its indirect impact.

The choice of technology used in the AQUACIAT range means that the TEWI, which covers the unit's environmental impact (both direct and indirect) throughout its service life, is greatly reduced.

## INTEGRATION INTO THE MOST DEMANDING ENVIRONMENTS

The AQUACIAT has standard or optional equipment which enables it to be integrated into any one of a diverse range of environments.

In the micro-channel (MCHE) coil, the rate of corrosion is less than in a conventional coil with copper tube and aluminium fins. Indeed, its all-aluminium design limits the galvanic couples in the coil, thereby providing increased corrosion resistance

- The Protect2 anti-corrosion post-treatment option doubles its resistance to corrosion. This treatment is applied by immersing the coil, ensuring complete protection as the aluminium surface undergoes a chemical change.

This treatment is recommended for moderately corrosive environments

- The Protect4 anti-corrosion post-treatment option provides a fourfold increase in resistance to corrosion. An e-coating process is used to electro-coat the coil in polymer epoxy, and then a top layer of anti-UV protection is applied.

This treatment is recommended for highly corrosive industrial and marine environments

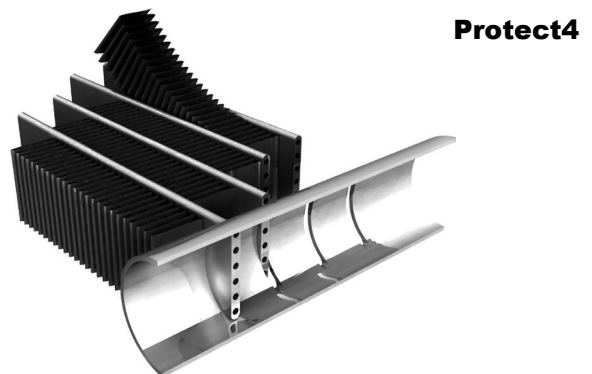
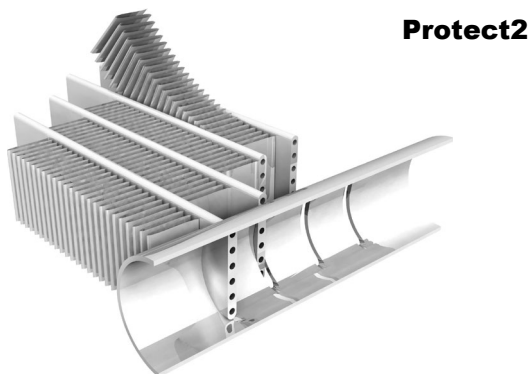

## TECHNICAL CHARACTERISTICS - COOLING ONLY



AQUACIAT LD				150	180	200	240	260	300	360	390	450	520	600
Cooling														
Standard unit	C1	Nominal capacity	kW	40	44	51	58	67	79	87	97	114	135	156
Full load performances*	C1	EER	kW/kW	2.87	2.76	2.67	2.66	2.72	2.70	2.73	2.73	2.67	2.70	2.65
	C2	Nominal capacity	kW	53	59	69	81	85	98	114	126	151	171	194
	C2	EER	kW/kW	3.44	3.32	3.12	3.31	2.97	3.06	3.18	3.09	3.10	2.99	3.01
Seasonal efficiency*	C1	ESEER	kW/kW	3.75	3.88	3.95	3.80	3.62	3.67	3.91	3.94	3.83	3.68	3.87
Part Load integrated values		IPLV.SI	kW/kW	4.54	4.71	4.81	4.58	4.26	4.39	4.55	4.53	4.55	4.29	4.64
<b>Sound levels</b>														
<b>Standard unit</b>														
Sound power <sup>(1)</sup>		dB(A)		80	81	81	81	87	87	84	84	84	90	90
Sound pressure at 10 m <sup>(2)</sup>		dB(A)		49	49	49	49	55	55	52	52	52	58	58
<b>Unit + Xtra Low Noise option</b>														
Sound power <sup>(1)</sup>		dB(A)		79	80	80	80	80	80	83	83	83	83	83
Sound pressure at 10 m <sup>(2)</sup>		dB(A)		48	48	48	48	48	48	51	51	51	51	51
<b>Dimensions</b>														
Length		mm		1090	1090	1090	1090	1090	1090	2270	2270	2270	2270	2270
Width		mm		2109	2109	2109	2109	2109	2109	2123	2123	2123	2123	2123
Height		mm		1440	1440	1440	1440	1440	1440	1440	1440	1440	1440	1440
Height with Buffer Tank Module		mm		2040	2040	2040	2040	2040	2040	2040	2040	2040	2040	2040
<b>Operating weight with micro-channel coils<sup>(3)</sup></b>														
Standard unit		kg		422	430	436	449	445	463	753	762	771	829	854
Unit + High pressure single pump option		kg		463	472	478	491	487	505	820	829	842	903	928
Unit + High pressure dual pump option		kg		489	498	504	517	513	531	865	874	891	940	965
Unit + High pressure single pump option + Buffer tank module		kg		859	868	874	887	883	901	1253	1262	1275	1336	1361
Unit + High pressure dual pump option + Buffer tank module		kg		885	894	900	913	909	927	1298	1307	1324	1373	1398
<b>Compressors</b>														
Hermetic Scroll 48.3 r/s														
Circuit A		Qty		2	2	2	2	2	2	3	3	3	2	2
Circuit B		Qty		-	-	-	-	-	-	-	-	-	2	2
No. of control stages		Qty		2	2	2	2	2	2	3	3	3	4	4
<b>Refrigerant with micro-channel coils<sup>(3)</sup></b>														
R410A														
Circuit A		kg		4.7	5.3	5.9	6.7	6.2	7.3	10.7	10.8	11.4	6.5	7.4
		tCO <sub>2</sub> eq		9.8	11.1	12.3	14.0	12.9	15.2	22.3	22.6	23.8	13.6	15.5
Circuit B		kg		-	-	-	-	-	-	-	-	-	6.5	7.4
		tCO <sub>2</sub> eq		-	-	-	-	-	-	-	-	-	13.6	15.5

\* In accordance with standard EN14511-3:2013.

C1 Cooling mode conditions: water type heat exchanger inlet/outlet temperature 12°C/7°C, outdoor air temperature 35°C, evaporator fouling level 0 m<sup>2</sup>/kW.

C2 Cooling mode conditions: water type heat exchanger inlet/outlet temperature 23°C/18°C, outdoor air temperature 35°C, evaporator fouling level 0 m<sup>2</sup>/kW.

IPLV.SI Calculations based on standard performances (in accordance with AHRI 551-591).

(1) In dB ref=10-12 W, 'A' weighted. Declared dual-number noise emission values in accordance with ISO 4871 (with an associated uncertainty of +/-3dB(A)).

Measured in accordance with ISO 9614-1.

(2) In dB ref 20μPa, 'A' weighted. Declared dual-number noise emission values in accordance with ISO 4871 (with an associated uncertainty of +/-3dB(A)).

For information, calculated from the sound power Lw(A).

(3) Values are guidelines only. Refer to the unit name plate.

(4) On delivery, the vessels are preinflated to a standard value, which may not be the optimum one for the installation. To enable the water volume to be varied as desired, adapt the inflation pressure to a value close to that which corresponds to the static height of the installation. Fill the installation with water (bleeding out any air) at a pressure more than 10 to 20 kPa higher than the vessel pressure.



Eurovent certified values

## TECHNICAL CHARACTERISTICS - COOLING ONLY



AQUACIAT LD		150	180	200	240	260	300	360	390	450	520	600
<b>Oil charge</b>		POE SZ160 (EMKARATE RL 32-3MAF).										
Circuit A	l	5.8	7.2	7.2	7.2	7	7	10.8	10.5	10.5	7	7
Circuit B	l	-	-	-	-	-	-	-	-	-	7	7
<b>Control</b>		Connect Touch Control										
Minimum output	%	50	50	50	50	50	50	33	33	33	25	25
<b>Air heat exchanger</b>		All-aluminium micro-channel coil										
<b>Fans - Standard unit</b>												
Quantity		1	1	1	1	1	1	2	2	2	2	2
Maximum total air flow	l/s	3885	3883	3687	3908	5013	5278	6940	6936	7370	10026	10556
Maximum rotation speed	r/s	12	12	12	12	16	16	12	12	12	16	16
<b>Water heat exchanger</b>		Direct expansion, plate heat exchanger										
Water content	l	2.6	3	3.3	4	4.8	5.6	8.7	9.9	11.3	12.4	14.7
Max water-side operating pressure without hydraulic module	kPa	1000	1000	1000	1000	1000	1000	1000	1000	1000	1000	1000
<b>Hydraulic module (option)</b>		Pump, Victaulic screen filter, relief valve, water and air bleed valves, pressure sensors										
Single or dual pump (as required)												
Expansion tank volume (option)	l	12	12	12	12	12	12	35	35	35	35	35
Expansion vessel pressure <sup>(4)</sup>	bar	1	1	1	1	1	1	1.5	1.5	1.5	1.5	1.5
Max. water-side operating pressure with hydraulic module	kPa	400	400	400	400	400	400	400	400	400	400	400
<b>Buffer tank module (option)</b>		Pump, Victaulic screen filter, relief valve, water and air bleed valves, pressure sensors										
Single or dual pump (as required)												
Water volume	l	250	250	250	250	250	250	250	250	250	250	250
Expansion tank volume (option)	l	18	18	18	18	18	18	35	35	35	35	35
Expansion vessel pressure <sup>(4)</sup>	bar	1	1	1	1	1	1	1.5	1.5	1.5	1.5	1.5
Max. water-side operating pressure with hydraulic module	kPa	400	400	400	400	400	400	400	400	400	400	400
<b>Water connections with or without hydraulic module</b>		Victaulic										
Connections	inch	2	2	2	2	2	2	2	2	2	2	2
External diameter	mm	60.3	60.3	60.3	60.3	60.3	60.3	60.3	60.3	60.3	60.3	60.3
<b>Casing paint</b>		Colour code RAL 7035 and RAL7024										

\* In accordance with standard EN14511-3:2013.

C1 Cooling mode conditions: water type heat exchanger inlet/outlet temperature 12°C/7°C, outdoor air temperature 35°C, evaporator fouling level 0 m<sup>2</sup>K/W.

C2 Cooling mode conditions: water type heat exchanger inlet/outlet temperature 23°C/18°C, outdoor air temperature 35°C, evaporator fouling level 0 m<sup>2</sup>K/W.

IPLV.SI Calculations based on standard performances (in accordance with AHRI 551-591).

- (1) In dB ref=10-12 W, 'A' weighted. Declared dual-number noise emission values in accordance with ISO 4871 (with an associated uncertainty of +/-3dB(A)). Measured in accordance with ISO 9614-1.
- (2) In dB ref 20µPa, 'A' weighted. Declared dual-number noise emission values in accordance with ISO 4871 (with an associated uncertainty of +/-3dB(A)).

For information, calculated from the sound power L<sub>w</sub>(A).

- (3) Values are guidelines only. Refer to the unit name plate.
- (4) On delivery, the vessels are preinflated to a standard value, which may not be the optimum one for the installation. To enable the water volume to be varied as desired, adapt the inflation pressure to a value close to that which corresponds to the static height of the installation. Fill the installation with water (bleeding out any air) at a pressure more than 10 to 20 kPa higher than the vessel pressure.



Eurovent certified values



## TECHNICAL CHARACTERISTICS - REVERSIBLE HEAT PUMP



AQUACIAT ILD				150	180	200	240	260	300	302	360	390	450	520	600
<b>Cooling</b>															
Standard unit	C1	Nominal capacity	kW	37.7	43.1	49.4	58.0	63.1	70.2	77.0	84.9	95.1	112.4	130.5	148.2
Full load performances*	C1	EER	kW/kW	2.80	2.66	2.61	2.72	2.66	2.43	2.75	2.66	2.66	2.65	2.73	2.54
	C1	Eurovent class cooling		C	D	D	C	D	E	C	D	D	D	C	D
	C2	Nominal capacity	kW	47.1	53.9	62.7	70.7	78.2	88.5	96.5	106.9	116.6	141.9	161.6	185.2
	C2	EER	kW/kW	3.23	3.11	3.04	3.08	3.04	2.81	3.14	3.09	3.05	3.05	3.12	2.88
Seasonal efficiency*	C1	ESEER	kW/kW	3.74	3.72	3.74	3.55	3.55	3.37	3.78	3.71	3.82	3.98	3.69	3.62
<b>Heating</b>															
Standard unit	H1	Nominal capacity	kW	41.5	46.3	51.7	59.3	65.9	75.0	78.9	89.5	97.4	111.8	130.4	149.7
Full load performances*	H1	COP	kW/kW	3.05	3.02	3.01	3.01	2.98	2.85	3.11	3.05	3.06	3.00	2.94	2.86
	H1	Eurovent class cooling		B	B	B	B	C	C	B	B	B	B	C	C
	H2	Nominal capacity	kW	42.3	46.4	53.2	61.2	68.0	77.6	81.7	92.2	100.1	116.3	134.5	154.7
	H2	COP	kW/kW	3.69	3.69	3.76	3.72	3.64	3.46	3.78	3.80	3.76	3.68	3.61	3.47
Seasonal efficiency**	H2	SCOP	kW/kW	3.32	3.39	3.53	3.40	3.40	3.28	3.51	3.50	3.57	3.54	3.44	3.42
	H2	ηs heat	%	130	133	138	133	133	128	137	137	140	139	135	134
	H2	Prated	kW	35.50	31.63	36.30	43.81	50.14	55.67	56.83	81.54	72.28	84.16	99.38	110.91
Part Load integrated values		IPLV.SI	kW/kW	4.464	4.447	4.409	4.127	4.102	4.033	4.475	4.314	4.378	4.795	4.246	4.295
<b>Sound levels</b>															
<b>Standard unit</b>															
Sound power <sup>(1)</sup>		dB(A)		80	81	81	86	87	87	84	84	84	84	90	90
Sound pressure at 10 m <sup>(2)</sup>		dB(A)		49	49	49	55	55	55	52	52	52	52	58	58
<b>Unit + Xtra Low Noise option</b>															
Sound power <sup>(1)</sup>		dB(A)		79	80	80	80	80	80	83	83	83	83	83	83
Sound pressure at 10 m <sup>(2)</sup>		dB(A)		48	48	48	48	48	48	51	51	51	51	51	51
<b>Dimensions</b>															
Length	mm			1090	1090	1090	1090	1090	1090	2270	2270	2270	2270	2270	2270
Width	mm			2109	2109	2109	2109	2109	2109	2123	2123	2123	2123	2123	2123
Height	mm			1440	1440	1440	1440	1440	1440	1440	1440	1440	1440	1440	1440
Height with Buffer Tank Module	mm			2040	2040	2040	2040	2040	2040	2040	2040	2040	2040	2040	2040
<b>Operating weight<sup>(3)</sup></b>															
Standard unit	kg			497	506	543	549	559	564	777	896	905	979	1053	1057
Unit + High pressure single pump option	kg			539	548	585	591	601	606	844	963	972	1050	1127	1131
Unit + High pressure dual pump option	kg			565	574	611	617	627	632	889	1008	1017	1098	1164	1168
Unit + High pressure single pump option + Buffer tank module	kg			935	943	981	986	996	1001	1276	1395	1404	1482	1560	1563
Unit + High pressure dual pump option + Buffer tank module	kg			961	969	1006	1012	1022	1027	1321	1440	1449	1531	1597	1600
<b>Compressors</b>															
Hermetic Scroll 48.3 r/s															
Circuit A	Qty			2	2	2	2	2	2	2	3	3	3	2	2
Circuit B	Qty			-	-	-	-	-	-	-	-	-	-	2	2
No. of control stages	Qty			2	2	2	2	2	2	2	3	3	3	4	4
<b>Refrigerant<sup>(3)</sup></b>															
R-410A															
Circuit A	kg			12.5	13.5	16.5	17.5	18	16.5	21.5	27.5	28.5	33	19	18.5
	tCO <sub>2</sub> eq			26.1	28.2	34.5	36.5	37.6	34.5	44.9	57.4	59.5	68.9	39.7	38.6
Circuit B	kg			-	-	-	-	-	-	-	-	-	-	19	18.5
	tCO <sub>2</sub> eq			-	-	-	-	-	-	-	-	-	-	39.7	38.6
<b>Oil charge</b>															
POE SZ160 (EMKARATE RL 32-3MAF).															
Circuit A	l			5.8	7.2	7.2	7.2	7.0	7.0	7.2	7.0	7.0	7.0	7.0	7.0
Circuit B	l			-	-	-	-	-	-	-	-	-	-	7.0	7.0

\* In accordance with standard EN14511-3:2013.

\*\* In accordance with standard EN14825:2013, average climate conditions.

C1 Cooling mode conditions: water type heat exchanger inlet/outlet temperature 12°C/7°C, outdoor air temperature 35°C, evaporator fouling level 0 m<sup>2</sup>/K/W.

C2 Cooling mode conditions: water type heat exchanger inlet/outlet temperature 23°C/18°C, outdoor air temperature 35°C, evaporator fouling level 0 m<sup>2</sup>/K/W.

H1 Heating mode conditions: water type heat exchanger inlet/outlet temperature 40°C/45°C, db/wb outdoor air temperature 7°C/6°C, evaporator fouling level 0 m<sup>2</sup>/K/W.

H2 Heating mode conditions: water type heat exchanger inlet/outlet temperature 30°C/35°C, db/wb outdoor air temperature 7°C/6°C, evaporator fouling level 0 m<sup>2</sup>/K/W.

IPLV.SI Calculations based on standard performances (in accordance with AHRI 551-591).

(1) In dB ref=10-12 W, 'A' weighted. Declared dual-number noise emission values in accordance with ISO 4871 (with an associated uncertainty of +/-3dB(A)).

Measured in accordance with ISO 9614-1 and certified by EUROVENT

(2) In dB ref 20μPa, 'A' weighted. Declared dual-number noise emission values in accordance with ISO 4871 (with an associated uncertainty of +/-3dB(A)). Value calculated from the sound power Lw(A).

(3) Weight given as a guide. Refer to the unit name plate.



Eurovent certified values

## TECHNICAL CHARACTERISTICS - REVERSIBLE HEAT PUMP



AQUACIAT ILD		150	180	200	240	260	300	302	360	390	450	520	600
<b>Power control</b>		Connect Touch Control											
Minimum capacity	%	50	50	50	50	50	50	50	33	33	33	25	25
<b>Air heat exchanger</b>		Grooved copper tube and aluminium fins											
<b>Fans</b>													
Quantity	1	1	1	1	1	1	1	2	2	2	2	2	2
Maximum total air flow	l/s	3692	3690	3910	5285	5284	5282	7770	7380	7376	7818	10568	10568
Maximum rotation speed	r/s	12	12	12	16	16	16	12	12	12	12	16	16
<b>Water heat exchanger</b>		Direct expansion, plate heat exchanger											
Water content	l	2.6	3	4	4.8	4.8	5.6	8.7	8.7	9.9	11.3	12.4	14.7
Max water-side operating pressure without hydraulic module	kPa	1000	1000	1000	1000	1000	1000	1000	1000	1000	1000	1000	1000
<b>Hydraulic module (option)</b>		Pump, Victaulic screen filter, relief valve, water and air bleed valves, pressure sensors											
Single or dual pump (as required)													
Expansion tank volume (option)	l	12	12	12	12	12	12	12	35	35	35	35	35
Expansion vessel pressure <sup>(4)</sup>	bar	1	1	1	1	1	1	1	1.5	1.5	1.5	1.5	1.5
Max. water-side operating pressure with hydraulic module	kPa	400	400	400	400	400	400	400	400	400	400	400	400
<b>Buffer tank module (option)</b>		Pump, Victaulic screen filter, relief valve, water and air bleed valves, pressure sensors											
Single or dual pump (as required)													
Water volume	l	250	250	250	250	250	250	250	250	250	250	250	250
Expansion tank volume (option)	l	18	18	18	18	18	18	18	35	35	35	35	35
Expansion vessel pressure <sup>(4)</sup>	bar	1	1	1	1	1	1	1	1.5	1.5	1.5	1.5	1.5
Max. water-side operating pressure with hydraulic module	kPa	400	400	400	400	400	400	400	400	400	400	400	400
<b>Water connections with/without hydraulic module</b>		Victaulic											
Diameter	inch	2	2	2	2	2	2	2	2	2	2	2	2
External diameter	mm	60.3	60.3	60.3	60.3	60.3	60.3	60.3	60.3	60.3	60.3	60.3	60.3
<b>Casing paint</b>		Colour code RAL 7035 and RAL7024											

- (4) On delivery, the vessels are preinflated to a standard value, which may not be the optimum one for the installation. To enable the water volume to be varied as desired, adapt the inflation pressure to a value close to that which corresponds to the static height of the installation. Fill the installation with water (bleeding out any air) at a pressure more than 10 to 20 kPa higher than the vessel pressure.

## ELECTRICAL SPECIFICATIONS

LD / ILD Standard unit (without hydraulic module)		150	180	200	240	260	300	302	360	390	450	520	600
<b>Power circuit</b>													
Nominal voltage	V-ph-Hz	400-3-50											
Voltage range	V	360-440											
<b>Control circuit supply</b>		24 V via internal transformer											
<b>Nominal unit current draw<sup>(3)</sup></b>													
Circuit A + B	A	25.6	29	33	36	42.4	52.8	53.4	55.4	61.7	77.3	84.8	105.6
<b>Maximum unit power input<sup>(2)</sup></b>													
Circuit A + B	kW	19.5	22.3	24.5	27.9	31.2	35.8	35.6	42.3	45.6	52.5	62.4	71.6
<b>Unit Cosine Phi at maximum power<sup>(2)</sup></b>		0.83	0.81	0.81	0.83	0.81	0.78	0.78	0.83	0.81	0.79	0.81	0.78
<b>Maximum unit current draw (Un-10%)<sup>(5)</sup></b>													
Circuit A + B	A	38	49.2	51.4	58.4	74.8	79.6	80.2	89	110.3	117.5	149.6	159.2
<b>Maximum unit current draw (Un)<sup>(4)</sup></b>													
Circuit A&B - Standard unit	A	34.8	44.8	46.8	52.8	67	73	73.6	80.6	98.6	107.6	134	146
<b>Maximum start-up current, standard unit (Un)<sup>(1)</sup></b>													
Circuit A + B	A	113.8	134.8	142.8	145.8	176	213	213.6	173.6	207.6	247.6	243	286
<b>Maximum start-up current, unit with soft start (Un)<sup>(1)</sup></b>													
Circuit A + B	A	74.7	86.5	93.8	96.2	114.4	139.8	139.8	130.4	155.4	181.4	186.4	215.4

- (1) Maximum instantaneous starting current (maximum operating current of the smallest compressor(s) + fan current + locked rotor current of the largest compressor).
- (2) Power input, at the unit's permanent operating limits (indication given on the unit's name plate).
- (3) Standardised EUROVENT conditions, water type heat exchanger input/output = 12°C/7°C, outdoor air temperature = 35°C.
- (4) Maximum unit current at 400V, during non-permanent operation (indication given on the unit's name plate)
- (5) Maximum unit current at 360V, during non-permanent operation

### Short circuit current withstand capability (TN system<sup>(1)</sup>)

AQUACIAT LD / ILD	150	180	200	240	260	300	302	360	390	450	520	600
<b>Value without upstream protection</b>												
Short time (1s) assigned current - I <sub>cw</sub> - kA eff	3.36	3.36	3.36	3.36	3.36	3.36	3.36	5.62	5.62	5.62	5.62	5.62
Allowable peak assigned current - I <sub>pk</sub> - kA pk	20	20	20	20	20	15	15	20	20	15	20	15
<b>Value with upstream protection</b>												
Conditional short circuit assigned current I <sub>cc</sub> - kA eff	40	40	40	40	40	40	40	40	40	40	30	30
Associated Schneider circuit breaker Compact type range <sup>(2)</sup>	NS100H	NS100H	NS100H	NS100H	NS100H	NS100H	NS100H	NS100H	NS100H	NS160H	NS160H	NS250H

- (1) Type of system earthing
- (2) If another current limiter protective device is used, its time/current activation and heat thermal restriction I<sup>2</sup>t limits must be at least equivalent to those of the recommended Schneider circuit breaker.  
The short circuit current stability values given above are for the TN system.

## PARTIAL RECOVERY WITH DESUPERHEATER



The AQUACIAT range may be equipped as an option with an energy recovery function using a desuperheater

Heat from gases released by the compressors is recovered directly by a type of heat exchanger called a desuperheater located on the unit to produce free, additional hot water.

This optional configuration requires assembly in our factories and is by order only

### ■ Refrigerating circuit diagram

This refrigeration diagram illustrates a unit with a desuperheater on each refrigerating circuit. For heat recovery to be possible, the unit must be operating. For the same cooling capacity, the desuperheater provides a source of free hot water and lowers the unit's electrical power consumption.

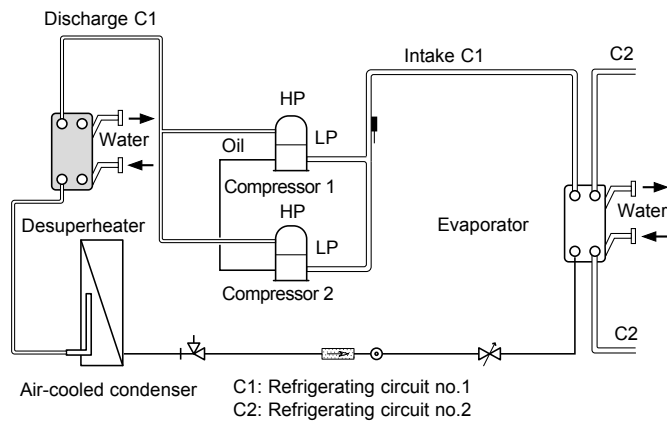

### ■ Hydraulic connections: configuration and precautions

The hydraulic supply for each desuperheater is delivered in parallel. In order to ensure that the unit can start and operate under the correct conditions, the desuperheater circuit water loop must be as short as possible and be able to increase quickly in temperature. The minimum desuperheater water inlet temperature must be 25°C. It may require the use of a three-way valve with its controller and a sensor controlling the minimum water inlet temperature.

#### Note:

The water loop for the desuperheater circuit must include an expansion vessel and a valve. Special attention should be paid when selecting the expansion vessel as the recovery water circuit can reach 120°C if the pump is turned off or if no hot water is consumed.

### ■ Operating limits

Operating mode	COOLING		HEATING		
	Minimum	Maximum	Minimum	Maximum	
<b>Desuperheater</b>					
Water inlet temperature at start-up	°C	25	60	25	60
Water outlet temperature during operation	°C	30	65	30	65
<b>Air heat exchanger</b>					
Outdoor air temperature during operation	°C	-10*	46	-10	48

\* With winter operation option

## PARTIAL RECOVERY WITH DESUPERHEATER



### ■ Technical characteristics

LD, partial heat recovery mode		150	180	200	240	260	300	360	390	450	520	600
Standard unit	kg	459	467	496	521	505	541	841	853	878	939	1002
Unit + High pressure single pump option	kg	500	509	538	563	547	583	908	919	949	1013	1076
Unit + High pressure dual pump option	kg	526	535	564	589	572	609	953	964	997	1050	1113
Unit + High pressure single pump option + Buffer tank module	kg	896	905	934	959	943	979	1341	1352	1382	1446	1509
Unit + High pressure dual pump option + Buffer tank module	kg	922	931	960	985	968	1005	1386	1397	1430	1483	1546
<b>Refrigerant for copper tube/aluminium fin coils<sup>(1)</sup></b>		R410A										
Circuit A	kg	8	9	12.5	15	12.5	15	19	20	23	12.5	16
Circuit B	kg	-	-	-	-	-	-	-	-	-	12.5	16
<b>Air heat exchanger</b>		Grooved copper tube and aluminium fins										
<b>Desuperheater on circuits A and B</b>		Plate heat exchanger										
Water content	l	0.549	0.549	0.549	0.549	0.732	0.732	0.976	0.976	0.976	0.732	0.732
Water content	l	-	-	-	-	-	-	-	-	-	0.732	0.732
Max water-side operating pressure without hydraulic module	kPa	1000	1000	1000	1000	1000	1000	1000	1000	1000	1000	1000
<b>Water connections</b>		Cylindrical male gas thread										
Diameter	inch	1	1	1	1	1	1	1	1	1	1	1
External diameter	mm	42	42	42	42	42	42	42	42	42	42	42

ILD, partial heat recovery mode		150	180	200	240	260	300	302	360	390	450	520	600
Standard unit	kg	506	515	552	558	569	574	787	907	916	990	1068	1072
Unit + High pressure single pump option	kg	548	557	594	600	611	616	854	974	983	1061	1142	1146
Unit + High pressure dual pump option	kg	574	583	620	626	637	642	899	1019	1028	1109	1179	1183
Unit + High pressure single pump option + Buffer tank module	kg	944	952	990	995	1006	1011	1286	1406	1415	1493	1575	1578
Unit + High pressure dual pump option + Buffer tank module	kg	970	978	1015	1021	1032	1037	1331	1451	1460	1542	1612	1615
<b>Refrigerant for copper tube/aluminium fin coils<sup>(1)</sup></b>		R410A											
Circuit A	kg	12.5	13.5	16.5	17.5	18	16.5	21.5	27.5	28.5	33	19	18.5
Circuit B	kg	-	-	-	-	-	-	-	-	-	-	19	18.5
<b>Air heat exchanger</b>		Grooved copper tube and aluminium fins											
<b>Desuperheater on circuits A and B</b>		Plate heat exchanger											
Water content	l	0.549	0.549	0.549	0.732	0.732	0.732	0.732	0.976	0.976	0.976	0.732	0.732
Water content	l	-	-	-	-	-	-	-	-	-	-	0.732	0.732
Max water-side operating pressure without hydraulic module	kPa	1000	1000	1000	1000	1000	1000	1000	1000	1000	1000	1000	1000
<b>Water connections</b>		Cylindrical male gas thread											
Diameter	inch	1	1	1	1	1	1	1	1	1	1	1	1
External diameter	mm	42	42	42	42	42	42	42	42	42	42	42	42

(1) Weight given as a guide.

## PARTIAL RECOVERY WITH DESUPERHEATER



### ■ Performance

#### Heating capacity recovery by the desuperheaters

##### LD water chiller

LD 150 - 600	Water inlet temperature for the desuperheater (°C)								
	45			50			55		
	Qhr	q	pΔ	Qhr	q	pΔ	Qhr	q	pΔ
	kW	l/s	kPa	kW	l/s	kPa	kW	l/s	kPa
150	12.9	0.31	6.1	10.9	0.26	4.4	9.0	0.21	3.1
180	16.5	0.40	9.5	14.3	0.34	7.4	12.0	0.29	5.2
200	18.1	0.43	11.7	15.4	0.37	8.5	12.8	0.31	6.1
240	19.3	0.46	12.9	16.6	0.40	9.8	13.7	0.33	6.9
260	24.3	0.58	11.8	21.0	0.50	9.2	17.5	0.42	6.5
300	28.6	0.68	16.3	24.4	0.58	12.1	20.6	0.49	8.8
360	30.5	0.73	11.4	25.8	0.62	8.2	21.5	0.51	5.8
390	36.4	0.87	16.0	31.9	0.76	12.4	27.0	0.64	8.9
450	43.1	1.03	22.6	37.4	0.89	17.2	31.6	0.75	12.3
520 <sup>(1)</sup>	47.1	1.12	11.3	39.7	0.95	8.3	33.0	0.79	5.9
600 <sup>(1)</sup>	54.0	1.29	15.0	45.6	1.09	10.7	38.3	0.92	7.8

##### Application data

Water type heat exchanger inlet/outlet water temperature: 12/7°C  
 Outdoor air temperature: 35°C  
 Desuperheater water inlet/outlet difference: 10 K  
 Evaporator fluid: chilled water  
 Fouling coefficient: 0.18 x 10<sup>-4</sup> m<sup>2</sup>.K/W

##### ILD heat pumps

ILD 150 - 600 / Cooling Mode	Water inlet temperature for the desuperheater (°C)								
	45			50			55		
	Qhr	q	pΔ	Qhr	q	pΔ	Qhr	q	pΔ
	kW	l/s	kPa	kW	l/s	kPa	kW	l/s	kPa
150	10.9	0.26	4.4	9.1	0.22	3.1	7.1	0.18	2.1
180	14.4	0.34	7.5	12.2	0.29	5.4	10.0	0.24	3.7
200	17.2	0.41	10.5	14.7	0.35	7.8	12.3	0.29	5.6
240	17.4	0.44	6.6	15.1	0.36	4.6	12.3	0.29	3.0
260	21.4	0.51	9.3	17.9	0.43	6.7	14.7	0.35	4.8
300	26.8	0.64	14.7	22.5	0.54	10.4	18.8	0.45	7.5
302	23.9	0.57	12.1	21.2	0.51	7.8	16.3	0.39	5.8
360	28.1	0.67	9.9	23.9	0.57	7.1	19.7	0.47	5.1
390	33.9	0.81	14.0	28.3	0.68	10.1	23.7	0.57	7.2
450	37.7	0.90	17.5	31.7	0.76	12.4	26.5	0.63	8.9
520 <sup>(1)</sup>	42.9	1.03	9.4	35.5	0.85	6.7	29.1	0.7	4.5
600 <sup>(1)</sup>	52.3	1.25	14.1	44.2	1.06	10.1	36.9	0.88	7.1

##### Application data

Water type heat exchanger inlet/outlet water temperature: 12/7°C  
 Outdoor air temperature: 35°C  
 Desuperheater water inlet/outlet difference: 10 K  
 Evaporator fluid: chilled water  
 Fouling coefficient: 0.18 x 10<sup>-4</sup> m<sup>2</sup>.K/W

ILD 150 - 600 / Heating Mode	Water inlet temperature for the desuperheater (°C)								
	45			50			55		
	Qhr	q	pΔ	Qhr	q	pΔ	Qhr	q	pΔ
	kW	l/s	kPa	kW	l/s	kPa	kW	l/s	kPa
150	10.1	0.24	3.8	8.3	0.20	2.7	6.8	0.16	1.8
180	11.1	0.27	4.6	9.3	0.22	3.3	7.7	0.18	2.3
200	14.0	0.33	7.1	11.8	0.28	5.2	9.9	0.24	3.6
240	14.3	0.34	4.4	11.8	0.28	3.0	9.4	0.22	2.0
260	17.1	0.41	6.3	14.4	0.34	4.5	11.9	0.28	3.1
300	19.1	0.46	7.8	16.0	0.38	5.6	13.2	0.32	3.9
302	17.5	0.42	6.6	14.6	0.35	4.8	11.7	0.28	3.2
360	21.4	0.51	6.0	17.7	0.42	4.1	14.7	0.35	2.8
390	20.6	0.49	5.1	16.5	0.39	3.4	12.7	0.30	2.0
450	23.0	0.55	6.9	18.5	0.44	4.7	14.5	0.35	3.0
520 <sup>(1)</sup>	32.0	0.77	5.5	26.7	0.64	3.8	21.6	0.52	2.6
600 <sup>(1)</sup>	37.5	0.90	7.3	31.2	0.75	5.4	25.4	0.61	3.7

##### Application data

Water type heat exchanger inlet/outlet temperature: 40/45°C  
 Outdoor air temperature: 7°C  
 Desuperheater water inlet/outlet difference: 10 K  
 Evaporator fluid: chilled water  
 Fouling coefficient: 0.18 x 10<sup>-4</sup> m<sup>2</sup>.K/W

Qhr Total heating capacity recovered by the desuperheater(s) (kW)

q Total water flow rate on the desuperheater loop (l/s)

pΔ Water pressure drop per desuperheater (kPa)

(1) Sizes 520 and 600 are equipped with 2 desuperheaters, one per circuit.



## XTRA FAN OPERATING PRESSURE VENTILATION

The AQUACIAT range can be equipped as an option with the XTRAFAN operating pressure ventilation.

### ■ Functions

The XTRAFAN offers a wide range of functions, making a whole host of flexible installation conditions possible, such as:

- The option of installation in a confined space, for example on a terrace surrounded by walls, where only an air supply with static pressure of between 100 and 200 pascals within a duct enables use without recycling or mixing of air at the condenser intake,
- Installation in an urban area in which noise is a particular issue, where operation is only possible by adapting a sound trap to the supply air,
- A self-adjusting variable speed function which allows "all-season" cooling, fully secured for industrial processes, including during harsh winter conditions with an external temperature of -20°C,
- The freedom to precisely adjust the fan speed on-site to what is "strictly necessary" to obtain the optimum air supply pressure, or the maximum acceptable sound limit for the site on which the unit is located,
- An improvement in the energy efficiency and electrical consumption of the unit, in direct proportion to the load required by the installation

The performances (cooling capacity, heating capacity, power input, energy efficiency) depend on the rotation speed of the fans, and therefore on the required operating pressure in the duct.

The sound level at the duct outlet and the level radiated around the machine depends on the operating pressure.

### ■ Precautions for installation

On-site installation of a packaged reversible air-to-water unit requires some safety measures to be taken, particularly if it is installed in a machine room. For example, the evacuation of condensates specific to these units, including at very low outdoor temperatures.

During defrosting cycles, reversible units are liable to discharge a large amount of water onto the ground, which must be drained, as well as steam from the fan discharge which can damage the air discharge ducts. The ground supporting the unit must be perfectly watertight and capable of collecting and draining the defrosted water, including during freezing periods. It is recommended that the unit is raised by approximately 300 mm.

If an air discharge duct is installed on site, its weight must not be supported by the roof of the unit. Each fan must be connected independently

### Aquaciat cooling only

Duct pressure drop	Speed of rotation of the fan (r/s)	Variation in the power input	Variation in the cooling output
<b>LD 150-240 / LD 360-450</b>			
0	12	0.943	1.019
50	13.33	0.962	1.012
100	14.66	0.98	1.006
130	15.46	0.99	1.003
160	16.26	1	1
200	17.31	1.012	0.998
240	18.36	1.023	0.996
<b>LD 260-300 / LD 520-600</b>			
0	15.83	0.929	1.018
50	16.81	0.944	1.016
100	17.78	0.964	1.014
130	18.36	0.978	1.011
160	18.36	1	1
180	18.36	1.019	0.991

### Aquaciat reversible

Duct pressure drop	Speed of rotation of the fan (r/s)	Variation in the power input	Variation in the cooling or heating output (*)
<b>Cooling mode</b>			
<b>ILD 150-200 / ILD 302-450</b>			
0	12	0.943	1.019
50	13.33	0.962	1.012
100	14.66	0.980	1.006
130	15.46	0.990	1.003
160	16.26	1.000	1.000
200	17.31	1.012	0.998
240	18.36	1.023	0.996
<b>ILD 240-300 / ILD 520-600</b>			
0	15.83	0.929	1.018
50	16.81	0.944	1.016
100	17.78	0.964	1.014
130	18.36	0.978	1.011
160	18.36	1.000	1.000
180	18.36	1.019	0.991
<b>Heating mode</b>			
<b>ILD 150-200 / ILD 302-450</b>			
0	18.36	0.990	1.016
50	18.36	0.990	1.012
100	18.36	0.990	1.009
130	18.36	1.000	1.005
160	18.36	1.000	1.000
200	18.36	1.000	0.994
240	18.36	1.010	0.981
<b>ILD 240-300 / ILD 520-600</b>			
0	18.36	1.000	1.026
50	18.36	1.000	1.02
100	18.36	1.000	1.011
130	18.36	1.000	1.007
160	18.36	1.000	1.000
180	18.36	1.001	0.993

(\*) Cooling output, cooling mode  
Heating output, heating mode

## INTELLIGENTLY-DESIGNED ACOUSTICS

To comply with the various restrictions on integration, the AQUACIAT has two sound finish levels enabling it to be easily integrated into a number of zones without causing disruption to users or their neighbours.

### ■ Basic version

The distinguishing feature of the AQUACIAT range is its rigorous design incorporating "noiseless" assembly techniques to reduce vibrations and sources of noise:

- New generation scroll compressors with a continuous scrolling motion to lessen vibrations
- Compressor structure separated from the unit by anti-vibration mounts
- Pipes separated from the unit structure
- Fans made from a synthetic material, with aerodynamic blades offering an optimised profile. Optimised coil-fan combination, the result of many hours of study of the thermal and acoustic properties in our Research and Innovation Centre, to ensure a linear flow of air without turbulence, to limit noise to an acceptable acoustic spectrum.
- The Connect Touch controller automatically adjusts the fan air flow rate according to the outdoor air temperature and the unit's load rate which enables the sound level to be significantly reduced, particularly at night, mid-season, morning and evening, which totals more than 75% of the time the unit is used

### ■ Xtra Low Noise option

In this version, the compressors are housed in jackets and the fan rotation speed is reduced whilst ensuring the output and thermal performance remain optimised.

### ■ Night mode

The AQUACIAT has a Night Mode enabling the sound level to be limited at night or when the building is unoccupied (according to the user programming) by controlling the output and the fan rotation speed.

### ■ Acoustic signature

As important as the sound power level, the acoustic signature reflects the noise disturbance generated by the unit.

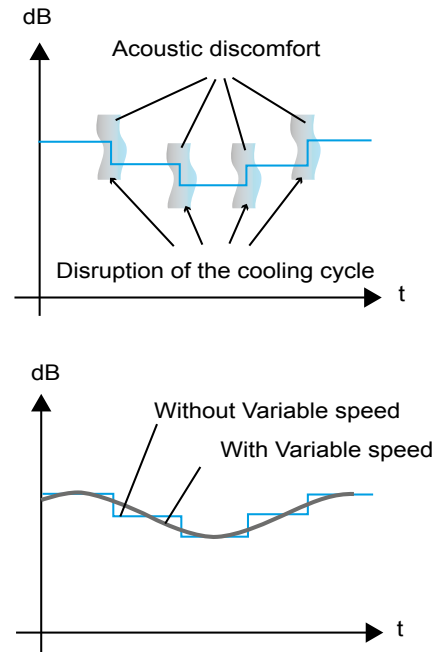

The AQUACIAT can be equipped as an option with a variable speed motor, enabling the fan to start gradually (all-season operation).

It avoids the increases in noise linked to the on/off sequences, thereby improving the unit's acoustic signature.

Similarly, the installation of a variable speed pump enables the sound level of the pump function to be reduced by adjusting the pump speed to what is strictly necessary. The soft start improves the signature and reduces nuisance noise.

With all these benefits and its two acoustic finish levels (Standard and Xtra Low Noise), the AQUACIAT can be integrated into any site, ensuring any constraints in terms of the sound environment can be met.

## SOUND LEVELS

### LD standard version

#### ■ Sound power levels ref $10^{-12}$ W $\pm$ 3 dB (Lw)

At nominal EN 14511-3: 2013 operating conditions – Cooling mode

AQUACIAT LD	SOUND POWER LEVEL SPECTRUM (dB)						Overall power level dB(A)
	125 Hz	250 Hz	500 Hz	1000 Hz	2000 Hz	4000 Hz	
150	77	79	79	75	72	67	80
180	77	79	79	76	73	67	81
200	77	79	79	76	72	68	81
240	77	79	79	76	74	69	81
260	81	84	84	83	77	73	87
300	81	84	85	83	77	71	87
360	80	82	82	79	76	71	84
390	80	82	82	79	76	74	84
450	80	82	82	79	77	71	84
520	84	87	87	86	80	76	90
600	84	87	88	86	80	74	90

#### ■ Sound pressure level ref $2 \times 10^{-5}$ Pa $\pm$ 3 dB (Lp)

Measurement conditions: free field, 10 metres from machine, 1.50 metres above floor level, directivity 2

AQUACIAT LD	SOUND PRESSURE SPECTRUM (dB)						Overall pressure level dB(A)
	125 Hz	250 Hz	500 Hz	1000 Hz	2000 Hz	4000 Hz	
150	45	47	47	43	40	36	49
180	45	47	47	44	41	36	49
200	45	47	47	44	41	36	49
240	45	47	47	44	42	37	49
260	50	52	53	51	45	41	55
300	50	52	53	51	46	39	55
360	48	50	50	47	44	39	52
390	48	50	50	47	44	42	52
450	48	50	50	47	45	40	52
520	53	55	56	54	48	44	58
600	53	55	56	54	48	42	58

**NB:** Sound pressure levels depend on the installation conditions of each system. As such, the levels listed here are given for information only. Only the sound power levels are comparable and certified.

## SOUND LEVELS

### LD Standard, XTRA LOW NOISE version

#### ■ Sound power levels ref $10^{-12}$ W $\pm 3$ dB (Lw)

At nominal EN 14511-3: 2013 operating conditions – Cooling mode

AQUACIAT LD	SOUND POWER LEVEL SPECTRUM (dB)						Overall power level dB(A)
	125 Hz	250 Hz	500 Hz	1000 Hz	2000 Hz	4000 Hz	
150	77	79	78	75	70	63	79
180	77	79	79	75	70	63	80
200	77	79	79	75	70	63	80
240	77	79	78	75	70	64	80
260	77	79	79	75	71	66	80
300	77	79	79	75	71	64	80
360	80	82	81	78	73	66	83
390	80	82	82	78	73	68	83
450	80	82	82	78	74	67	83
520	80	82	82	78	74	69	83
600	80	82	82	78	74	67	83

#### ■ Sound pressure level ref $2 \times 10^{-5}$ Pa $\pm 3$ dB (Lp)

Measurement conditions: free field, 10 metres from machine, 1.50 metres above floor level, directivity 2

AQUACIAT LD	SOUND PRESSURE SPECTRUM (dB)						Overall pressure level dB(A)
	125 Hz	250 Hz	500 Hz	1000 Hz	2000 Hz	4000 Hz	
150	45	47	47	43	38	31	48
180	45	47	47	43	38	31	48
200	45	47	47	43	38	31	48
240	45	47	47	43	39	32	48
260	45	47	47	43	39	35	48
300	45	47	47	43	39	33	48
360	48	50	50	46	41	34	51
390	48	50	50	46	41	37	51
450	48	50	50	46	42	35	51
520	48	50	50	46	42	37	51
600	48	50	50	46	42	36	51

**NB:** Sound pressure levels depend on the installation conditions of each system. As such, the levels listed here are given for information only. Only the sound power levels are comparable and certified.

## SOUND LEVELS

### ILD, Standard version

#### ■ Sound power levels ref $10^{-12}$ W $\pm$ 3 dB (L<sub>w</sub>)

At nominal EN 14511-3: 2013 operating conditions – Cooling mode

AQUACIAT ILD	SOUND POWER LEVEL SPECTRUM (dB)						Overall power level dB(A)
	125 Hz	250 Hz	500 Hz	1000 Hz	2000 Hz	4000 Hz	
150	77	79	79	75	72	67	80
180	77	79	79	76	73	67	81
200	77	79	79	76	72	68	81
240	81	84	84	83	77	71	86
260	81	84	84	83	77	73	87
300	81	84	85	83	77	71	87
302	80	82	82	78	76	70	84
360	80	82	82	79	76	71	84
390	80	82	82	79	76	74	84
450	80	82	82	79	77	71	84
520	84	87	87	86	80	76	90
600	84	87	88	86	80	74	90

#### ■ Sound pressure level ref $2 \times 10^{-5}$ Pa $\pm$ 3 dB (L<sub>p</sub>)

Measurement conditions: free field, 10 metres from machine, 1.50 metres above floor level, directivity 2

AQUACIAT ILD	SOUND PRESSURE SPECTRUM (dB)						Overall pressure level dB(A)
	125 Hz	250 Hz	500 Hz	1000 Hz	2000 Hz	4000 Hz	
150	45	47	47	43	40	36	49
180	45	47	47	44	41	36	49
200	45	47	47	44	41	36	49
240	50	52	53	51	45	39	55
260	50	52	53	51	45	41	55
300	50	52	53	51	46	39	55
302	45	50	50	47	44	38	52
360	48	50	50	47	44	39	52
390	48	50	50	47	44	42	52
450	48	50	50	47	45	40	52
520	53	55	56	54	48	44	58
600	53	55	56	54	48	42	58

**NB:** Sound pressure levels depend on the installation conditions of each system. As such, the levels listed here are given for information only. Only the sound power levels are comparable and certified.

## SOUND LEVELS

### ILD Standard, XTRA LOW NOISE version

#### ■ Sound power levels ref $10^{-12}$ W $\pm 3$ dB (Lw)

At nominal EN 14511-3: 2013 operating conditions – Cooling mode

AQUACIAT ILD	SOUND POWER LEVEL SPECTRUM (dB)						Overall power level dB(A)
	125 Hz	250 Hz	500 Hz	1000 Hz	2000 Hz	4000 Hz	
150	77	79	78	75	70	63	79
180	77	79	79	75	70	63	80
200	77	79	79	75	70	63	80
240	77	79	78	75	70	64	80
260	77	79	79	75	71	66	80
300	77	79	79	75	71	64	80
302	80	82	82	78	73	65	83
360	80	82	81	78	73	66	83
390	80	82	82	78	73	68	83
450	80	82	82	78	74	67	83
520	80	82	82	78	74	69	83
600	80	82	82	78	74	67	83

#### ■ Sound pressure level ref $2 \times 10^{-5}$ Pa $\pm 3$ dB (Lp)

Measurement conditions: free field, 10 metres from machine, 1.50 metres above floor level, directivity 2

AQUACIAT ILD	SOUND PRESSURE SPECTRUM (dB)						Overall pressure level dB(A)
	125 Hz	250 Hz	500 Hz	1000 Hz	2000 Hz	4000 Hz	
150	45	47	47	43	38	31	48
180	45	47	47	43	38	31	48
200	45	47	47	43	38	31	48
240	45	47	47	43	39	32	48
260	45	47	47	43	39	35	48
300	45	47	47	43	39	33	48
302	48	50	50	46	41	34	51
360	48	50	50	46	41	34	51
390	48	50	50	46	41	37	51
450	48	50	50	46	42	35	51
520	48	50	50	46	42	37	51
600	48	50	50	46	42	36	51

**NB:** Sound pressure levels depend on the installation conditions of each system. As such, the levels listed here are given for information only. Only the sound power levels are comparable and certified.



## SYSTEM WATER VOLUME - EVAPORATOR WATER FLOW RATE

The Connect Touch controller is equipped with anticipation logic making it highly flexible in adjusting operation to parameter drift, particularly on hydraulic systems with low water volumes. By adjusting compressor runtimes, it prevents short-cycle protection cycles from starting and, in most cases, eliminates the need for a buffer tank.

Note: The minimum volumes of chilled water are calculated for EUROVENT rated conditions:

- Cooling mode, LD version  
 - Chilled water temperature = 12°C/7°C  
 - Condenser air inlet temperature = 35°C

- Heating mode, ILD version  
 - Hot water temperature = 40°C/45°C  
 - Outdoor air temperature = 7°C

This value is applicable for most air conditioning applications (unit with fan coil units)

Note: For installations running with a low volume of water (unit with air handling unit) or for industrial processes, the buffer tank is essential.

### Minimum system water volume and water type heat exchanger flow rate

AQUACIAT LD	150	180	200	240	260	300	360	390	450	520	600	
Minimum system water volume, air conditioning application (litres)	121	140	164	182	207	243	181	205	240	204	240	
Minimum system water volume, industrial process application (litres)	304	351	410	454	518	608	452	513	601	510	601	
Min/max water type heat exchanger flow rate without hydraulic module <sup>(1)</sup> (l/s)	0.9 / 3	0.9 / 3.4	0.9 / 4.2	0.9 / 5	1 / 5	1.2 / 5.5	1.3 / 6.8	1.5 / 7.7	1.7 / 8.5	2 / 10.6	2.3 / 11.2	
Water type heat exchanger maximum flow rate, dual pump (l/s) <sup>(2)</sup>	Low pressure <sup>(3)</sup>	2.9	3.2	3.7	4.1	4.1	4.4	5.1	6.3	6.5	7.9	8.2
	High pressure <sup>(3)</sup>	3.4	3.8	4.4	5	5	5.2	6.2	6.5	8	8.7	8.9

- (1) Maximum flow rate for a pressure drop of 100 kPa in the water type heat exchanger  
 (2) Maximum flow rate for an operating pressure of 20 kPa (unit with low pressure pumps) or 50 kPa (high pressure).  
 (3) Maximum flow rate single pump 2 to 4% higher, depending on the sizes.

NOTE: For the Buffer Tank Module option, the volume of the tank must be taken into account (250 litres)

AQUACIAT ILD	150	180	200	240	260	300	302	360	390	450	520	600	
Minimum system water volume, air conditioning application (litres)	202	234	274	303	346	405	405	301	342	400	340	401	
Minimum system water volume, industrial process application (litres)	304	351	410	454	518	608	608	452	513	601	510	601	
Min/max water type heat exchanger flow rate without hydraulic module <sup>(1)</sup> (l/s)	0.9 / 3	0.9 / 3.4	0.9 / 4.2	0.9 / 5	1 / 5	1.2 / 5.5	1.2 / 6.8	1.3 / 6.8	1.5 / 7.7	1.7 / 8.5	2 / 10.6	2.3 / 11.2	
Water type heat exchanger maximum flow rate, dual pump (l/s) <sup>(2)</sup>	Low pressure <sup>(3)</sup>	2.9	3.2	3.7	4.1	4.1	4.4	5.1	5.1	6.3	6.5	7.9	8.2
	High pressure <sup>(3)</sup>	3.4	3.8	4.4	5	5	5.2	6.2	6.2	6.5	8	8.7	8.9

- (1) Maximum flow rate for a pressure drop of 100 kPa in the water type heat exchanger  
 (2) Maximum flow rate for an operating pressure of 20 kPa (unit with low pressure pumps) or 50 kPa (high pressure).  
 (3) Maximum flow rate single pump 2 to 4% higher, depending on the sizes.

NOTE: For the Buffer Tank Module option, the volume of the tank must be taken into account (250 litres)

## OPERATING RANGE

AQUACIAT devices have a broad field of application, enabling them to meet a range of heating and cooling requirements in the most varied of climates.

### Multi-application: air conditioning, heating, industrial processes

The AQUACIAT can be used for all traditional air conditioning and heating applications in sectors as varied as shared residential, hotels, shopping centres and offices.

### ■ Operating limits of the LD water chiller

#### Multi-climate: -20°C to +48°C

The AQUACIAT is equipped as standard with all the management devices and algorithms to enable all-season operation down to temperatures of 0°C, with the option of extending this to -20°C if the variable speed fan option is selected.

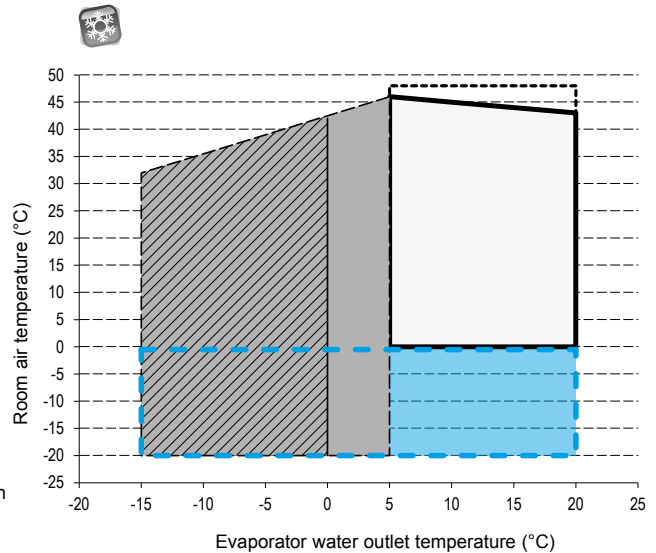
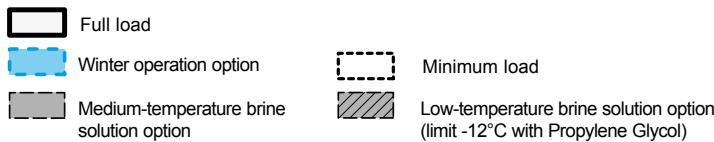

### ■ Operating limits of the ILD heat pump

#### Multi-climate

The design of the AQUACIAT makes it suitable for the majority of heating and air conditioning applications, regardless of the climate. Water heated to +40°C is guaranteed, even for outdoor temperatures of -10°C

#### Cooling mode from -10°C to +48°C

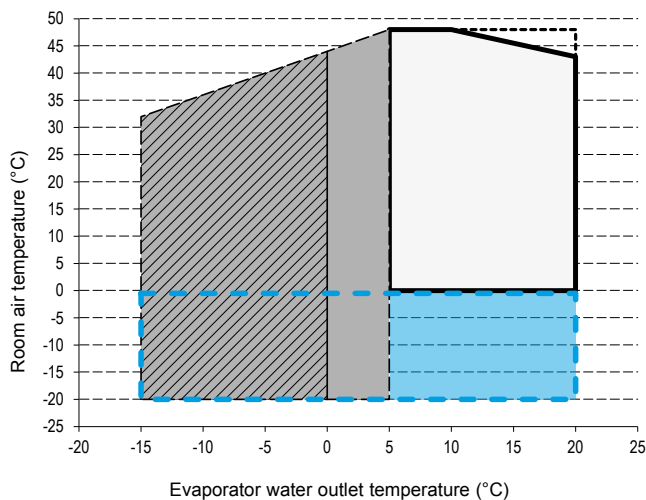

#### Heating mode from -15°C to +40°C

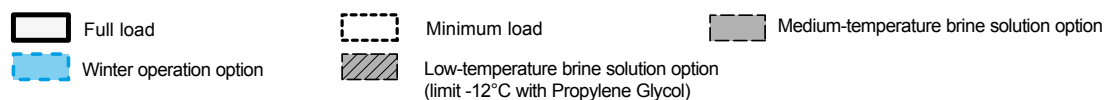
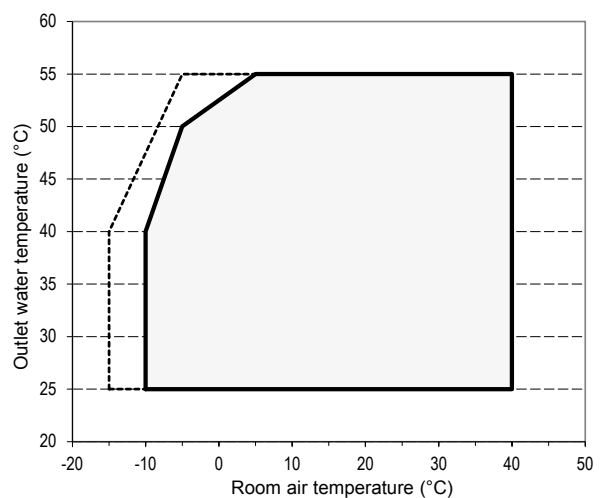

## HYDRAULIC SPECIFICATIONS

### Water pressure drop in the evaporator

Data applicable for pure water at 20°C

LD/ILD, 150-300 sizes

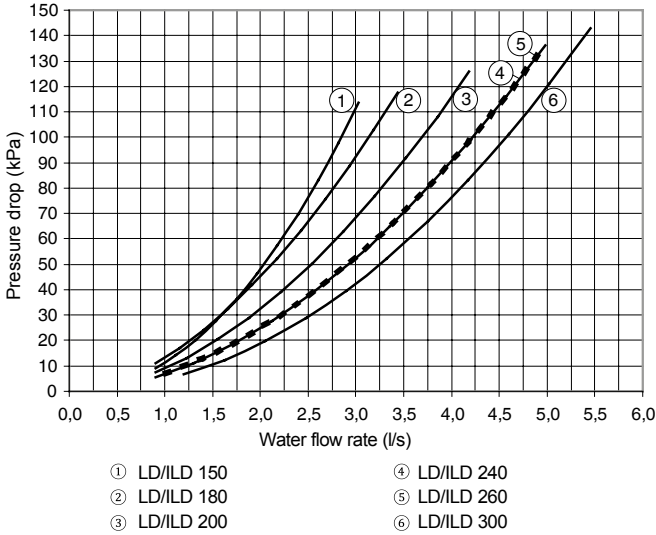

LD/ILD, 302-600 sizes

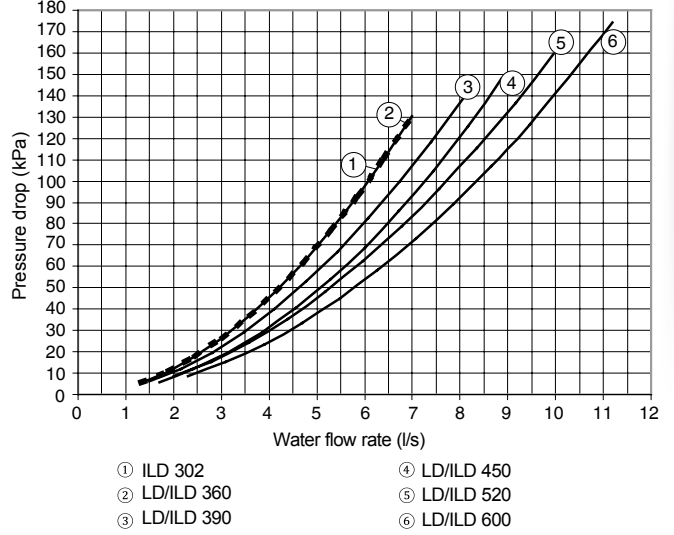

### Water pressure drop in the filter

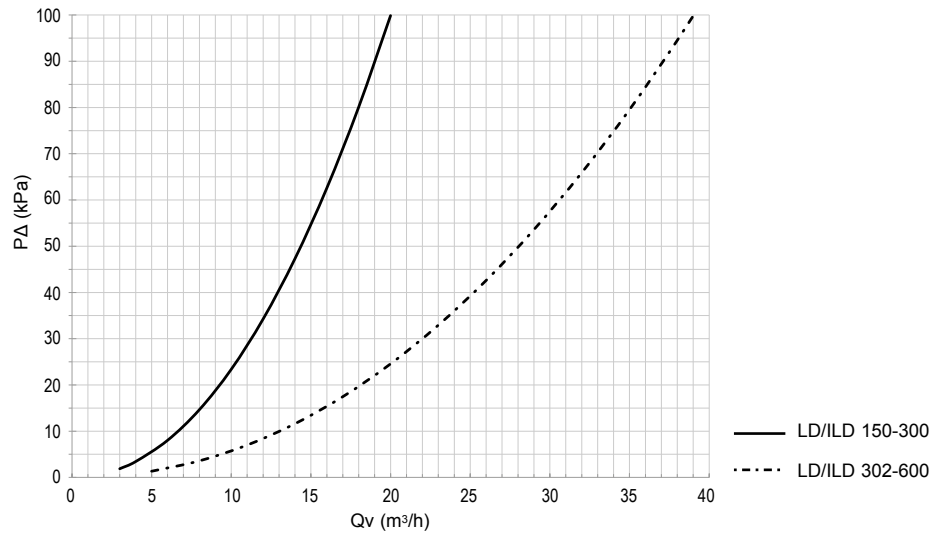

### Water pressure drop in the buffer tank

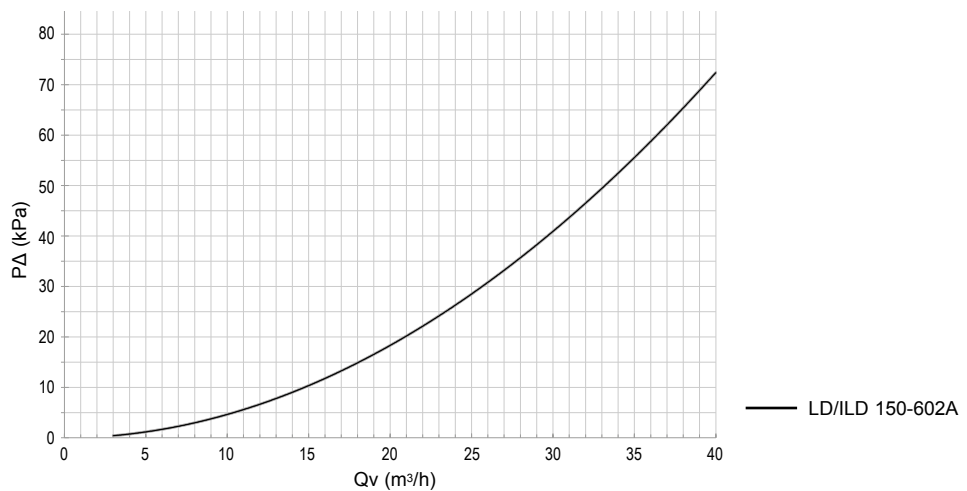

## HYDRAULIC SPECIFICATIONS

### ■ Available static pressure for the system

Units with hydraulic module (fixed speed pump or variable speed pump at 50 Hz).

Data applicable for:

- Pure water at 20°C
- Refer to the section "Evaporator water flow rate" for the minimum and maximum water flow rate values
- If a glycol/water mix is used, the maximum water flow rate is reduced.

#### Low pressure pumps

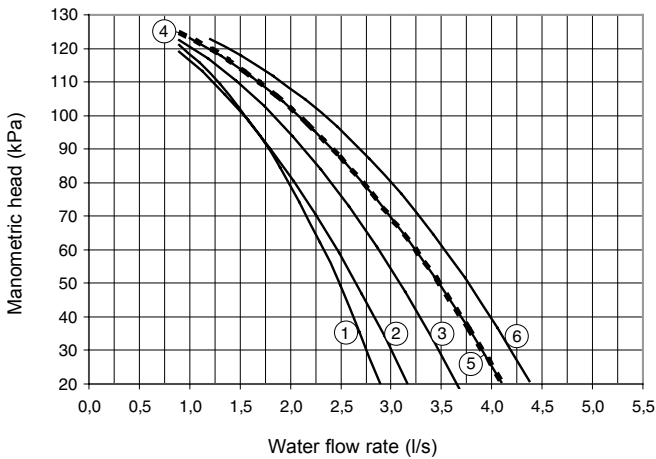

- |           |          |
|-----------|----------|
| ① ILD 150 | ④ LD 240 |
| ② LD 180  | ⑤ LD 260 |
| ③ LD 200  | ⑥ LD 300 |

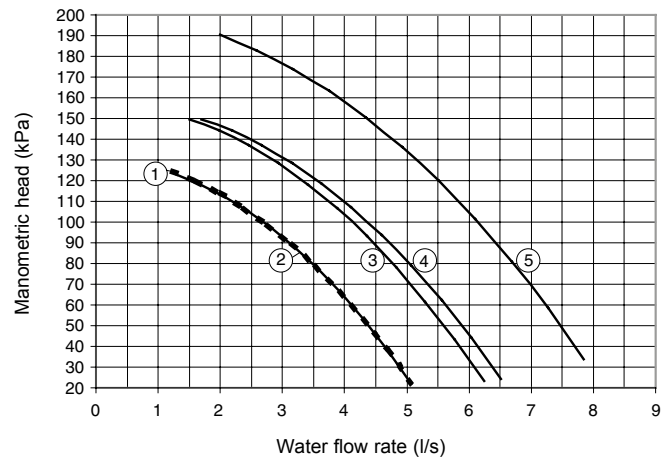

- |          |          |
|----------|----------|
| ① LD 360 | ④ LD 520 |
| ② LD 390 | ⑤ LD 600 |
| ③ LD 450 |          |

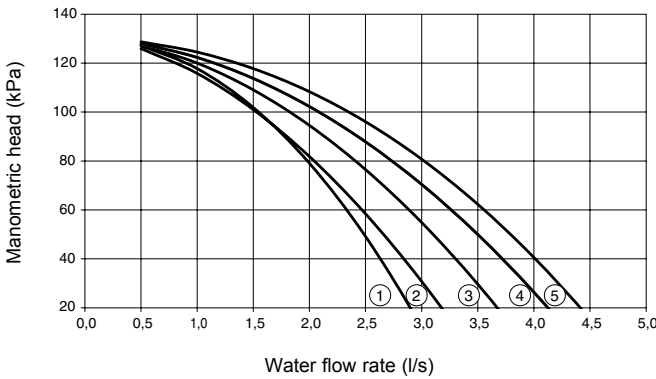

- |           |                 |
|-----------|-----------------|
| ① ILD 150 | ④ ILD 240 & 260 |
| ② ILD 180 | ⑤ ILD 300       |
| ③ ILD 200 |                 |

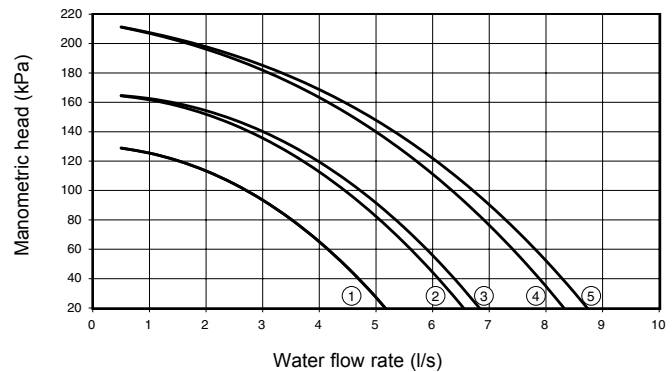

- |                 |           |
|-----------------|-----------|
| ① ILD 302 & 360 | ④ ILD 520 |
| ② ILD 390       | ⑤ ILD 600 |
| ③ ILD 450       |           |

## HYDRAULIC SPECIFICATIONS

### High pressure pumps

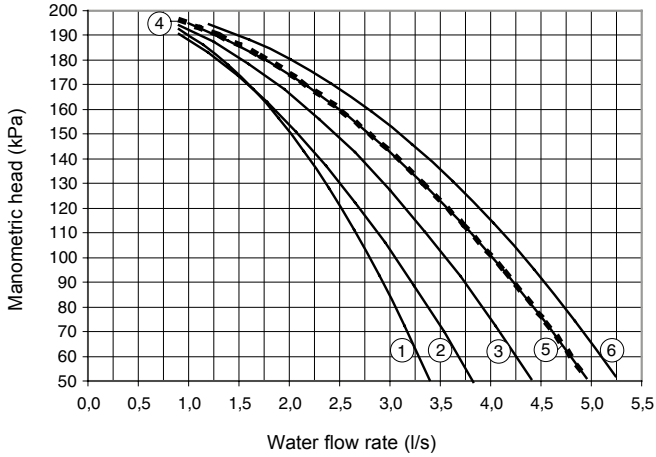

- |          |          |
|----------|----------|
| ① LD 150 | ④ LD 240 |
| ② LD 180 | ⑤ LD 260 |
| ③ LD 200 | ⑥ LD 300 |

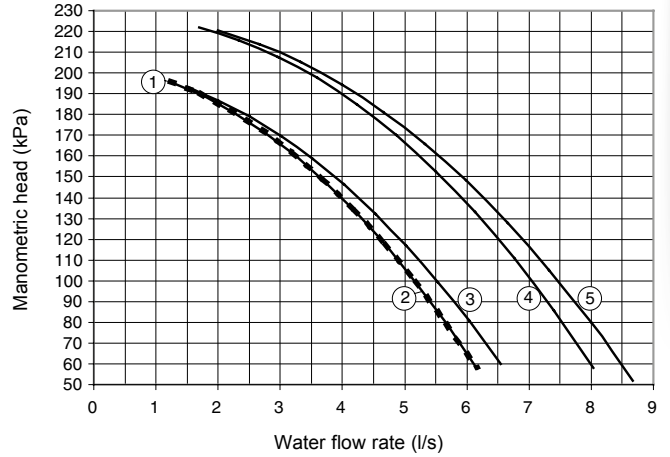

- |          |          |
|----------|----------|
| ① LD 360 | ④ LD 520 |
| ② LD 390 | ⑤ LD 600 |
| ③ LD 450 |          |

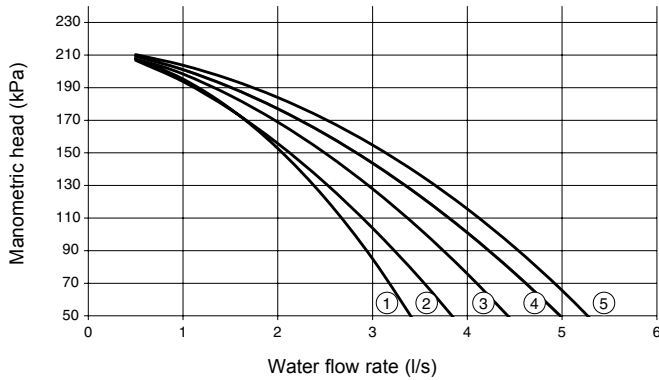

- |           |                 |
|-----------|-----------------|
| ① ILD 150 | ④ ILD 240 & 260 |
| ② ILD 180 | ⑤ ILD 300       |
| ③ ILD 200 |                 |

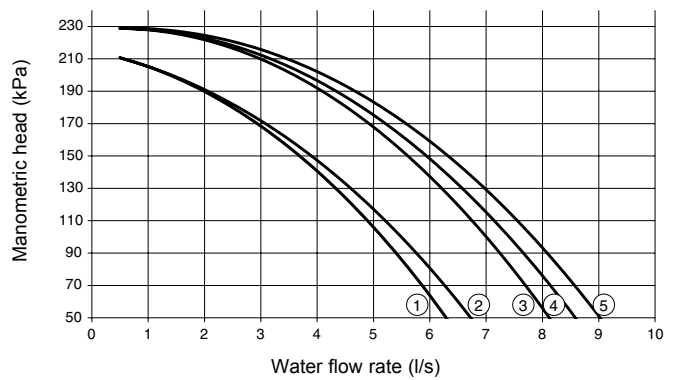

- |                 |           |
|-----------------|-----------|
| ① ILD 302 & 360 | ④ ILD 520 |
| ② ILD 390       | ⑤ ILD 600 |
| ③ ILD 450       |           |

## DIMENSIONS

### ■ AQUACIAT LD-ILD 150 to 300 Without buffer tank

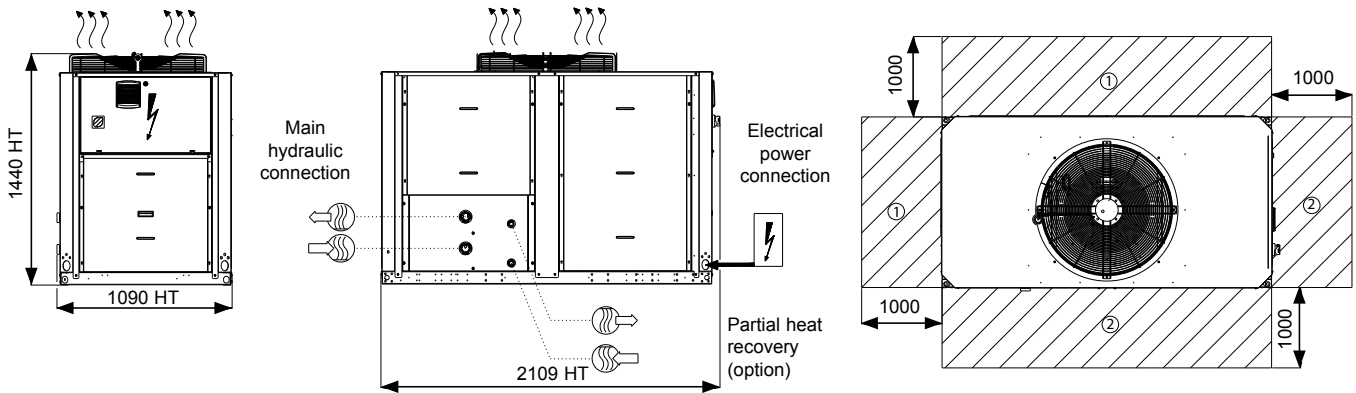

### ■ AQUACIAT LD-ILD 150 to 300 With buffer tank

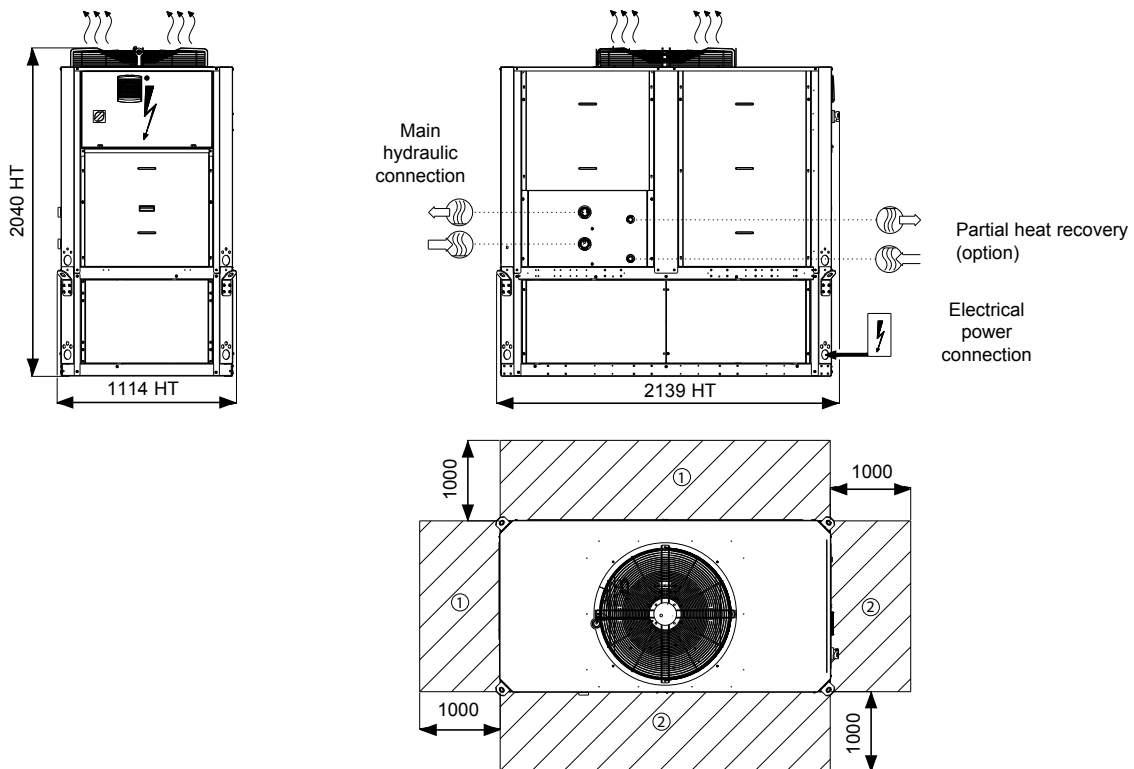

Key  
All dimensions in mm

- ① Clearance required for maintenance and air flow
- ② Clearance recommended for coil removal
- Water inlet
- Water outlet
- Air outlet, do not obstruct
- Electrical cabinet

Notes:  
Non-contractual drawings.

When designing a system, refer to the certified dimensional drawings provided with the unit or available on request.

Please refer to the certified dimensional drawings for the positioning of the fixing points, weight distribution points and centre of gravity coordinates.

## DIMENSIONS

### ■ AQUACIAT LD-ILD 302 to 600 Without buffer tank

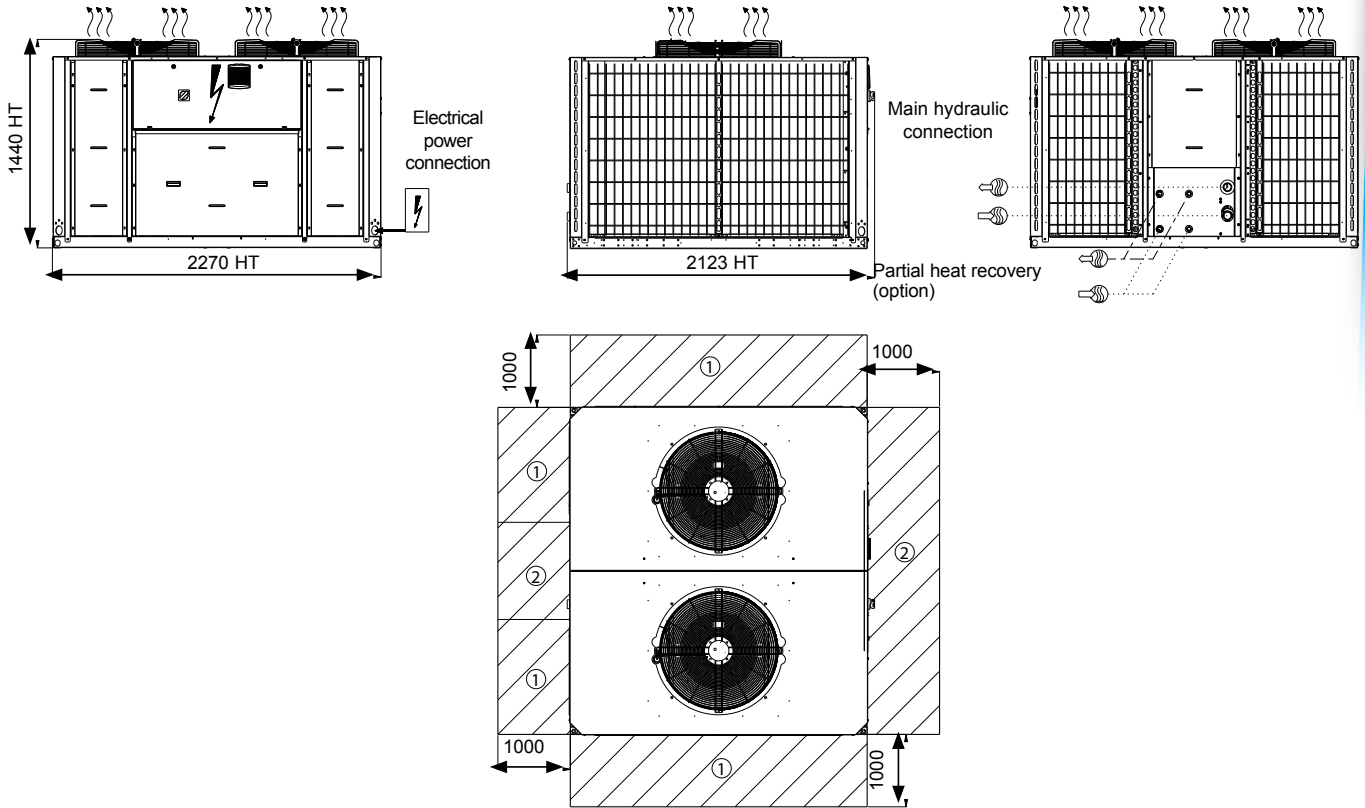

Key  
All dimensions in mm

- ① Clearance required for maintenance and air flow
- ② Clearance recommended for coil removal
- Water inlet
- Water outlet
- Air outlet, do not obstruct
- Electrical cabinet

Notes:  
Non-contractual drawings.

When designing a system, refer to the certified dimensional drawings provided with the unit or available on request.

Please refer to the certified dimensional drawings for the positioning of the fixing points, weight distribution points and centre of gravity coordinates.



## DIMENSIONS

### ■ AQUACIAT LD-ILD 302 to 600 With buffer tank

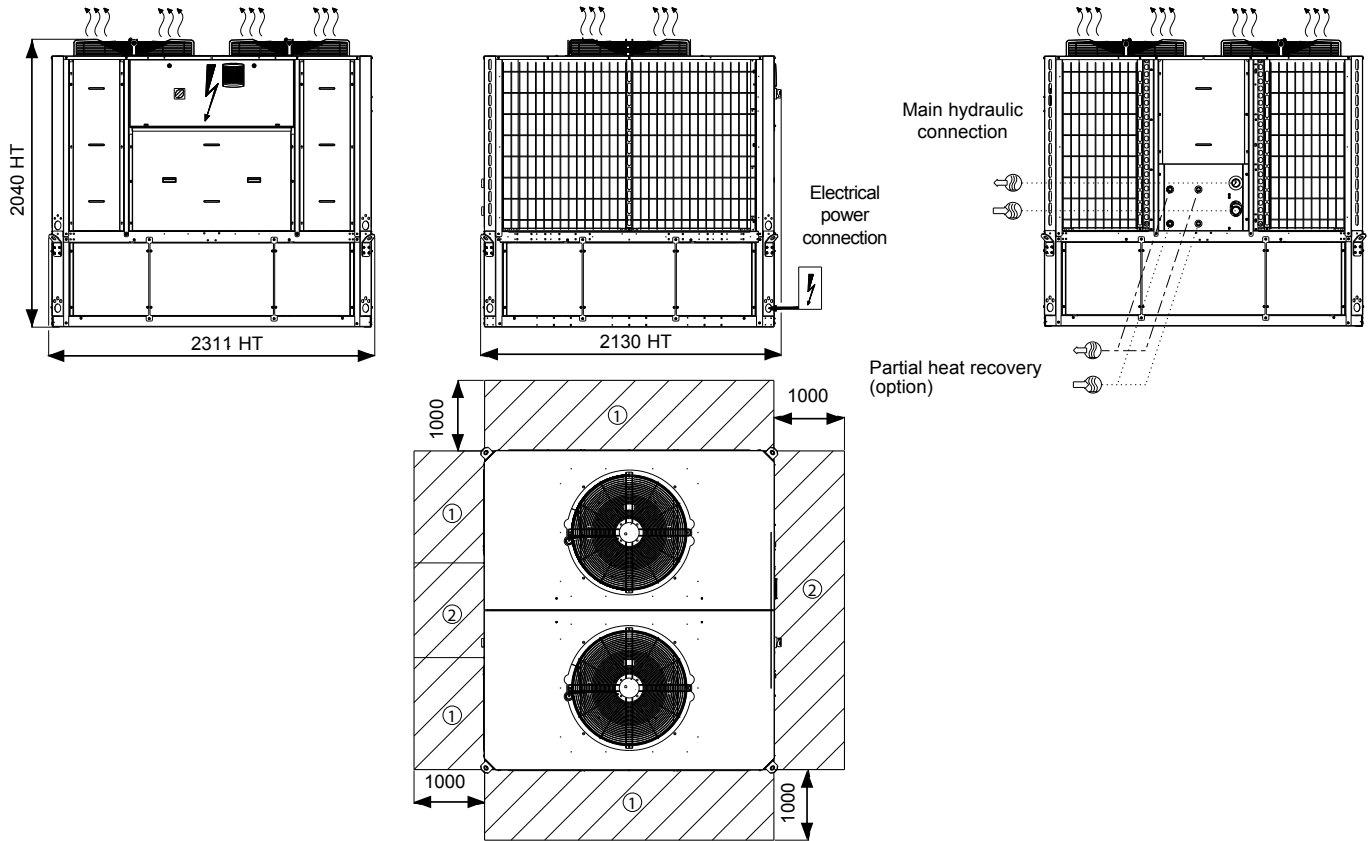

Key  
All dimensions in mm

- ① Clearance required for maintenance and air flow
- ② Clearance recommended for coil removal
- Water inlet
- Water outlet
- Air outlet, do not obstruct
- Electrical cabinet

Notes:  
Non-contractual drawings.

When designing a system, refer to the certified dimensional drawings provided with the unit or available on request.

Please refer to the certified dimensional drawings for the positioning of the fixing points, weight distribution points and centre of gravity coordinates.

## INSTALLATION RECOMMENDATIONS

### ■ Water quality criteria to be respected

Warning: It is essential that an 800-micron water filter be placed on the unit's water inlet during installation. The quality of the water used has a direct impact on the correct and compliant operation of the machine and its service life. This is particularly true if the water used clogs or corrodes components or promotes the growth of algae or micro-organisms. The water must be tested to determine whether it is suitable for the unit. It is also tested to determine whether chemical treatment is necessary and will suffice to make it of acceptable quality. This analysis should confirm whether or not the various machine components are compatible with the water they come into contact with on-site.

**Warning:** failure to follow these instructions will result in the immediate voiding of the unit's warranty.

### ■ Lifting and handling

The utmost safety precautions must be taken when lifting and handling the unit.

Always follow the lifting diagram on the unit and in the instruction manual.

Before attempting to lift the unit, make sure the path leading to its intended location is free from obstacles. Always keep the unit vertical when moving it. Never tip it or lie it on its side.

### ■ Choosing a location for the unit

AQUACIAT units are designed for outdoor installation. Precautions should be taken to protect them from freezing temperatures. Special attention should be paid to ensure sufficient free space (including at the top) to allow maintenance. The unit must be placed on a perfectly level, fireproof surface strong enough to support it when ready for operation. Noise pollution from auxiliary equipment such as pumps should be studied thoroughly.

Potential noise transmission routes should be studied, with assistance from an acoustical engineer if necessary, before installing the unit. It is strongly recommended that flexible couplings are placed over pipes and anti-vibration mounts are fitted underneath the unit (equipment available as an option) to reduce vibrations, and the noise this causes, as much as possible.

### ■ Fitting accessories supplied separately

A number of optional accessories may be delivered separately and installed on the unit on site.

You must follow the instructions in the manual.

### ■ Electrical connections

You must follow the instructions in the manual. All information concerning electrical connections is stated on the wiring diagrams provided with the unit. Always follow this information to the letter.

Electrical connections must be made in accordance with best current practices and applicable standards and regulations. Electrical cable connections to be made on-site:

- Electrical power supply to unit
- Contacts available as standard enabling the machine to be controlled remotely (optional)

It should be noted that the unit's electrical system is not protected against lightning strikes.

Therefore devices to protect against transient voltage surges must be installed on the system and inside the power supply unit.

### ■ Pipe connections

You must follow the instructions in the manual. All pipes must be correctly aligned and slope toward the system's drain valve. Pipes must be installed to allow sufficient access to the panels and fitted with heat insulation.

Pipe mountings and clamps must be separate to avoid vibrations and pressure on the unit. Water flow shut-off and control valves must be fitted when the unit is installed.

Pipe connections to be made on-site:

- Water supply with pressure-reducing valve
- Evaporator, condenser and drain

The following are a few examples of accessories essential to any hydraulic circuit, which must also be installed:

- Water expansion vessel
- Drain nozzles at pipe low points
- Exchanger shut-off valves equipped with filters
- Air vents at pipe high points
- Check the system's water capacity (install a buffer water tank if necessary)
- Flexible couplings on exchanger inlets and outlets

#### Warning:

- Pressure in the water circuits below 4 bar for units equipped with the hydraulic module.
- Place the expansion vessel upstream of the pump.
- Do not place any valves on the expansion vessel.
- Make sure the water circulation pumps are placed directly at the exchanger inlets.
- Make sure the pressure of the water drawn in by the circulation pumps is greater than or equal to the required minimum NPSH, particularly if the water circuits are "open".
- Test the water quality in accordance with the relevant technical specifications.
- Take the necessary precautions to protect the unit and hydraulic system from freezing temperatures (e.g. allow for the possibility of draining the unit). If glycol is added to prevent freezing, check its type and concentration before system start-up.
- Before making any final hydraulic connections, flush the pipes with clean water to remove any debris in the network



### ■ System start-up

CIAT or a CIAT-approved firm must perform system start-up on the units.

You must follow the instructions in the manual.

List of system start-up checks (non-exhaustive):

- Correct siting of unit
- Power supply protections
- Phases and direction of rotation
- Wiring connections on unit
- Direction of water flow in unit
- Cleanliness of water circuit
- Water flow rate at specified value
- Pressure in the refrigerating circuit
- Direction of rotation of compressors
- Water pressure drops and flow rates
- Operating readings

### ■ Maintenance operations

Specific preventive maintenance operations are required at regular intervals and should be performed by CIAT-approved contractors.

The operating parameters are read and noted on a "CHECK LIST" form to be returned to CIAT.

It is essential to comply with the instruction manual.

You must take out a maintenance contract with a CIAT-approved refrigeration equipment specialist. Such a contract is required even during the warranty period.

## CONTROL

### USER-FRIENDLY INTERFACE CONSOLE

- User-friendly 4.3 inch touchscreen.
- Information displayed in a choice of languages.
- Temperature and pressure readings.
- Operating and fault status diagnostics.
- Master/slave control of two machines in parallel.
- Fault memory management.
- Pump management.
- Time schedule.
- IP Web server.
- Programmable maintenance.
- Preventive maintenance.
- FGAS maintenance.
- E-mail alerts.



### REMOTE M2M MACHINE SUPERVISION

#### Two years of Full Serenity with:

- Monitoring of machine operation (operation overviews and curves, alarm logs).
- E-mail alerts for alarms (optional SMS alerts).
- Remote update of the M2M.
- Access to a log of machine operation data.
- Remote advice for using M2M.
- System start-up and operating readings.

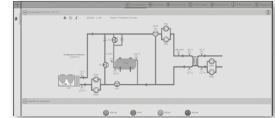

## PRODUCT FUNCTIONALITY

### POTENTIAL-FREE (DRY) CONTACTS AVAILABLE AS STANDARD

- Inputs:**
- Automatic operation control
  - Heating/cooling mode selection
  - Selection of setpoints 1 / 2
  - Power limitation

- Outputs:**
- General fault reporting
  - Circuit fault reporting
  - User fault reporting

- Additional inputs available as options:**
- Setpoint adjustable by 4-20 mA signal

- Additional outputs available as options:**
- On/off control for a boiler
  - 4-stage on/off management for additional heaters

### AVAILABLE OUTPUTS

- MODBUS-JBUS RTU (RS485) or TC/IP (standard) open protocol
- LONWORKS protocol (option)
- BACNET IP protocol (option)

Via potential-free (dry) contact

COMMUNICATION  
Customer CMS

Via BUS communication

## CIAT SYSTEM FUNCTIONALITY

Communication with Hysys system (generator, transmitter, air handling unit), controlled by an Easy CIATControl or Smart CIATControl touch tablet.

- **Logging** of consumption data and temperatures
- **Optimal Water®**: optimisation of producer performance based on building requirements
- **Optimal Stop and Start**: optimisation of the building restart time





→ Water chillers  
Heat pump

## AQUACIAT LD ILD

This document is non-contractual. As part of its policy of continual product improvement, CIAT reserves the right to make any technical modification it feels appropriate without prior notification.

### Head office

700 Avenue Jean Falconnier - B.P. 14  
01350 - Culoz - France  
Tel.: +33 (0)4 79 42 42 42  
Fax: +33 (0)4 79 42 42 10  
[www.ciat.com](http://www.ciat.com)



Compagnie Industrielle d'Applications Thermiques - S.A. with a registered capital of 26 728 480 € - R.C.S. Bourg-en-Bresse B 545 620 114