

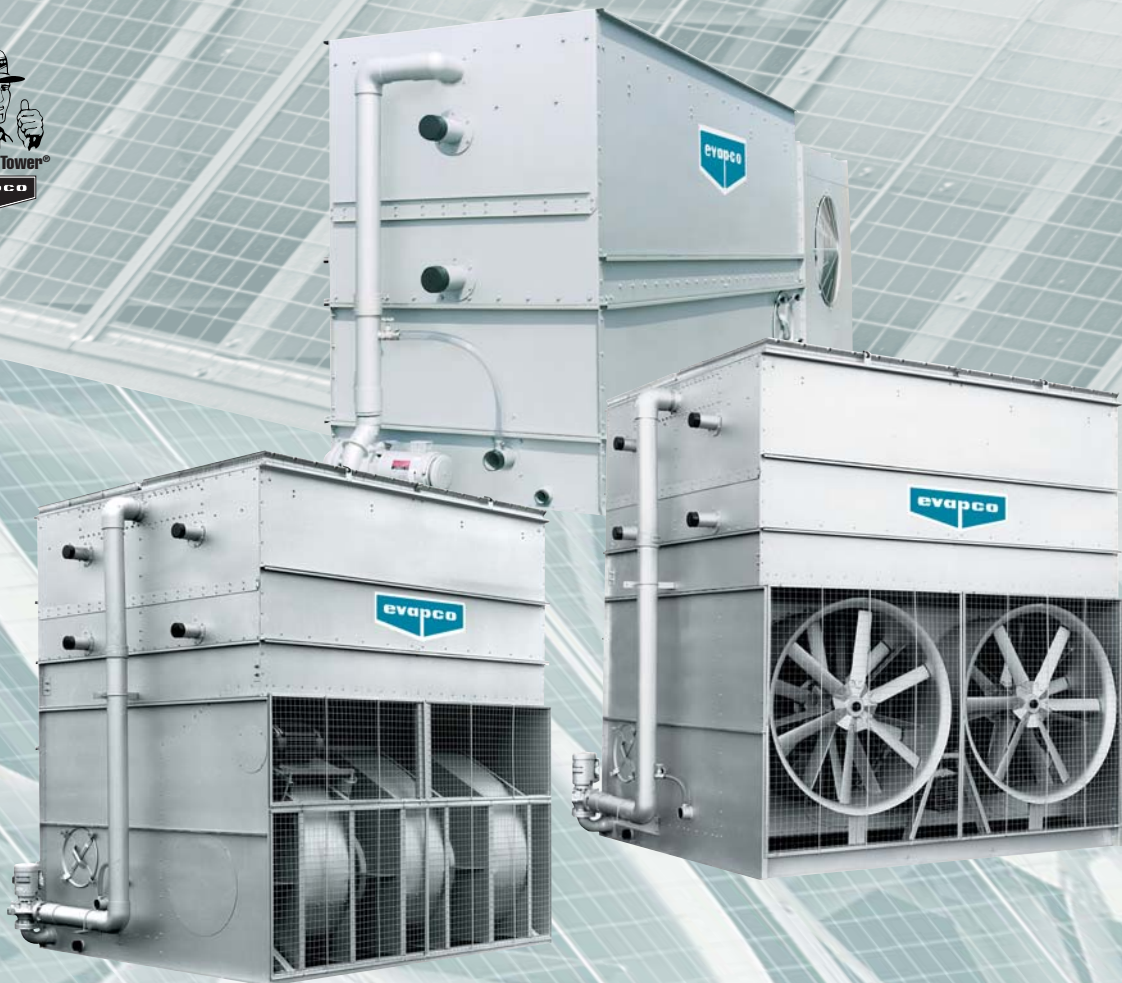

LSCB/LRC/PMCB Evaporative Condensers

Advanced Technology for the Future, Available Today



Exclusive Thermal-Pak® Coil
Z-725 Galvanized Steel Construction
Totally Enclosed Fan and
Pump Motors

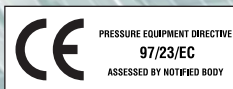

CERTIFIED EN ISO 9001:2000



EVAPCO offers a variety of evaporative condenser designs in

Each unit is a reflection of Evapco's commitment to excellence in engineering and manufacturing. An emphasis on research and development has resulted in many condenser innovations.

All Evapco condensers have the following features as standard:

- Patented* Thermal-Pak® Coil resulting in the maximum thermal performance available per plan area.
- Heavy Gauge Hot Dip Galvanized Steel construction assuring long operating life.
- Totally Enclosed Fan and Pump Motors.

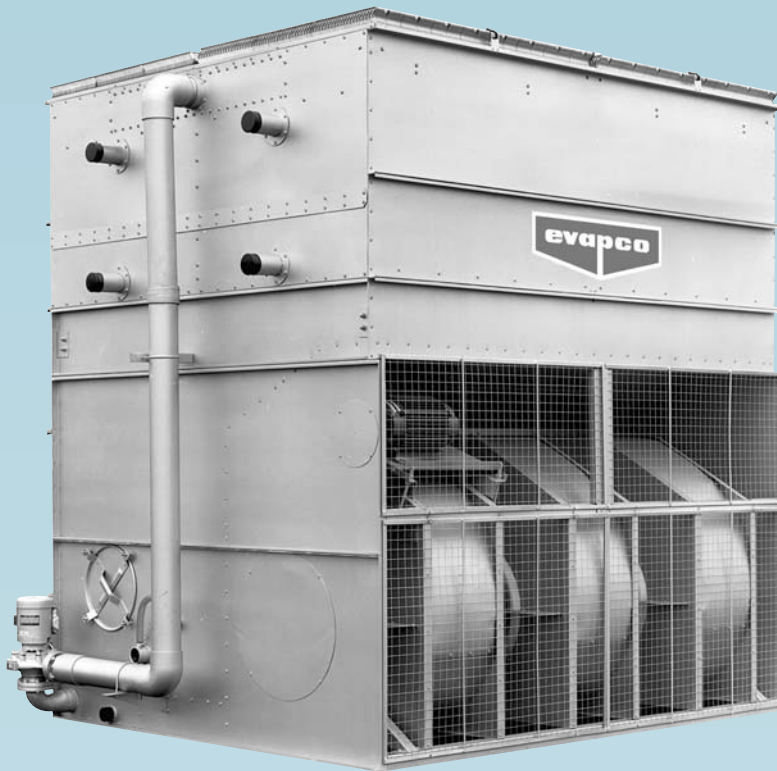

LSCB Series

LSCB centrifugal fan forced draft condensers are recommended for a wide range of applications. LSCB models are very quiet and ideal for applications where noise is a concern. In addition, sound attenuation packages are available to further reduce the sound levels.

The centrifugal fans can also operate against the static pressure loss of ductwork and are suitable for indoor installations, or those with inlet or outlet ductwork. These condensers are available in capacities from 155 to 6931 kW. Very quiet operation.



LRC Series

LRC condensers are forced draft, centrifugal fan models designed specifically for applications requiring low height. Their compact, yet user-friendly design makes them ideal for smaller applications from 108 to 1632 kW.

in numerous sizes to accommodate almost any application.

- Stainless Steel Suction Strainers easily removed for periodic cleaning.
- Proven Performance, Industrial Design and Quality Construction for years of Dependable Service.
- Evapco's Commitment to 100% Customer Satisfaction.

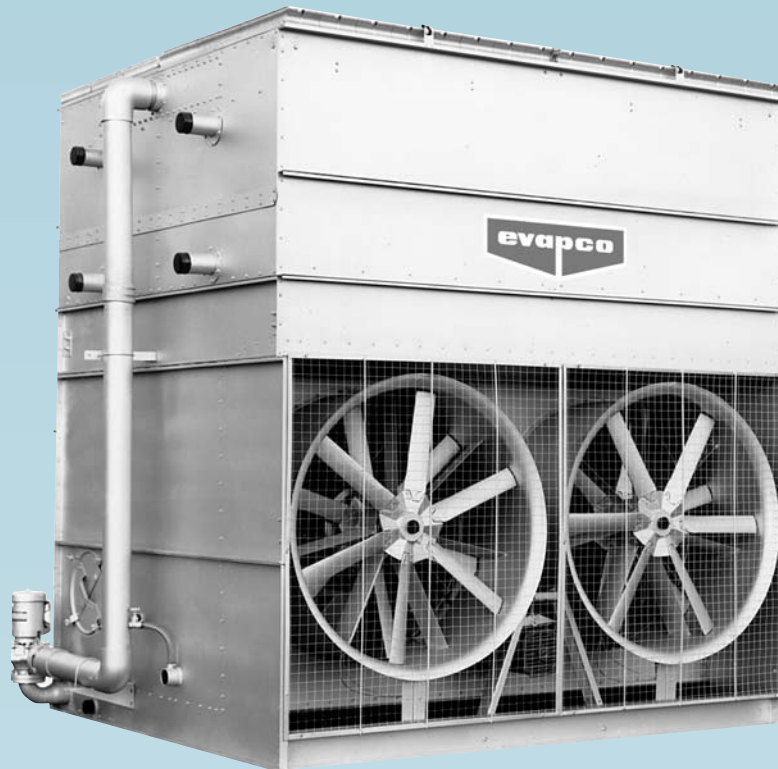
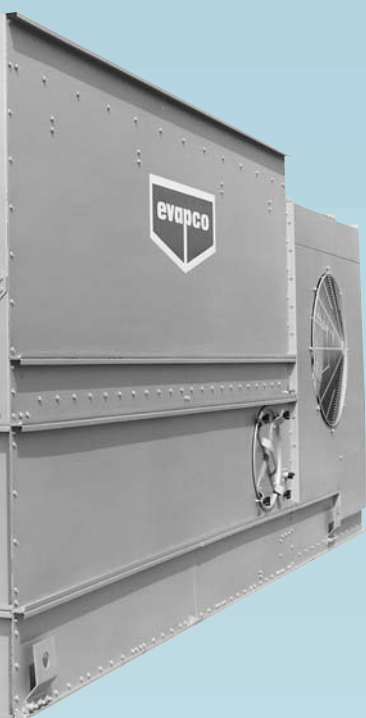

LRC Design features include:

- Low Silhouette
- Low Maintenance
- Low Rigging Costs
- Low Sound

PMCB Series

PMCB Models are forced draft, with axial flow fans and are available in capacities from 753 to 7620 kW. The effective axial flow fans can reduce power requirements by up to 50% over centrifugal fan models of similar capacity. Low energy consumption.

**For other EVAPCO
Condenser Models See:
ATC Series Induced Draft
Counterflow Design**



Since its founding in 1976, EVAPCO Inc. has become a world-wide leader in supplying quality equipment to the Industrial Refrigeration HVAC and Process Cooling Industries.

EVAPCO's success has been the result of a continual commitment to product improvement, quality workmanship and a dedication to providing unparalleled service.



An emphasis on research and development has lead to many product innovations – a hallmark of EVAPCO through the years.

The ongoing R & D Program enables EVAPCO to provide the most advanced products in the industry – technology for the future, available today.

With 16 facilities in seven countries and over 160 sales offices in 42 countries world-wide, EVAPCO is ready to assist in all your evaporative cooling needs.

Owner Advantages

Patented Thermal-Pak® Coil

EVAPCO's patented Thermal-Pak® condensing coils feature a design which assures maximum condensing capacity. The air-flow thru the coil is counterflow to the refrigerant flow, providing the most efficient heat transfer. This special coil design is utilized to reduce the air pressure drop through the unit while maximizing tube surface area and increasing its heat transfer capabilities. The uniquely shaped tubes of the coil are staggered in the direction of air flow to obtain a high film coefficient. In addition, all tubes are pitched in the direction of refrigerant flow to give good drainage of liquid refrigerant.

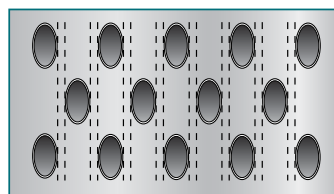

Thermal-Pak® Coil by EVAPCO

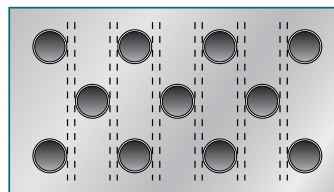

Round Tube Coil by Others

The coils are manufactured from high quality steel tubing following the most stringent quality control procedures. Each circuit is inspected to assure the material quality and then tested before being assemble into a coil. Finally, the assembled coil is air pressure tested under water in accordance with the "Pressure Equipment Directive" (PED) 97/23/EC.

To protect the coil against corrosion, it is placed in a heavy-duty steel frame and the entire assembly is dipped in molten zinc (hot dip galvanized) at a temperature of approximately 430°C).

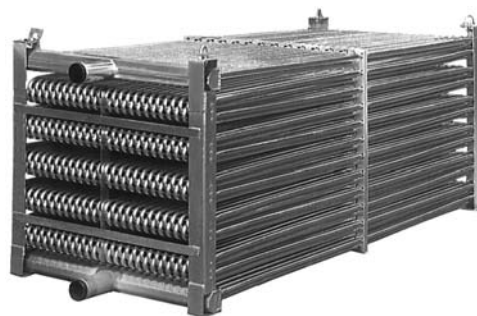

Thermal-Pak® Coil

U.S. Patent No. 4,500,330

EVAPCOAT Corrosion Protection System: The Standard for Evaporative Condensers

EVAPCO, long known for using premium materials of construction, has developed the ultimate system for corrosion protection in galvanized steel construction – the EVAPCOAT Corrosion Protection System. Marrying corrosion free materials with heavy gauge mill hot-dip galvanized steel construction to provide the longest life product with the best value.

Z-725 Mill Hot-Dip Galvanized Steel Construction

Mill hot-dip galvanized steel has been successfully used for over 25 years for the protection of evaporative condensers against corrosion. There are various grades of mill galvanized steel each with differing amounts of zinc protection. EVAPCO has been a leader in the industry in developing heavier galvanizing, and was the first to standardize on Z-725 mill hot-dip galvanized steel.

Z-725 designation means there is a minimum of 725 g of zinc per sqm of surface area as measured in a triple spot test. Z-725 is the heaviest level of galvanizing available for manufacturing evaporative condensers and has a minimum of 165% more zinc protection than competitive designs using Z-275 steel.

During fabrication, all panel edges are coated with a 95% pure zinc-rich compound for extended corrosion resistance.

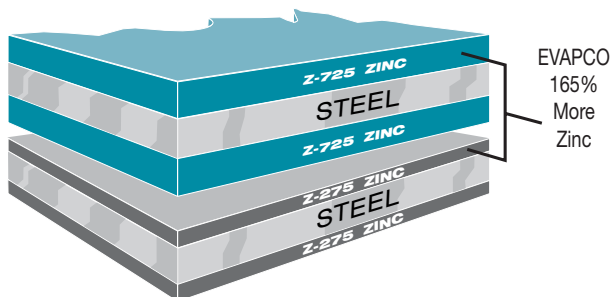

Type 304 Stainless Steel Strainers

Subjected to excessive wear and corrosion, the sump strainer is critical to the successful operation of the condenser. EVAPCO uses only stainless steel for this very important component.

PVC Drift Eliminators

The final elements in the upper part of the condenser are moisture eliminators which strip the entrained water droplets from the leaving air stream.

EVAPCO eliminators are constructed entirely of inert, corrosion-free PVC. This PVC material has been specially treated to resist damaging ultraviolet light. The eliminators are assembled in easily handled sections to facilitate removal thereby exposing the upper portion of the unit and water distribution system for periodic inspection.

PVC Water Distribution System

Another important part of an evaporative condenser is the water distribution system. In order to give the maximum heat transfer and minimize scaling, the coil must be drenched with water at all times. The EVAPCO system does this by circulating approximately 4 l/s over every square meter of coil surface area.

The water distribution system is greatly simplified in EVAPCO units, with the largest non-clog ZM water diffusers available for evaporative condensers. The ZM diffusers are threaded into the water distribution header to ensure correct positioning. Also, a collar on the diffuser extends into the header and acts as an anti-sludge ring to reduce the need for maintenance. Excellent flooding of the coil is maintained at all times without numerous small orifice nozzles. For corrosion protection the ZM diffusers are made of heavy-duty, glass reinforced nylon for long life and 100% corrosion resistance. Distributor pipes are non-corrosive Polyvinyl Chloride (PVC).



ZM Spray Nozzle

Totally Enclosed Motors

EVAPCO uses totally enclosed motors for all fan and pump motors as standard. These superior motors help to assure longer equipment life without motor failures, which result in costly downtime.

Alternate Materials of Construction

For particularly corrosive environments, EVAPCO condensers are available with Type 304 Stainless Steel construction for basins and/or casings. Model LR condensers are provided with type 304 stainless steel basins as standard equipment. Contact the factory for details on available options.



LSCB & LRC Design and Construction Features

The LSCB and LRC units are a result of EVAPCO's extensive experience in forced draft centrifugal fan designs. Both models are designed for easy maintenance and long, trouble free operation.

Efficient Drift Eliminators

- Advanced design removes mist from leaving airstream.
- Corrosion resistant PVC for long life.

Exclusive Thermal-Pak® Coil

- Providing Maximum Efficiency per Plan Area

Double-Brake Flange Joints

- Stronger than single-brake designs by others.
- Minimizes water leaks at field joints.
- Greater structural integrity.

Z-725 Heavy Mill-Dip Galvanized Steel Construction

- (Stainless steel available as affordable option)

Totally Enclosed Pump Motors

- Long, trouble-free operation.

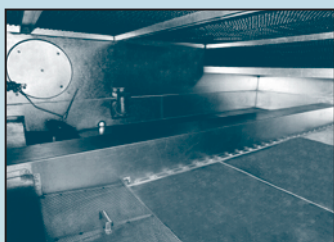

Stainless Steel Strainers

- Resists corrosion better than other materials.

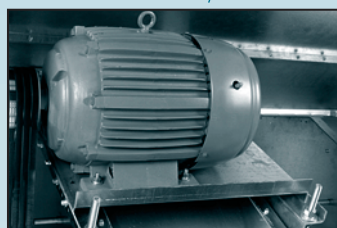

Totally Enclosed Fan Motors

- Assures long life
- All normal maintenance can be performed quickly from outside the unit.
- If required, motor may be easily removed.



The superior design offers:

- Low Rigging Costs • Low Installed Costs
- Low Silhouette • Low Maintenance • Low Sound

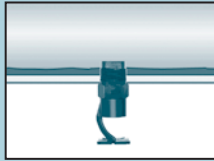

PVC Spray Distribution Header with ZM Nozzles

- Nozzles are threaded to assure proper orientation.
- "Anti-Sludge Ring" reduces maintenance.
- Large orifice nozzles prevent clogging.
- Threaded end caps for ease of cleaning.

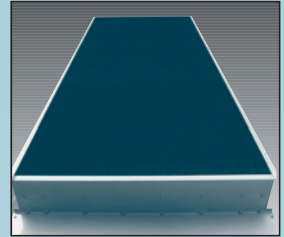
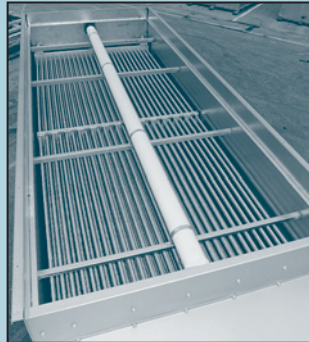
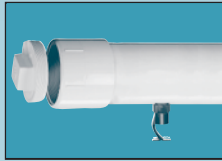

Efficient Drift Eliminators

- Advanced design removes mist from leaving airstream.
- Corrosion resistant PVC for long life.

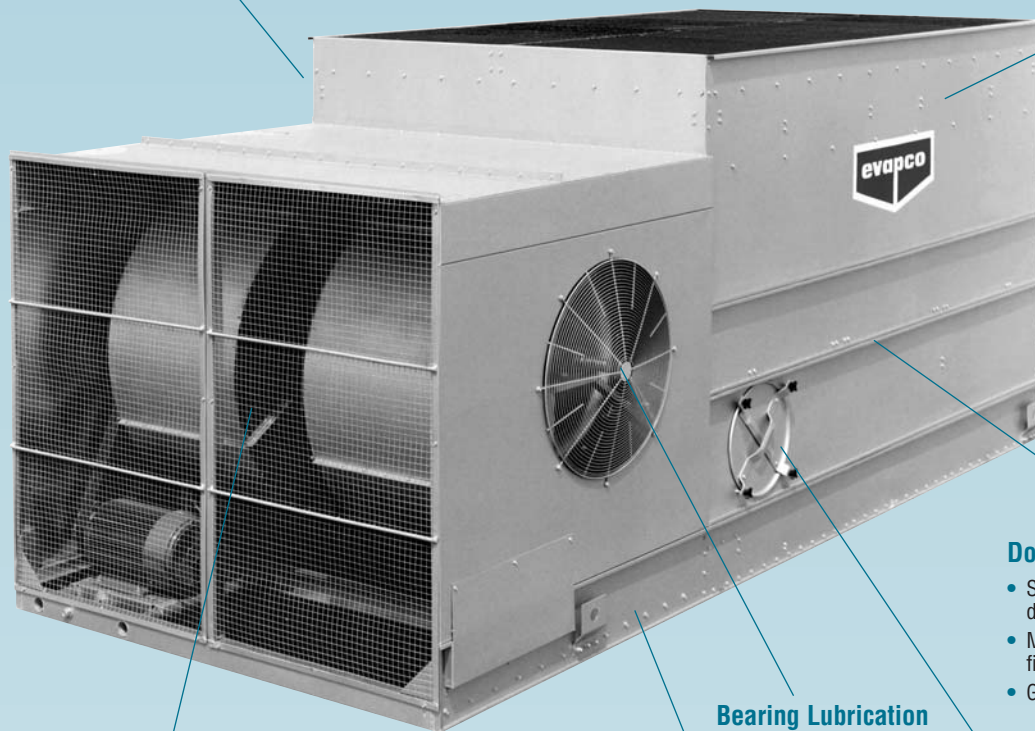

Z-725 Heavy Mill-Dip Galvanized Steel Construction

(Stainless steel available as affordable option)

Double-Brake Flange Joints

- Stronger than single-brake designs by others.
- Minimizes water leaks at field joints.
- Greater structural integrity.

Bearing Lubrication

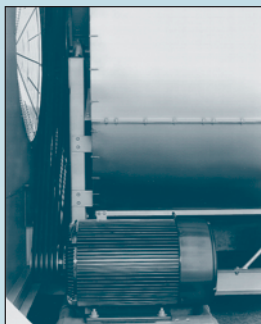

Easy to Service Motor Mount Design

- All normal maintenance can be performed quickly from outside the unit.
- If required, motor may be easily removed.
- Split fan housings allow removal of all mechanical equipment through the end of the unit.

Stainless Steel Basin

- Standard Construction
- Eliminates the need for unreliable epoxy coatings.

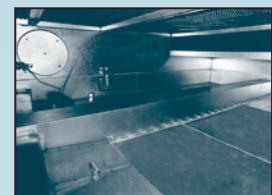

Stainless Steel Strainers

- Resists corrosion better than other materials.

Forced Draft Centrifugal Design Features LSCB & LRC Models

Application versatility

Centrifugal units are recommended for a wide range of installations. They are quiet, can easily be hidden, and the increase in fan motor kW over propeller fan units is generally not significant in the small size range. They are also excellent for larger installations where very quiet operation is a must, such as residential neighborhoods.

In addition, centrifugal fan units can operate against the static pressure loss of ductwork and are therefore ideal for indoor installations.

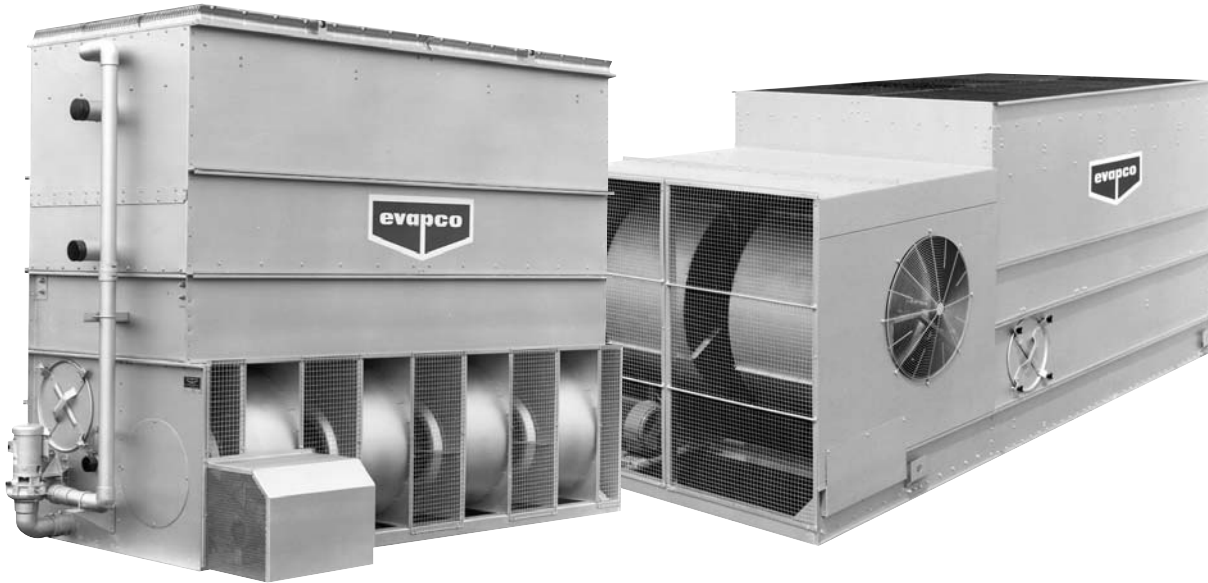

Centrifugal Fan Assembly

Fans on LSCB & LRC condensers are of the forward curved centrifugal design with hot-dip galvanized steel construction. All fans are statically and dynamically balanced and are mounted in a hot-dip galvanized steel housing designed and manufactured by EVAPCO.

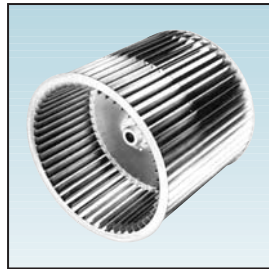

Centrifugal Fan

Very Quiet Operation

Centrifugal fan units operate at lower sound levels which make this design preferred for installations where noise is a concern. The sound they produce is primarily at high frequencies which is easily attenuated by building walls, windows, and natural barriers. Additionally, since the sound from the fans is directional, single sided air entry models can be turned away from critical areas avoiding a sound problem. When even quieter operation is necessary, centrifugal fan models can be equipped with optional sound attenuation packages. Consult the factory for details.

Capacity Control Dampers

Capacity control dampers are an excellent way to match unit capacity to system requirements. This option consists of dampers mounted in the air stream which modulate the air flow through the unit. They may also be supplied with an electric control package.

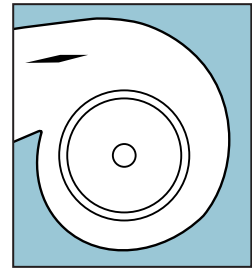

Fan Dampers

Fan Motor Mount

Fan motors are mounted in a convenient open area to make it easy to adjust belt tension, lubricate the motor, electrically connect it, or change the motor if necessary. The fan motor and drive are under a protective cover for safety and to protect them from the elements.

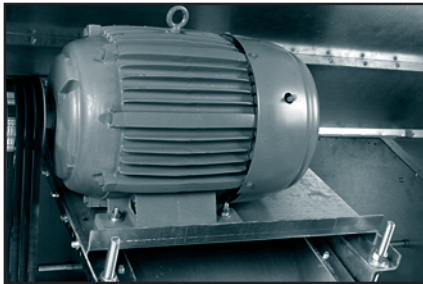

LSCB Fan Motor Mount

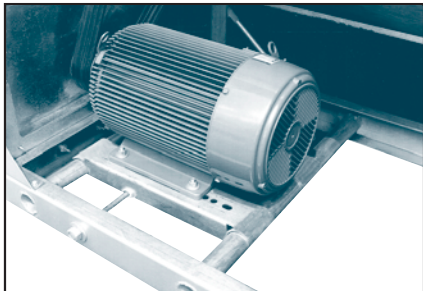

LRC Fan Motor Mount

Accessibility

The basin/fan section of a centrifugal fan unit is designed for accessibility and ease of maintenance. Fan and drive components are positioned to allow easy adjustment and cleaning. All grease fittings are in convenient locations for periodic lubrication.

Large circular access doors are provided on each section to allow entry into the basin. All float valve and strainer assemblies are located near the door for easy adjustment and cleaning. The basin sump is designed to catch the dirt accumulated and can be flushed out simply with a hose. The basin strainers may be easily removed for periodic cleaning.

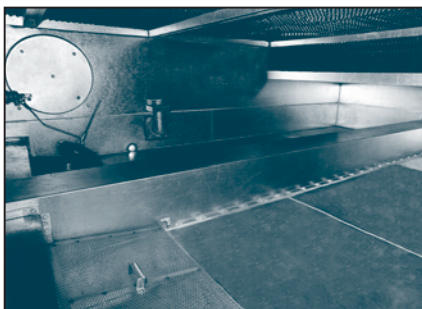

Reduced Height and Improved Maintenance Accessibility

The LRC unit has been designed to satisfy installation requirements where height limits must be observed. The lower profile design of the LRC does not, however, sacrifice maintenance accessibility for reduced height. Its unique casing design allows the water distribution system, cold water basin, fan section and other unit components to be easily maintained.

Small, light weight sections of the drift eliminators can be easily removed to access the water distribution system. Large circular access doors are located on both sides of the cold water basin to allow adjustment of the float assembly, removal of the stainless steel strainers and cleaning of the basin. The fan motor and drive system are located at one end of the unit and are completely accessible by removing the inlet screens. Although, routine maintenance can be performed from the exterior of the unit without removing the inlet screens

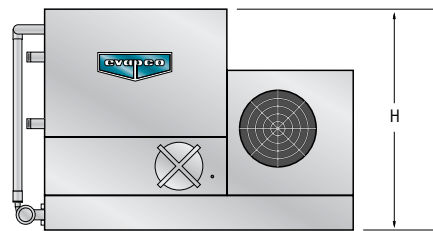

Low Installed Costs

The compact, unitary design of the LRC units allows them to be shipped completely assembled. This results in lower transportation costs and no assembly requirements at the job site. Note: Options such as sound attenuation and discharge hoods will require additional lifts and some minor assembly.

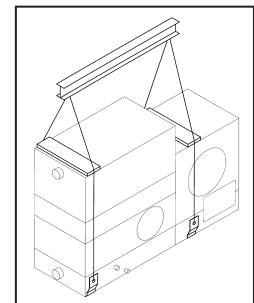

Transport of a Pre-Assembled Unit

The LRC ships fully assembled. This means lower transport costs and no further expenses at the job site for assembly. LRC units are ideal for truck-mounted applications for remote sites or temporary installations.

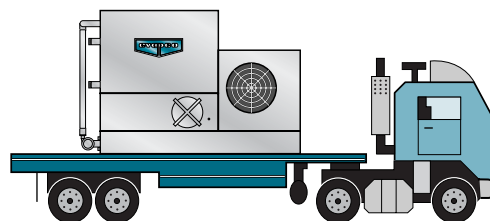

Forced Draft Axial Fan Design Features - PMCB Models

Energy Efficient for Lowest Operating Cost

Cut Operating kW up to 50%

The Power-Mizer models use effective axial flow fans which can reduce power requirements by up to 50%. This results in significant energy savings.



Vane Axial Fan Assembly

The PMCB models utilize two stage vane-axial fans for highly efficient operation. The fans are installed in a closely fitted cowl with a venturi inlet and advanced design guide vanes between stages, which help direct the flow and increase efficiency.

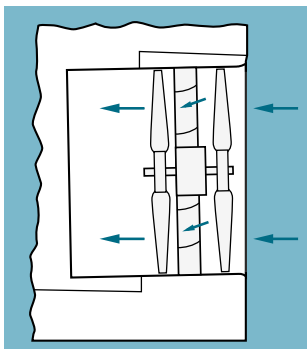

Two Stage Fan

Cast Aluminum Alloy Fans

The fans are heavy-duty cast aluminum alloy that are virtually corrosion free.

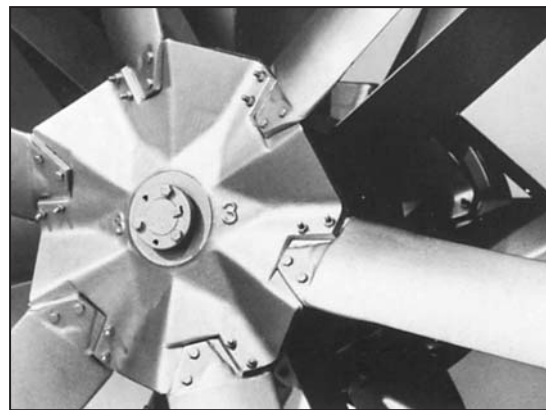

Vane-Axial Fan

PMCB Fan Motor Mount

EVAPCO's tandem TEFC motor mount assembly allows for two fans to be operated with one motor for simplicity. Routine maintenance is easily performed. If redundancy is a concern, individual fan motor drives are available as an option on PMCB models.

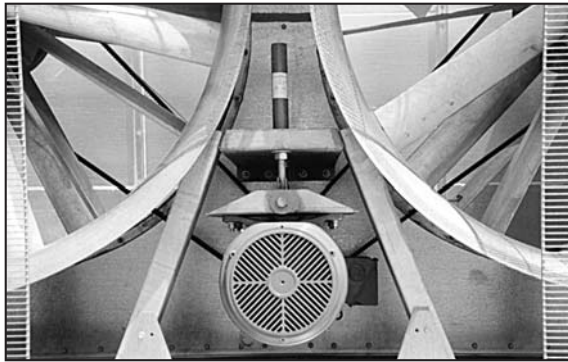

Tandem Fan Drive Motor Mount

Accessibility

The fan section is completely open and accessible at waist level where each part may be carefully checked by simply removing the safety screens.

Bearing grease fittings are extended to the outside of the unit to ease of lubrication.

The basin is also open and easy to access for inspection or cleaning. There is a depressed sump area to catch the dirt accumulated and it may be easily flushed out with a hose through the access door on either end.



Vane-Axial Fan

Internal Baffles

As a standard feature, all EVAPCO condensers with multiple motors are provided with an internal baffle system which extends from the pan bottom vertically through the coil bundle. This allows the user to cycle fan motors independently to match system load without the harmful effects of air by-pass.

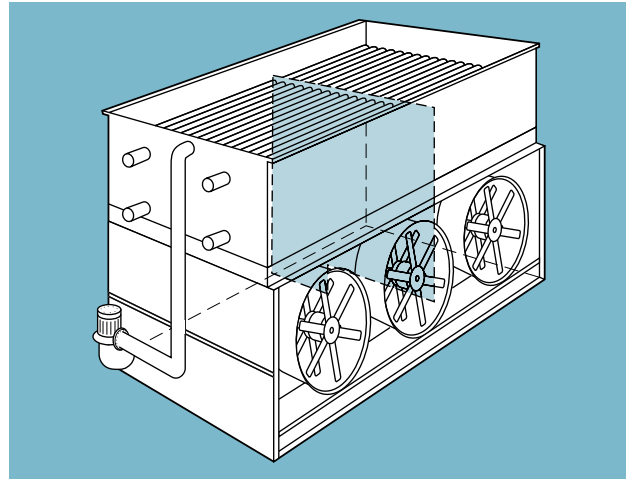

Internal Baffles

Power-Band Drive

The Power-Band drive is a solid backed belt system that has a high lateral rigidity. This eliminates the problem of mismatched belts and prevents belts from jumping pulleys, a common problem with other designs.

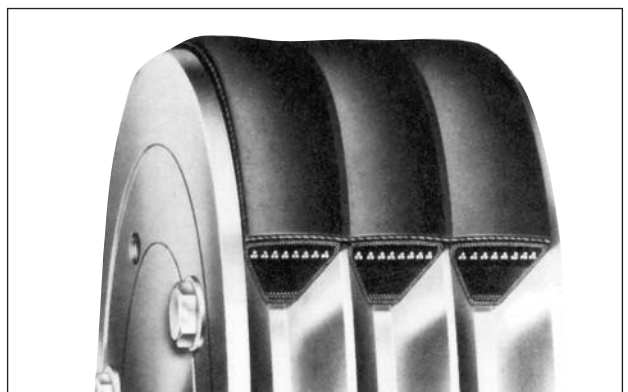

Power-Band

Optional Equipment for Evaporative Condensers

Two Speed Motors

Two speed fan motors can provide an excellent means of capacity control. In periods of lightened loads or reduced wet bulb temperatures, the fans can operate at low speed, which will provide about 60% of full speed capacity, yet consume only about 15% of the power compared with high speed. In addition to the energy savings, the sound levels of the units will be greatly reduced at low speed.

LSCB & LRC Models

Capacity Control Dampers & Pony Motors

In addition to two speed fan motors, variable frequency drives (VFD's) or cycling fan motor on multiple motor units, centrifugal fan condensers have two other types of capacity control options available to them: Pony motors and capacity control fan dampers.

Pony motors utilize a smaller fan motor in conjunction with the primary motor for use in times of reduced loading.

This pony motor is typically 1/4 the kW of the primary motor, and can significantly reduce energy requirements.

Capacity control fan dampers are located directly in the fan housings. They control head pressure by modulating the air flow through the unit to match the capacity of the condenser to the system load.

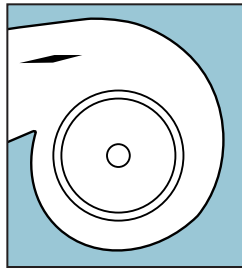

Fan Dampers

Basin Heater Package

If a remote sump configuration is not practical, electric basin heater packages are available to help prevent freeze-up of the basin water. The packages include electric heater elements and a combination with thermostat and low water cutoff. (See page 25 for heater size and application)

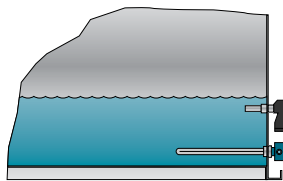

Electric Water Level Control

EVAPCO evaporative condensers are available with an optional electric water level control system in place of the standard mechanical makeup valve and float assembly. This package provides very accurate control of the pan water level and does not require field adjustment, even under widely variable operating conditions.

The control was designed by EVAPCO and consists of multiple heavy duty stainless steel electrodes. These electrodes are mounted external to the unit.

The weather protected slow closing solenoid valve for the makeup water connection is factory supplied and is ready for piping to a water supply with a pressure between 140 kPa (minimum) and 340 kPa (maximum).

Multiple Circuit Coils

Condensers may be supplied with multiple circuit coils to match various system requirements such as split systems, or if a glycol or water circuit is desired for compressor head cooling.

Extended Surface Coil

Condensers can be provided with spiral fins on the heat exchanger coil to increase the dry performance of the unit. Dry performance is accomplished by rejecting heat to the atmosphere without the use of the spray pump and the evaporation process. Dry operation can be practical in cold climates and/or when reduced winter loads exist. The number of fins per inch and quantity of rows finned can be varied to obtain different dry performances. Dry operation often requires the next larger size fan motor. Consult the factory for sizing.

Sub-Cooling Coils

EVAPCO's standard subcooling coil is designed to provide 5.5°C of refrigerant liquid subcooling on halocarbon refrigerants. The subcooling coil section is mounted between the condensing coil and the pan section.

Solid Bottom Panels for Ductwork

When centrifugal fan units are installed indoors and intake air is ducted to the unit, a solid bottom panel is required to completely enclose the fan section and prevent the unit from drawing room air into the fan intakes. When this is ordered, air inlet screens are omitted and the fan bearings are provided with extended lubrication fittings to facilitate maintenance from outside the duct.

Access Ladders

Access ladders are available to provide access for water distribution system inspection and maintenance.

Stainless Steel Basin (Option)

LSCA and PMCB condensers are available with an inexpensive all stainless steel basin section. This provides superior corrosion resistance over other materials of construction. (Standard on all LRC models)

Optional Equipment for Sound Reduction

LSCB & LRC Models

Sound Attenuation Packages

The centrifugal fan design of the LSCB and LRC models operate at lower sound level which make these units preferred for installations where noise is a concern. The sound they produce is primarily at high frequencies which is easily attenuated by building walls, windows and natural barriers. For extremely noise sensitive applications, the LSCB and LRC centrifugal fan models may be supplied with various stages of intake and/or discharge attenuation packages which greatly reduce sound levels.

The sound attenuation options can be provided in stages to provide varying degrees of attenuation while economically matching the project sound requirements.

Oversize fan motors are required for many of these options in order to overcome the additional static pressure. Consult the factory for Certified Sound Data for each sound attenuation option.

Fan Side Inlet Attenuation (*LRC only*)

Reduces sound radiated from the fan side air intakes and has an open bottom to allow for air entry. This attenuation package ships loose to be mounted in the field on each side of the cooling tower over the fan intakes.

Fan End Inlet Attenuation (*LSCB and LRC*)

Reduces sound radiated through the end air intakes. It consists of baffled panels to change the path of the air entry and to capture the radiated noise thus reducing the overall sound levels generated. In addition, the external belt adjustment mechanism is extended through the inlet attenuator to allow easy belt adjustment without having to enter the unit.

Discharge Attenuation (*LSCB and LRC*)

The discharge attenuation hood features a straight sided design with insulated baffles to reduce the overall sound levels of the discharge air. The discharge attenuation incorporates a large access panel to allow entry to the drift eliminators and water distribution system. If a higher discharge velocity is required with minimal sound attenuation, a tapered discharge hood is available.

PMCB Models

Wide Blade Fans

Wide blade fans are available for PMCB forced draft units. The cast aluminum fans operate at lower tip speeds to significantly reduce sound levels.

Discharge Attenuation

(*LSCB and LRC*)

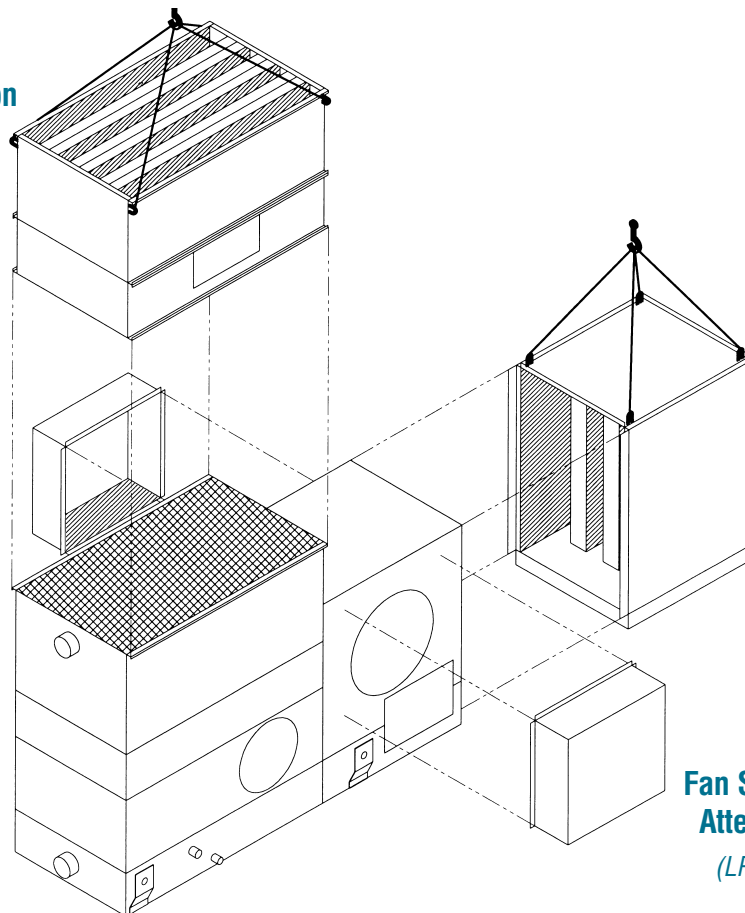

Fan End Inlet Attenuation

(*LSCB and LRC*)

Fan Side Inlet Attenuation

(*LRC only*)



Selection Procedure

The following selection procedure is applicable to both reciprocating and screw compressors. (Refer to factory for selection on centrifugal compressors.) The total heat of rejection for the system is determined by adding the evaporator load, expressed in kW, and the absorbed kW of the compressor motor. This procedure applies to both open type and hermetic compressors.

Once the heat of rejection has been determined, multiply it by the factor for the specified operating conditions (condensing temperature and wet bulb temperature) obtained from either Table 1 or Table 2. The resultant figure is then used to select a unit from Table 3.

EXAMPLE

Given: 1000 kW Evaporator Load, Ammonia Refrigerant at 36°C Condensing Temperature, 24°C Wet Bulb Temperature with a 300 kW Compressor.

Selection: Evaporator Load = 1000 kW
 Compressor Load = 300 kW
 Total = 1300 kW
 Heat of Rejection

From Table 2, the Capacity Factor for 36°C Condensing Temperature and 24°C Wet Bulb temperature = 1,20

$$\begin{array}{rcl} 1300 & & 1,20 & & 1560 \\ \text{(Total Heat of Rejection)} & \times & \text{(Capacity Factor)} & = & \text{(Corrected Heat Rejection Load)} \end{array}$$

Therefore, from Table 3 select LSCB-370, or LRC-379, or PMCB 375, or PMCB 385 depending upon layout, fan kW, and any other design considerations.

Note:

For screw compressor selections employing water cooled oil cooling, select a condenser for the total kW as in the example. The condenser can then function in one of two ways:

(1) Recirculating water from the water sump can be used directly in the oil cooler. A separate pump should be employed and the return water should be directed into the water sump at the opposite end from the pump suction.

(2) The condenser coil can be circuited so that water or a glycol-water mixture for the oil cooler can be cooled in a separate section of the coil. Specify load and water flow required.

For refrigerant injection cooled screw compressors select the condenser in the same manner as shown in the example.

If the oil cooler is supplied by water from a separate source, then the oil cooling load should be deducted from the heat of rejection before making the selection.

TABLE 1 R-22 and R-134a Heat Rejection Factors

Condensing Pressure, (KPa)	Cond. Temp. °C	WET BULB TEMPERATURE, °C.																		
		10	12	14	16	17	18	19	20	21	22	23	24	25	26	27	28	29	30	
22	134-a																			
1090	669	30	1,07	1,15	1,25	1,38	1,47	1,57	1,69	1,83	2,00	2,23	2,50	2,86	3,36	—	—	—	—	—
1154	718	32	0,94	1,01	1,09	1,19	1,26	1,32	1,40	1,49	1,60	1,74	1,90	2,11	2,36	—	—	—	—	—
1220	759	34	0,85	0,90	0,97	1,04	1,09	1,14	1,20	1,26	1,34	1,43	1,54	1,66	1,81	2,02	2,31	—	—	—
1253	785	35	0,80	0,85	0,91	0,97	1,02	1,06	1,11	1,15	1,21	1,29	1,37	1,46	1,56	1,71	1,89	2,13	2,41	2,77
1287	814	36	0,77	0,81	0,86	0,92	0,96	1,00	1,04	1,07	1,13	1,19	1,26	1,34	1,43	1,56	1,71	1,90	2,14	2,43
1359	856	38	0,70	0,74	0,78	0,82	0,85	0,88	0,90	0,93	0,96	1,01	1,06	1,11	1,18	1,26	1,35	1,47	1,62	1,78
1431	915	40	0,65	0,67	0,70	0,73	0,76	0,78	0,80	0,83	0,86	0,89	0,93	0,97	1,02	1,08	1,14	1,22	1,32	1,44
1508	978	42	0,59	0,62	0,64	0,67	0,68	0,70	0,72	0,74	0,77	0,80	0,83	0,86	0,89	0,94	0,98	1,04	1,11	1,19
1587	1026	44	0,54	0,56	0,59	0,61	0,62	0,63	0,65	0,66	0,68	0,70	0,73	0,75	0,78	0,82	0,85	0,89	0,92	0,97

TABLE 2 Ammonia (R-717) Heat Rejection Factors

Condensing Pressure, (KPa)	Cond. Temp. °C	WET BULB TEMPERATURE, °C.																		
		10	12	14	16	17	18	19	20	21	22	23	24	25	26	27	28	29	30	
1063	30	0,95	1,03	1,12	1,23	1,31	1,40	1,51	1,63	1,79	1,99	2,24	2,56	3,00	—	—	—	—	—	—
1133	32	0,84	0,90	0,97	1,06	1,12	1,18	1,25	1,32	1,43	1,55	1,70	1,88	2,11	—	—	—	—	—	—
1206	34	0,76	0,81	0,86	0,93	0,98	1,02	1,07	1,12	1,19	1,28	1,38	1,48	1,61	1,80	2,06	—	—	—	—
1245	35	0,71	0,76	0,81	0,87	0,91	0,95	0,99	1,03	1,08	1,15	1,23	1,30	1,39	1,53	1,69	1,90	2,15	2,47	—
1284	36	0,69	0,73	0,77	0,82	0,86	0,89	0,92	0,96	1,01	1,07	1,13	1,20	1,28	1,39	1,53	1,70	1,91	2,17	—
1365	38	0,63	0,66	0,69	0,73	0,76	0,78	0,81	0,83	0,86	0,90	0,94	0,99	1,05	1,12	1,21	1,31	1,44	1,59	—
1451	40	0,58	0,60	0,62	0,65	0,67	0,70	0,72	0,74	0,76	0,80	0,83	0,87	0,91	0,96	1,02	1,09	1,18	1,29	—
1539	42	0,53	0,55	0,57	0,60	0,61	0,63	0,64	0,66	0,68	0,71	0,74	0,76	0,80	0,84	0,88	0,93	0,99	1,06	—
1630	44	0,49	0,50	0,52	0,54	0,56	0,56	0,58	0,59	0,61	0,63	0,65	0,67	0,70	0,73	0,76	0,79	0,83	0,86	—

TABLE 3 Unit Heat Rejection Capacity

LSCB - Centrifugal Fan Models									
Model No.	kW Base	Model No.	kW Base	Model No.	kW Base	Model No.	kW Base	Model No.	kW Base
LSCB-36	155	LSCB-210	904	LSCB-400	1722	LSCB-620	2669	LSCB-950	4090
41	177	225	969	410	1766	625	2691	960	4133
48	207	240	1033	430	1851	650	2798	980	4219
54	232	250	1076	431	1855	660	2841	1000	4305
65	280	280	1205	450	1937	690	2970	1020	4391
70	301	281	1206	460	1980	691	2972	1030	4434
75	323	295	1270	475	2045	720	3100	1060	4563
80	344	300	1292	480	2066	721	3102	1080	4649
90	387	310	1335	490	2109	755	3250	1100	4736
100	431	315	1356	500	2153	770	3315	1120	4822
110	474	330	1421	510	2196	800	3444	1180	5080
120	517	335	1442	515	2217	805	3466	1250	5381
135	581	345	1485	530	2282	820	3532	1310	5640
150	646	355	1528	540	2325	860	3702	1380	5941
155	667	360	1550	550	2368	861	3704	1440	6199
170	732	370	1593	560	2411	900	3875	1510	6501
185	796	385	1657	590	2540	920	3961	1610	6931
200	861	386	1662	591	2544				

LRC - Centrifugal Fan Models									
Model No.	kW Base	Model No.	kW Base	Model No.	kW Base	Model No.	kW Base	Model No.	kW Base
LRC - 25	108	LRC - 65	280	LRC - 128	551	LRC - 225	969	LRC - 249	1072
27	116	72	310	131	564	233	1003	287	1236
29	125	76	327	140	603	246	1059	300	1292
35	151	84	362	155	667	188	809	321	1382
38	164	91	392	174	749	211	908	336	1446
42	181	101	435	183	788	227	977	361	1554
48	207	114	491	190	818	240	1033	379	1632
51	220	108	465	201	865	255	1098		
58	250	116	500	213	917	269	1158		

Power-Mizer Models									
Model No.	kW Base	Model No.	kW Base	Model No.	kW Base	Model No.	kW Base	Model No.	kW Base
PMCB-190	818	PMCB-360	1550	PMCB-580	2497	PMCB-885	3810	PMCB-1380	5941
210	904	375	1614	600	2583	960	4133	1410	6070
220	947	390	1679	630	2712	1000	4305	1485	6393
235	1012	415	1787	660	2841	1015	4370	1540	6630
240	1033	435	1873	690	2970	1030	4434	1630	7017
250	1076	455	1959	725	3121	1080	4649	1710	7362
275	1184	480	2066	755	3250	1120	4822	1770	7620
295	1270	510	2196	775	3336	1175	5058		
325	1399	535	2303	815	3509	1260	5424		
350	1507	560	2411	855	3681	1320	5683		

Alternate Power-Mizer Models*									
Model No.	kW Base	Model No.	kW Base	Model No.	kW Base	Model No.	kW Base	Model No.	kW Base
PMCB-175	753	PMCB-425	1830	PMCB-585	2518	PMCB-805	3466	PMCB-1060	4563
290	1248	450	1937	645	2777	850	3659	1110	4779
330	1421	475	2045	705	3035	910	3918	1510	6501
335	1442	495	2131	770	3315	950	4090	1550	6673
385	1657	540	2325						

Unit Selections

Selections for all evaporative condensers can be made by using EVAPCO's IES computer selection software. IES provides quick and accurate selections at the click of a button. In addition to selections, the program displays unit drawings, dimensional and shipping information. Please contact your local sales representative or visit the EVAPCO Europe web.

NOTE: For applications requiring layout or fan kW combinations not shown above, please consult the factory or your EVAPCO representative.

* Alternate Power-Mizer models represent selections for alternate plan area or low fan kW applications. Standard models should be used for the lowest first-cost selection.

Low Silhouette Evaporative Condenser Centrifugal Fan Models LRC 25 to 246

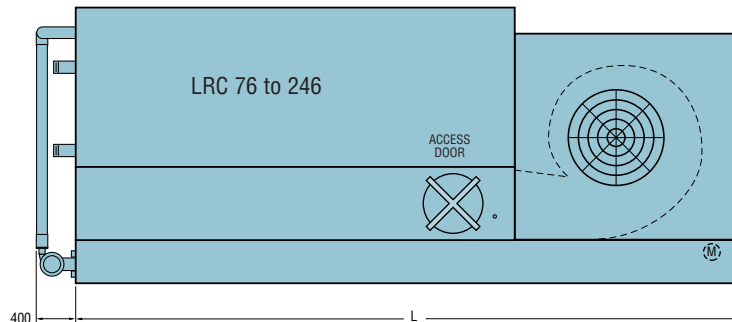
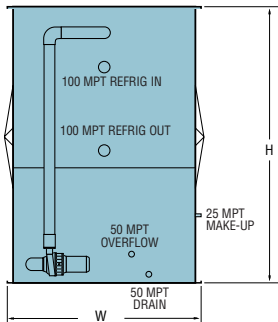
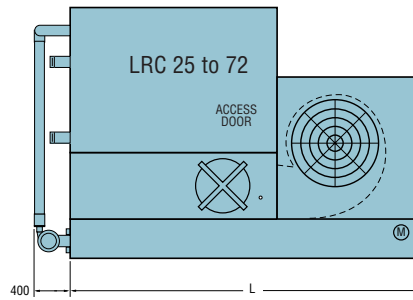
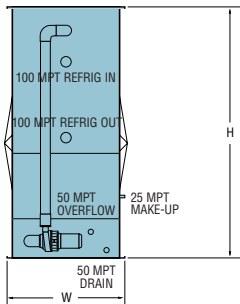

TABLE 4 Engineering Data

UNIT NO.	FANS			WEIGHTS (kg)		** R-717 Operating Charge (kg)	SPRAY PUMP		REMOTE SUMP		DIMENSIONS (mm)		
	N°	kW*	m ³ /s	Shipping	Operating		kW	l/s	Liters Req'd***	Conn. Size	HEIGHT H	LENGTH L	WIDHT W
LRC- 25	1	0,75	3,1	1050	1520	19	0,37	6,3	303	100	2026	3083	1029
27	1	1,1	3,6	1050	1525	19	0,37	6,3	303	100	2026	3083	1029
29	1	1,5	3,9	1050	1525	19	0,37	6,3	303	100	2026	3083	1029
35	1	1,1	3,5	1200	1685	27	0,37	6,3	303	100	2026	3083	1029
38	1	1,5	3,9	1200	1685	27	0,37	6,3	303	100	2026	3083	1029
42	1	2,2	4,4	1205	1690	27	0,37	6,3	303	100	2026	3083	1029
48	1	4	5,2	1210	1695	27	0,37	6,3	303	100	2026	3083	1029
51	1	2,2	4,3	1365	1860	34	0,37	6,3	303	100	2216	3083	1029
58	1	4	5,1	1370	1865	34	0,37	6,3	303	100	2216	3083	1029
65	1	4	5,0	1540	2050	42	0,37	6,3	303	100	2407	3083	1029
72	1	5,5	5,8	1565	2070	42	0,37	6,3	303	100	2407	3083	1029
LRC-76	1	4	7,6	1835	2680	43	0,75	10	455	150	2026	3731	1540
84	1	5,5	8,7	1850	2700	43	0,75	10	455	150	2026	3731	1540
91	1	4	7,4	2075	2945	55	0,75	10	455	150	2216	3731	1540
101	1	5,5	8,5	2120	2985	55	0,75	10	455	150	2216	3731	1540
114	1	5,5	8,3	2365	3250	67	0,75	10	455	150	2407	3731	1540
LRC-108	1	5,5	10,6	2380	3660	61	1,1	16	643	150	2026	4636	1540
116	1	7,5	11,7	2400	3675	61	1,1	16	643	150	2026	4636	1540
128	1	11	13,3	2450	3725	61	1,1	16	643	150	2026	4636	1540
131	1	5,5	10,4	2760	4065	79	1,1	16	643	150	2216	4636	1540
140	1	7,5	11,4	2770	4080	79	1,1	16	643	150	2216	4636	1540
155	1	11	13,1	2820	4130	79	1,1	16	643	150	2216	4636	1540
174	1	11	12,8	3215	4550	99	1,1	16	643	150	2407	4636	1540
183	1	11	12,6	3555	4920	118	1,1	16	643	150	2597	4636	1540
LRC-190	1	15	16,2	3465	5250	106	1,5	21,8	908	200	2242	5553	1540
201	1	18,5	17,4	3470	5255	106	1,5	21,8	908	200	2242	5553	1540
213	1	15	15,8	3955	5780	132	1,5	21,8	908	200	2432	5553	1540
225	1	18,5	17,0	3965	5785	132	1,5	21,8	908	200	2432	5553	1540
233	1	22	18,1	3975	5790	132	1,5	21,8	908	200	2432	5553	1540
246	1	22	17,7	4430	6295	157	1,5	21,8	908	200	2623	5553	1540

* For dry operation or for external static pressure up to 125 Pa use next larger size fan motor.

** Refrigerant charge is shown for R-717. Multiply by 1.93 for R-22 and 1.98 for R-134a.

***Liters shown is water in suspension in unit and piping. Allow for additional water in bottom of remote sump to cover pump suction and strainer during operation. (300 mm would normally be sufficient.)

Engineering Dimensions & Data

Low Silhouette Evaporative Condenser Centrifugal Fan Models LRC 188 to 379

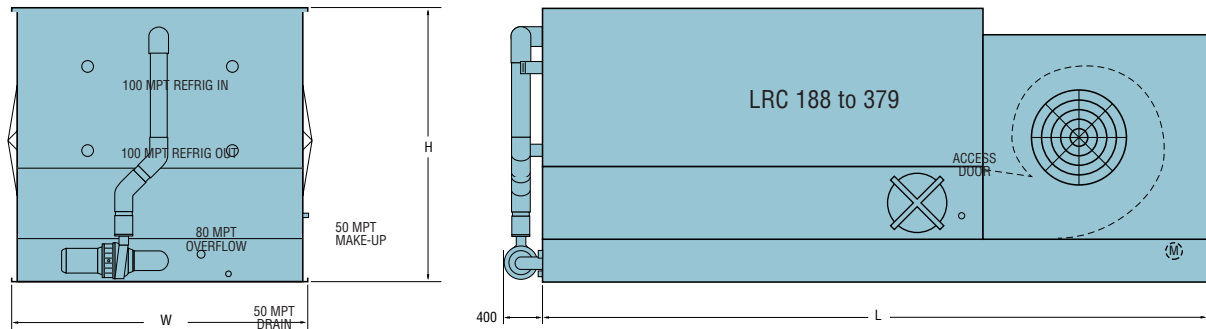

TABLE 5 Engineering Data

UNIT NO.	FANS			WEIGHTS (kg)		R-717 Operating Charge (kg)	SPRAY PUMP		REMOTE SUMP		DIMENSIONS (mm)		
	N°	kW*	m³/s	Shipping	Operating		kW	l/s	Liters Req'd***	Conn. Size	HEIGHT H	LENGTH L	WIDHT W
LRC-188	2	15	19,7	3680	5780	94	1,5	25,6	946	200	2121	4629	2388
211	2	11	17,6	4225	6370	119	1,5	25,6	946	200	2311	4629	2388
227	2	15	19,3	4230	6380	119	1,5	25,6	946	200	2311	4629	2388
240	2	18,5	20,8	4235	6380	119	1,5	25,6	946	200	2311	4629	2388
255	2	15	19,0	4920	7165	178	1,5	25,6	946	200	2502	4629	2388
269	2	18,5	20,4	4925	7170	178	1,5	25,6	946	200	2502	4629	2388
LRC-249	2	22	26,3	4410	7265	128	2,2	34,4	1363	250	2121	5553	2388
287	2	18,5	24,3	5110	8035	166	2,2	34,4	1363	250	2311	5553	2388
300	2	22	25,9	5125	8040	166	2,2	34,4	1363	250	2311	5553	2388
321	2	18,5	23,8	5865	8845	204	2,2	34,4	1363	250	2502	5553	2388
336	2	22	25,3	5875	8855	204	2,2	34,4	1363	250	2502	5553	2388
361	2	30	27,9	6010	8985	204	2,2	34,4	1363	250	2502	5553	2388
379	2	30	27,3	6715	9750	242	2,2	34,4	1363	250	2692	5553	2388

* For dry operation or for external static pressure up to 125 Pa use next larger size fan motor.

** Refrigerant charge is shown for R-717. Multiply by 1.93 for R-22 and 1.98 for R-134a.

***Liters shown is water in suspension in unit and piping. Allow for additional water in bottom of remote sump to cover pump suction and strainer during operation. (300 mm would normally be sufficient.)



Engineering Dimensions & Data *Centrifugal Fan Models LSCB 36 to 385*

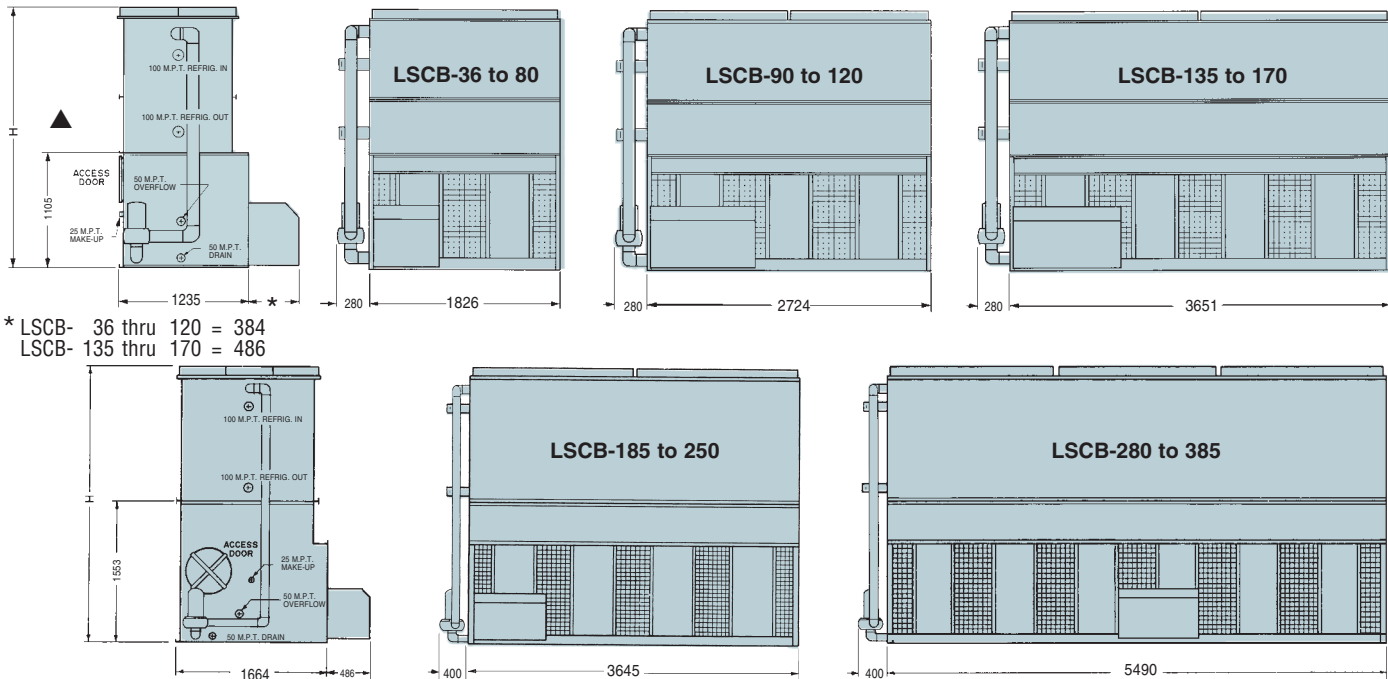

* LSCB- 36 thru 120 = 384
LSCB- 135 thru 170 = 486

▲ NOTE: Coil connection(s) and other unit dimensions may vary to match application requirements and/or shipping regulations. Consult the EVAPCO plant or certified drawings for detailed information.

TABLE 6 Engineering Data

UNIT NO.	FANS		WEIGHTS (KG)			R-717 Operating Charge	SPRAY PUMP		REMOTE SUMP		HEIGHT (mm)
	KW	m ³ /s	Shipping	Operating	Heaviest Section †		KW	l/s	Liters Req'd**	Conn. Size	
LSCB-36	2,2	4,8	1005	1440	1005*	17	0,55	7,6	303	100	2048
41	4,0	5,7	1035	1465	1035*	17	0,55	7,6	303	100	2048
48	2,2	4,7	1230	1610	1230*	26	0,55	7,6	303	100	2238
54	4,0	5,6	1265	1645	1265*	26	0,55	7,6	303	100	2238
65	4,0	5,5	1405	1795	925	35	0,55	7,6	303	100	2429
70	5,5	6,1	1445	1835	925	35	0,55	7,6	303	100	2429
75	4,0	5,4	1550	1950	1100	44	0,55	7,6	303	100	2619
80	5,5	6,0	1620	2020	1100	44	0,55	7,6	303	100	2619
LSCB-90	4,0	7,2	1985	2585	1360	52	0,75	11,4	454	150	2429
100	5,5	8,2	2050	2650	1360	52	0,75	11,4	454	150	2429
110	7,5	9,1	2110	2710	1360	52	0,75	11,4	454	150	2429
120	7,5	8,9	2290	2900	1630	65	0,75	11,4	454	150	2619
LSCB-135	7,5	11,2	2595	3440	1795	70	1,1	15,5	643	150	2429
150	11,0	12,6	2650	3495	1795	70	1,1	15,5	643	150	2429
155	7,5	11,0	2950	3815	2155	87	1,1	15,5	643	150	2619
170	11,0	12,3	3015	3885	2155	87	1,1	15,5	643	150	2619
LSCB-185	7,5	15,5	3590	4645	2480	100	1,5	21,8	871	200	2979
200	11,0	16,8	3655	4715	2480	100	1,5	21,8	871	200	2979
210	15,0	17,7	3715	4770	2480	100	1,5	21,8	871	200	2979
225	11,0	16,4	4115	5205	2985	125	1,5	21,8	871	200	3194
240	15,0	17,6	4175	5260	2985	125	1,5	21,8	871	200	3194
250	15,0	17,4	4630	5745	3495	150	1,5	21,8	871	200	3410
LSCB-280	11,0	22,3	5475	6865	3780	150	2,2	32,5	1287	200	2979
300	15,0	24,5	5535	6920	3780	150	2,2	32,5	1287	200	2979
315	18,5	26,2	5625	7015	3780	150	2,2	32,5	1287	200	2979
335	15,0	23,8	6245	7665	4530	186	2,2	32,5	1287	200	3194
355	18,5	25,6	6335	7755	4530	186	2,2	32,5	1287	200	3194
370	22,0	27,2	6405	7825	4530	186	2,2	32,5	1287	200	3194
385	22,0	26,7	7070	8530	5290	225	2,2	32,5	1287	200	3410

* Unit ships in one piece.

** Liters shown is water in suspension in unit and piping. Allow for additional water in bottom of remote sump to cover pump suction and strainer during operation. (300 mm would normally be sufficient.)

† Heaviest section is the coil section.

Refrigerant charge is shown for R-717. Multiply by 1,93 for R-22 and 1,98 for R-134a. Dimensions are subject to change. Do not use for pre-fabrication.

Centrifugal Fan Models LSCB 281 to 1120

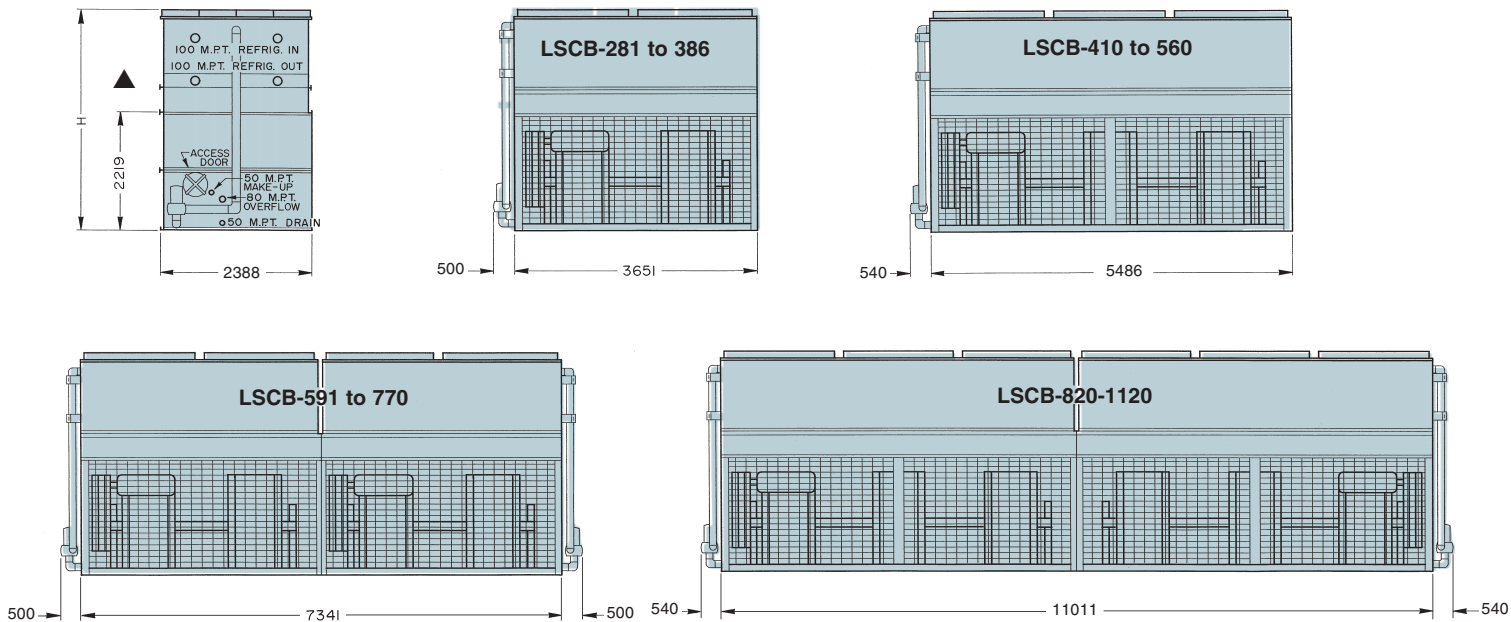

▲ NOTE: Coil connection(s) and other unit dimensions may vary to match application requirements and/or shipping regulations. Consult the EVAPCO plant or certified drawings for detailed information.

TABLE 7 Engineering Data

UNIT NO.	FANS		WEIGHTS (KG)			R-717 Operating Charge	SPRAY PUMP		REMOTE SUMP		HEIGHT (mm)
	kW	m ³ /s	Shipping	Operating	Heaviest Section†		kW	l/s	Liters Req'd**	Conn. Size	
LSCB-281	15	22.5	5580	7620	3990	153	4	36	1370	250	3549
295	18.5	24.2	5625	7710	3990	153	4	36	1370	250	3549
310	22	25.7	5670	7755	3990	153	4	36	1370	250	3549
330	18.5	23.8	6395	8530	4765	192	4	36	1370	250	3740
345	22	25.2	6440	8575	4765	192	4	36	1370	250	3740
360	22	24.7	7210	9435	5535	230	4	36	1370	250	3930
386	30	27.3	7255	9480	5535	230	4	36	1370	250	3930
LSCB-410	18.5	31.7	8165	11205	5895	230	5.5	53	2000	300	3549
431	22	33.7	8210	11250	5895	230	5.5	53	2000	300	3549
460	30	37	8255	11295	5895	230	5.5	53	2000	300	3549
475	22	33	9345	12520	7030	287	5.5	53	2000	300	3740
490	37	39.9	8300	11340	5895	230	5.5	53	2000	300	3549
510	30	36.6	9390	12565	7030	287	5.5	53	2000	300	3740
530	30	35.6	10525	13835	8210	345	5.5	53	2000	300	3930
540	37	39.3	9435	12610	7030	287	5.5	53	2000	300	3740
560	37	38.3	10570	13880	8210	345	5.5	53	2000	300	3930
LSCB-591	(2) 18.5	48.4	11250	15420	3990	307	(2) 4	72	2740	(2) 250	3549
620	(2) 22	51.4	11340	15510	3990	307	(2) 4	72	2740	(2) 250	3549
660	(2) 18.5	47.6	12790	17060	4765	383	(2) 4	72	2740	(2) 250	3740
691	(2) 22	50.4	12880	17150	4765	383	(2) 4	72	2740	(2) 250	3740
721	(2) 22	49.4	14420	18870	5535	460	(2) 4	72	2740	(2) 250	3930
770	(2) 30	54.6	14510	18960	5535	460	(2) 4	72	2740	(2) 250	3930
LSCB-820	(2) 18.5	63.4	16330	22410	5895	460	(2) 5.5	106	4000	(2) 300	3549
861	(2) 22	67.4	16420	22500	5895	460	(2) 5.5	106	4000	(2) 300	3549
920	(2) 30	74	16510	22590	5895	460	(2) 5.5	106	4000	(2) 300	3549
950	(2) 22	66	18690	25040	7030	575	(2) 5.5	106	4000	(2) 300	3740
980	(2) 37	79.8	16600	22680	5895	460	(2) 5.5	106	4000	(2) 300	3549
1020	(2) 30	73.2	18780	25130	7030	575	(2) 5.5	106	4000	(2) 300	3740
1060	(2) 30	71.2	21050	27770	8210	690	(2) 5.5	106	4000	(2) 300	3930
1080	(2) 37	78.6	18870	25220	7030	575	(2) 5.5	106	4000	(2) 300	3740
1120	(2) 37	76.6	21140	27860	8210	690	(2) 5.5	106	4000	(2) 300	3930

**Liters shown is water in suspension in unit and piping. Allow for additional water in bottom of remote sump to cover pump suction and strainer during operation. (300 mm would normally be sufficient.)

† Heaviest section is the coil section.

Refrigerant charge is shown for R-717. Multiply by 1.93 for R-22 and 1.98 for R-134a.

Dimensions are subject to change. Do not use for pre-fabrication.



Engineering Dimensions & Data *Centrifugal Fan Models LSCB 400 to 1610*

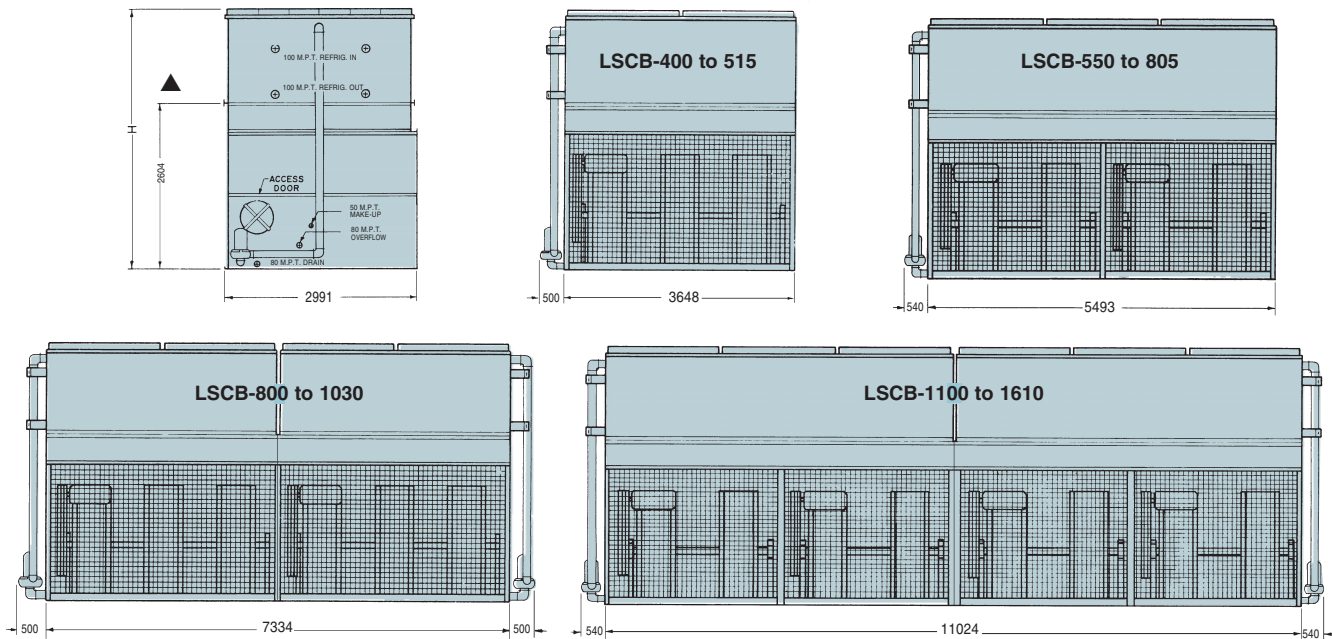

▲ NOTE: Coil connection(s) and other unit dimensions may vary to match application requirements and/or shipping regulations. Consult the EVAPCO plant or certified drawings for detailed information.

TABLE 8 Engineering Data

UNIT NO.	FANS		WEIGHTS (KG)			R-717 Operating Charge	SPRAY PUMP		REMOTE SUMP		HEIGHT (mm)
	kW	m ³ /s	Shipping	Operating	Heaviest Section†		kW	l/s	Liters Req'd**	Conn. Size	
LSCB-400	22,0	33,5	7200	9965	4870	200	4,0	43,2	1552	250	4032
430	18,5	31,4	8175	11050	5870	250	4,0	43,2	1552	250	4248
450	22,0	32,8	8245	11120	5870	250	4,0	43,2	1552	250	4248
480	30,0	35,7	8350	11225	5870	250	4,0	43,2	1552	250	4248
500	30,0	35,0	9265	12245	6870	300	4,0	43,2	1552	250	4464
515	37,0	36,4	9290	12270	6870	300	4,0	43,2	1552	250	4464
LSCB-550	(2)11,0	46,0	10430	14455	7030	300	5,5	65,0	2271	300	4032
590	(2)15,0	49,6	10600	14625	7030	300	5,5	65,0	2271	300	4032
625	(2)18,5	52,5	10710	14735	7030	300	5,5	65,0	2271	300	4032
650	(2)15,0	48,6	12100	16285	8475	372	5,5	65,0	2271	300	4248
690	(2)18,5	51,4	12205	16395	8475	372	5,5	65,0	2271	300	4248
720	(2)22,0	53,8	12310	16495	8475	372	5,5	65,0	2271	300	4248
755	(2)22,0	53,3	13945	18290	10200	450	5,5	65,0	2271	300	4464
805	(2)30,0	57,3	14145	18490	10200	450	5,5	65,0	2271	300	4464
LSCB-800	(2)22,0	66,9	14400	19930	4870	400	(2)4,0	86,4	3104	(2) 250	4032
860	(2)18,5	62,9	16350	22100	5870	500	(2)4,0	86,4	3104	(2) 250	4248
900	(2)22,0	65,6	16490	22240	5870	500	(2)4,0	86,4	3104	(2) 250	4248
960	(2)30,0	71,4	16700	22450	5870	500	(2)4,0	86,4	3104	(2) 250	4248
1000	(2)30,0	70,0	18530	24490	6870	600	(2)4,0	86,4	3104	(2) 250	4464
1030	(2)37,0	72,9	18580	24540	6870	600	(2)4,0	86,4	3104	(2) 250	4464
LSCB-1100	(4)11,0	91,9	20860	28910	7030	600	(2)5,5	130	5678	(2) 300	4032
1180	(4)15,0	99,1	21200	29250	7030	600	(2)5,5	130	5678	(2) 300	4032
1250	(4)18,5	105,0	21420	29470	7030	600	(2)5,5	130	5678	(2) 300	4032
1310	(4)22,0	108,7	21630	29680	7030	600	(2)5,5	130	5678	(2) 300	4032
1380	(4)18,5	102,9	24410	32790	8475	744	(2)5,5	130	5678	(2) 300	4248
1440	(4)22,0	107,6	24620	32990	8475	744	(2)5,5	130	5678	(2) 300	4248
1510	(4)22,0	106,7	27890	36580	10200	898	(2)5,5	130	5678	(2) 300	4464
1610	(4)30,0	114,7	28290	36980	10200	898	(2)5,5	130	5678	(2) 300	4464

**Liters shown is water in suspension in unit and piping. Allow for additional water in bottom of remote sump to cover pump suction and strainer during operation. (300 mm would normally be sufficient.)

† Heaviest section is the coil section.

Refrigerant charge is shown for R-717. Multiply by 1,93 for R-22 and 1,98 for R-134a. Dimensions are subject to change. Do not use for pre-fabrication.

Power Mizer Models PMCB 175 to 375

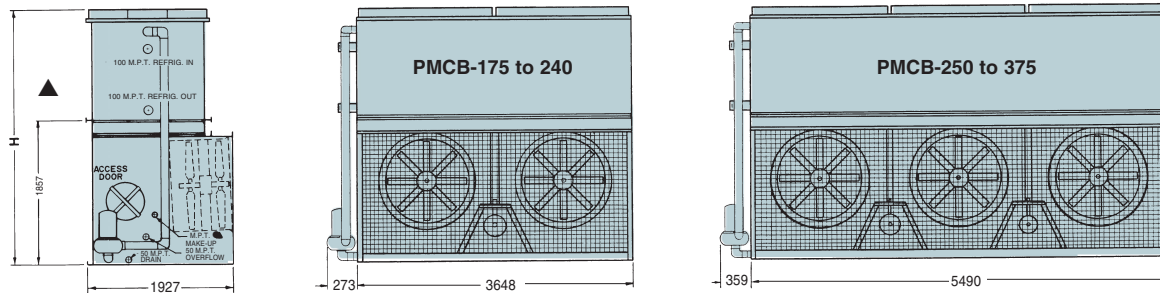

- NOTE: MAKE-UP 25 M.P.T. ON PMCB-175 to PMCB-240
MAKE-UP 40 M.P.T. ON PMCB-250 to PMCB-375

- ▲ NOTE: Coil connection(s) and other unit dimensions may vary to match application requirements and/or shipping regulations. Consult the EVAPCO plant or certified drawings for detailed information.

TABLE 9 Engineering Data

UNIT NO.	FANS		WEIGHTS (KG)			R-717 Operating Charge	SPRAY PUMP		REMOTE SUMP		HEIGHT (mm)
	kW	m ³ /s	Shipping	Operating	Heaviest Section†		kW	l/s	Liters Req'd**	Conn. Size	
PMCB-175	5,5	14,8	3560	4590	2480	100	1,5	21,8	908	200	3286
190	7,5	16,0	3620	4650	2480	100	1,5	21,8	908	200	3286
210	7,5	15,8	4125	5180	2985	125	1,5	21,8	908	200	3502
220	7,5	15,6	4585	5665	3495	150	1,5	21,8	908	200	3718
235	11,0	17,3	4180	5240	2985	125	1,5	21,8	908	200	3502
240	11,0	16,8	4645	5725	3495	150	1,5	21,8	908	200	3718
PMCB-250	7,5 & 4,0	25,5	4755	6045	3035	111	2,2	32,5	1325	250	3070
275	5,5 & 4,0	22,9	5455	6790	3780	150	2,2	32,5	1325	250	3286
295	7,5 & 4,0	24,5	5500	6830	3780	150	2,2	32,5	1325	250	3286
325	7,5 & 4,0	24,0	6275	7650	4530	186	2,2	32,5	1325	250	3502
335	7,5 & 4,0	23,7	6980	8400	5290	225	2,2	32,5	1325	250	3718
360	11,0 & 5,5	26,9	6370	7745	4530	186	2,2	32,5	1325	250	3502
375	11,0 & 5,5	26,6	7075	8495	5290	225	2,2	32,5	1325	250	3718

**Liters shown is water in suspension in unit and piping. Allow for additional water in bottom of remote sump to cover pump suction and strainer during operation. (300 mm would normally be sufficient.)

† Heaviest section is the coil section.
Refrigerant charge is shown for R-717. Multiply by 1,93 for R-22 and 1,98 for R-134a.
Dimensions are subject to change. Do not use for pre-fabrication.

Engineering Dimensions & Data

Power Mizer Models PMCB 290 to 1550

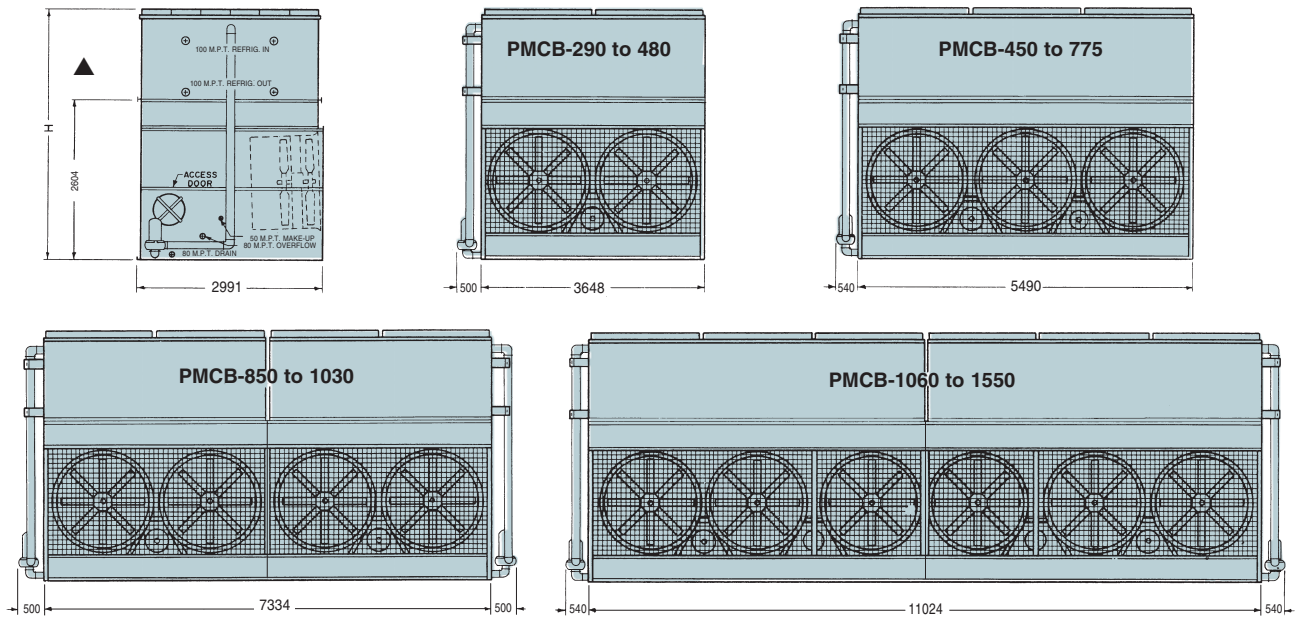

▲ NOTE: Coil connection(s) and other unit dimensions may vary to match application requirements and/or shipping regulations. Consult the EVAPCO plant or certified drawings for detailed information.

TABLE 10 Engineering Data

UNIT NO.	FANS		WEIGHTS (KG)			R-717 Operating Charge	SPRAY PUMP		REMOTE SUMP		HEIGHT (mm)
	kW	m ³ /s	Shipping	Operating	Heaviest Section†		kW	l/s	Liters Req'd**	Conn. Size	
PMCB-290	7,5	29,4	5840	8405	3870	150	4,0	43,2	1590	250	3817
330	5,5	26,7	6755	9410	4870	200	4,0	43,2	1590	250	4033
350	7,5	29,1	6795	9450	4870	200	4,0	43,2	1590	250	4033
385	7,5	28,5	7750	10510	5870	250	4,0	43,2	1590	250	4249
390	11,0	32,0	6865	9515	4870	200	4,0	43,2	1590	250	4033
415	15,0	34,9	6915	9570	4870	200	4,0	43,2	1590	250	4033
425	11,0	31,2	7820	10580	5870	250	4,0	43,2	1590	250	4249
455	15,0	34,2	7875	10630	5870	250	4,0	43,2	1590	250	4249
480	18,5	36,1	7940	10695	5870	250	4,0	43,2	1590	250	4249
PMCB-450	7,5 & 4,0	45,5	8630	12330	5615	222	5,5	65,0	2347	300	3817
585	7,5 & 4,0	43,7	11600	15615	8475	372	5,5	65,0	2347	300	4249
630	15,0 & 7,5	53,2	10300	14155	7030	300	5,5	65,0	2347	300	4033
645	11,0 & 5,5	48,1	11685	15700	8475	372	5,5	65,0	2347	300	4249
690	15,0 & 7,5	51,6	11755	15765	8475	372	5,5	65,0	2347	300	4249
725	18,5 & 11,0	54,2	12000	16010	8475	372	5,5	65,0	2347	300	4248
755	18,5 & 11,0	53,8	13330	17505	9920	450	5,5	65,0	2347	300	4465
775	22,0 & 11,0	55,2	13575	17750	9920	450	5,5	65,0	2347	300	4465
PMCB-850	(2)11,0	62,4	15640	21160	5870	500	(2)4,0	86,4	3217	(2) 250	4249
910	(2)15,0	68,4	15750	21260	5870	500	(2)4,0	86,4	3217	(2) 250	4249
950	(2)15,0	67,2	17625	23385	6870	600	(2)4,0	86,4	3217	(2) 250	4465
960	(2)18,5	72,2	15880	21390	5870	500	(2)4,0	86,4	3217	(2) 250	4249
1000	(2)18,5	70,8	17750	23510	6870	600	(2)4,0	86,4	3217	(2) 250	4465
1030	(2)22,0	72,8	17895	23655	6870	600	(2)4,0	86,4	3217	(2) 250	4465
PMCB-1060	(2) 7,5 & (2) 4,0	87,6	20280	27990	7030	600	(2)5,5	130,0	6132	(2) 300	4033
1175	(2) 11,0 & (2) 5,5	98,6	20455	28165	7030	600	(2)5,5	130,0	6132	(2) 300	4033
1260	(2) 15,0 & (2) 7,5	106,4	20600	28310	7030	600	(2)5,5	130,0	6132	(2) 300	4033
1380	(2) 15,0 & (2) 7,5	103,2	23510	31530	8475	744	(2)5,5	130,0	6132	(2) 300	4249
1510	(2) 18,5 & (2) 11,0	107,6	26660	35010	9920	900	(2)5,5	130,0	6132	(2) 300	4465
1550	(2) 22,0 & (2) 11,0	110,4	27150	35500	9920	900	(2)5,5	130,0	6132	(2) 300	4465

**Liters shown is water in suspension in unit and piping. Allow for additional water in bottom of remote sump to cover pump suction and strainer during operation. (300 mm would normally be sufficient.)

† Heaviest section is the coil section.

Refrigerant charge is shown for R-717. Multiply by 1,93 for R-22 and 1,98 for R-134a. Dimensions are subject to change. Do not use for pre-fabrication.

Power Mizer Models PMCB 435 to 1770

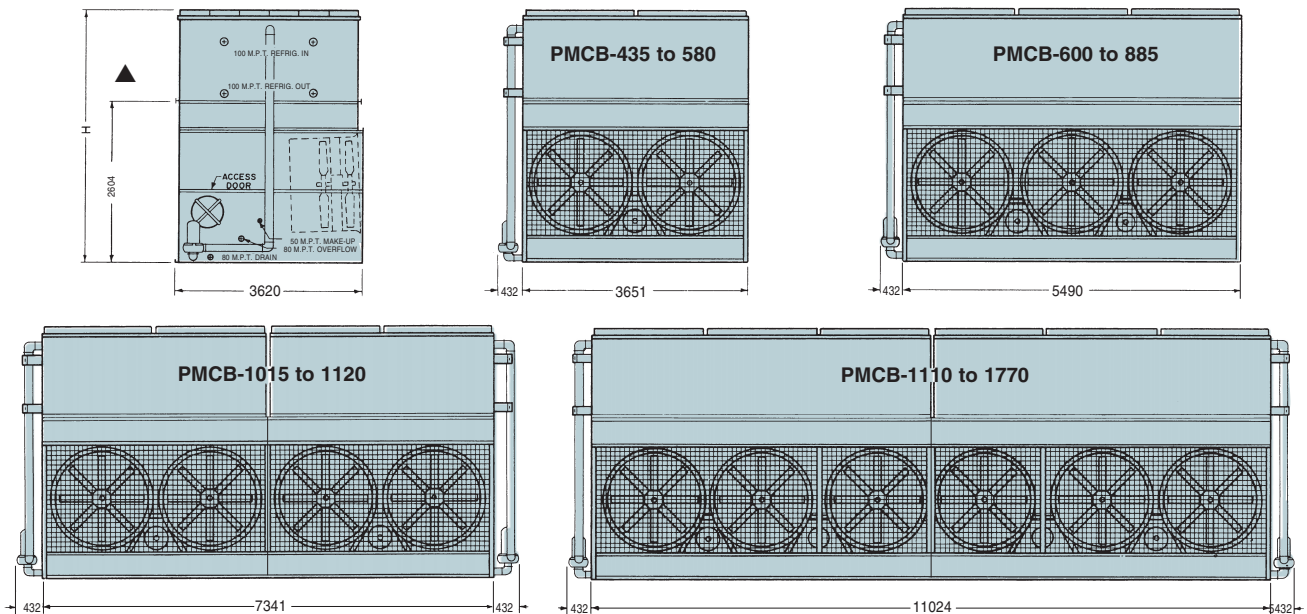

▲ NOTE: Coil connection(s) and other unit dimensions may vary to match application requirements and/or shipping regulations. Consult the EVAPCO plant or certified drawings for detailed information.

TABLE 11 Engineering Data

UNIT NO.	FANS		WEIGHTS (KG)			R-717 Operating Charge	SPRAY PUMP		REMOTE SUMP		HEIGHT (mm)
	kW	m ³ /s	Shipping	Operating	Heaviest Section†		kW	l/s	Liters Req'd**	Conn. Size	
PMCB-435	11,0	35,0	8165	11070	5965	240	4,0	50,5	1893	250	4337
475	11,0	34,9	9365	12390	7160	300	4,0	50,5	1893	250	4553
495	18,5	41,2	8285	11190	5965	240	4,0	50,5	1893	250	4337
510	22,0	42,4	8355	11265	5965	240	4,0	50,5	1893	250	4337
535	18,5	40,1	9485	12510	7160	300	4,0	50,5	1893	250	4553
540	15,0	37,5	10580	13715	8265	358	4,0	50,5	1893	250	4769
560	18,5	39,6	10645	13780	8265	358	4,0	50,5	1893	250	4769
580	22,0	41,0	10720	13855	8265	358	4,0	50,5	1893	250	4769
PMCB-600	15,0 & 7,5	60,9	10295	14295	6885	272	5,5	75,7	2763	300	4121
660	11,0 & 5,5	55,7	12045	16270	8580	363	5,5	75,7	2763	300	4337
705	15,0 & 7,5	59,2	12115	16345	8580	363	5,5	75,7	2763	300	4337
770	15,0 & 7,5	57,5	13930	18375	10315	454	5,5	75,7	2763	300	4553
805	15,0 & 7,5	57,0	15580	20255	12045	544	5,5	75,7	2763	300	4769
815	18,5 & 11,0	60,8	14175	18620	10315	454	5,5	75,7	2763	300	4553
855	22,0 & 11,0	63,7	14245	18695	10315	454	5,5	75,7	2763	300	4553
885	22,0 & 11,0	62,7	16070	20745	12045	544	5,5	75,7	2763	300	4769
PMCB-1015	(2)15,0	75,5	18840	24890	7160	600	(2)4,0	100,9	3785	(2) 250	4553
1080	(2)15,0	74,9	21160	27430	8365	717	(2)4,0	100,9	3785	(2) 250	4769
1120	(2)18,5	79,3	21290	27560	8365	717	(2)4,0	100,9	3785	(2) 250	4769
PMCB-1110	(2) 11,0 & (2) 5,5	112,3	20440	28440	6885	544	(2)5,5	151,4	5526	(2) 300	4121
1320	(2) 11,0 & (2) 5,5	111,4	24090	32540	8580	726	(2)5,5	151,4	5526	(2) 300	4337
1410	(2) 15,0 & (2) 7,5	118,5	24230	32690	8580	726	(2)5,5	151,4	5526	(2) 300	4337
1485	(2) 18,5 & (2) 11,0	124,6	24720	33180	8580	726	(2)5,5	151,4	5526	(2) 300	4337
1540	(2) 22,0 & (2) 11,0	129,3	25210	33670	8580	726	(2)5,5	151,4	5526	(2) 300	4337
1630	(2) 18,5 & (2) 11,0	121,6	28350	37240	10315	907	(2)5,5	151,4	5526	(2) 300	4553
1710	(2) 22,0 & (2) 11,0	127,4	28490	37390	10315	907	(2)5,5	151,4	5526	(2) 300	4553
1770	(2) 22,0 & (2) 11,0	125,3	32140	41490	12045	1089	(2)5,5	151,4	5526	(2) 300	4769

** Liters shown is water in suspension in unit and piping. Allow for additional water in bottom of remote sump to cover pump suction and strainer during operation (300 mm would normally be sufficient.)

† Heaviest section is the coil section.
Refrigerant charge is shown for R-717. Multiply by 1,93 for R-22 and 1,98 for R-134a.
Dimensions are subject to change. Do not use for pre-fabrication.

Application

Design

Evapco units are heavy-duty construction and designed for long trouble-free operation. Proper equipment selection, installation and maintenance is, however, necessary to ensure good unit performance. Some of the major considerations in the application of a condenser are presented below. For additional information, contact the factory.

Air Circulation

In reviewing the system design and unit location, it is important that proper air circulation be provided. The best location is on an unobstructed roof top or on ground level away from walls and other barriers. Care must be taken when locating condensers in wells or enclosures or next to high walls. The potential for recirculation of hot, moist discharge air back into the fan intake exists. Recirculation raises the wet bulb temperature of the entering air causing the condensing pressure to rise above the design. For these cases, a discharge hood or ductwork should be provided to raise the overall unit height even with the adjacent wall, thereby reducing the chance of recirculation. Good engineering practice dictates that the evaporative condenser's discharge air not be directed or located close to or in the vicinity of building air intakes. Engineering assistance is available from the factory to identify potential recirculation problems and recommend solutions.

For additional information regarding layout of evaporative condensers, see Evapco Bulletin entitled "Equipment Layout".

Structural Steel Support

The recommended method of support for EVAPCO condensers is two structural "I" beams located under the outer flanges and running the entire length of the unit. Mounting holes 19mm in diameter, are located in the bottom channels of the pan section to provide for bolting to the structural steel; refer to certified drawings from the factory for bolt hole locations. Beams should be level to within 1.7 mm per meter before setting the unit in place. Do not level the unit by shimming between it and the "I" beams as this will not provide proper longitudinal support.

Vibration Isolation

The fans on EVAPCO units are balanced and run virtually vibration free. In addition, the rotating mass is very small in relation to the total mass of the condenser, further reducing the possibility of objectionable vibration being transmitted to the building structure.

As a result, vibration isolation is generally not required. In those cases where it is determined that vibration isolation is necessary, spring type vibration isolator rails can be furnished. The rails are constructed of heavy gauge Z-725 hot-dip galvanized steel for superior corrosion resistance. Rails are designed to be mounted between the condenser and the supporting steel framework. They are 90% efficient and have approximately 25 mm static deflection. Rails are designed for wind loading up to 80 km/hr.

It is important to note that vibration isolation must be installed continuously along the full length of the condenser on both sides of the unit. Point isolators may be used between the supporting steel and the building framework, but not between the unit and the supporting steel

Indoor Installations

Centrifugal fan models can be installed indoors where it is desirable to hide the unit or where it is the only location available. Discharge ductwork is required for these installations. Normally it is best to use the room as a plenum for inlet air, but inlet ductwork can be used if required.

The design of ductwork should be symmetrical to provide even air distribution across both intake and discharge openings. The static pressure loss imposed by the ductwork must not exceed 125 Pa. Care must be taken to provide large access doors in the ductwork for accessibility to the unit fan section, eliminators and water distribution system for normal maintenance.

The centrifugal fan condenser can handle the external static of ductwork by using the next larger size fan motor. Units installed with inlet ductwork should also be ordered with the solid bottom panel option. Drawings are available from the factory showing size and location of duct connections.

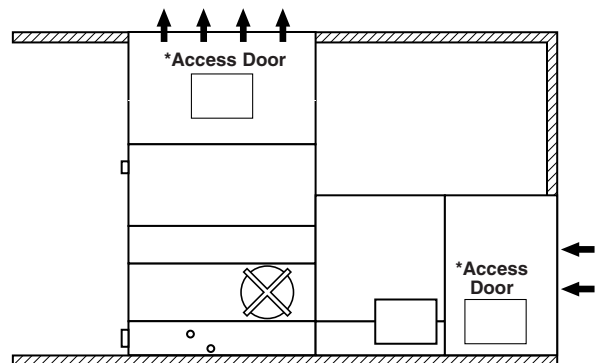

Maintaining the Recirculated Water System

The heat rejection in a condenser is accomplished by the evaporation of a portion of the recirculated spray water. As this water evaporates, it leaves behind all of its mineral content and impurities. Therefore, it is important to bleed-off an amount of water equal to that which is evaporated to prevent the build-up of these impurities. If this is not done, the mineral or the acidic nature of the water will continue to increase. This will ultimately result in heavy scaling or a corrosive condition.

Applications

Bleed-off

Each unit supplied with a pump mounted on the side is furnished with a clear bleed line for visual inspection and a valve which, when fully open, will bleed-off the proper amount of water. If the make-up water supplying to the unit is relatively free of impurities, it may be possible to cut back the bleed, but the unit must be checked frequently to make sure scale is not forming. Make-up water pressure should be maintained between 140 and 340 kPa.

Water Treatment

In some cases the make-up will be so high in mineral content that a normal bleed-off will not prevent scaling. In these cases water treatment will be required and a reputable water treatment company familiar with the local water conditions should be consulted.

Any chemical water treatment used must be compatible with the galvanized construction of the unit. If acid is used for treatment, it should be accurately metered and the concentration properly controlled. The pH of the water should be maintained between 6.5 and 8.0. Units constructed of galvanized steel operating with circulating water having a pH of 8.3 or higher will require periodic passivation of the galvanized steel to prevent the formation of "white rust". Batch chemical feeding is not recommended because it does not afford the proper degree of control. If acid cleaning is required extreme caution must be exercised and only inhibited acids recommended for use with galvanized construction should be used. For more information see EVAPCO Bulletin entitled "Maintenance Instructions".

Control of Biological Contamination

Water quality should be checked regularly for biological contamination. If biological contamination is detected, a more aggressive water treatment and mechanical cleaning program should be undertaken. The water treatment program should be performed in conjunction with a qualified water treatment company. It is important that all internal surfaces be kept clean of accumulated dirt and sludge. In addition, the drift eliminators should be maintained in good operating condition

Note: The location of the evaporative condenser must be considered during the equipment layout stages of a project. It is important to prevent the discharge air (potential of biological contamination) from being introduced into the fresh air intakes of the building.

Recirculating Water System - Freeze Protection

Water lines to and from the unit, spray pump and related piping should be heat traced and insulated up to the overflow level in order to protect from freezing.

The unit should not be operated dry (fans on, pump off) unless the basin is completely drained and the unit has been designed for dry operation.

REMOTE SUMP

Whenever a condenser is idled during subfreezing weather, the water in the sump must be protected from freezing and damaging the pan. The simplest and most reliable method of accomplishing this is with a remote sump tank located in a heated space in the building under the condenser. The recirculating water pump is mounted at the remote sump and whenever it is shut-off, all of the water drains into the indoor tank. When a condenser is ordered for remote sump operation, the standard float valve and strainer are omitted, and the unit is provided with an oversized bottom water outlet connection. Where a remote sump is not possible, a supplementary means of heating the pan water must be provided.

ELECTRIC HEATERS

Electric immersion heaters are available factory installed in the basin of the condenser. They are sized to maintain a +4 or +5°C pan water temperature with -18°C ambient air temperature with the fans and pumps off. They are furnished with a thermostat and low water protection device to cycle the heater on when required and to prevent the heater elements from energizing unless they are completely submerged. Components are enclosed in rugged, weatherproof enclosures for outdoor use. The heater power contactors and electric wiring are not included as standard.

Electric Pan Heaters

Model No.	kW*
LSCB 36 to 80	2
LSCB 90 to 170	3
LSCB 185 to 250	4
LSCB 280 to 385	(2) 3
LSCB 281 to 386	5
LSCB 410 to 560	(2) 4
LSCB 591 to 770	(2) 5
LSCB 820 to 1120	(2) 8
LSCB 400 to 515	8
LSCB 550 to 805	(2) 5
LSCB 800 to 1030	(2) 8
LSCB 1100 to 1610	(2) 10
LRC 25 to 72	2
LRC 76 to 114	3
LRC 108 to 183	4
LRC 190 to 246	6
LRC 188 to 269	7
LRC 249 to 379	9
PMCB 175 to 240	5
PMCB 250 to 375	(2) 4
PMCB 290 to 480	8
PMCB 450 to 775	(2) 6
PMCB 850 to 1030	(2) 8
PMCB 1060 to 1550	(4) 6
PMCB 435 to 580	(2) 6
PMCB 600 to 885	(2) 8
PMCB 1015 to 1120	(2) 12
PMCB 1110 to 1770	(2) 16

* Electric heater selection based on -18°C ambient temperature. For alternate low ambient heater selections, consult the factory.

Steel Support

The recommended support for EVAPCO condensers is structural "I" beams located under the outer flanges and running the entire length of the unit. Mounting holes, 19mm in diameter are located in the bottom channels of the pan section to provide for bolting to the structural steel. (Refer to certified drawings from the factory for bolt hole locations.)

Beams should be level to within 3mm per 2m before setting the unit in place. Do not level the unit by shimming between it and the "I" beams as this will not provide proper longitudinal support.

Plan Views

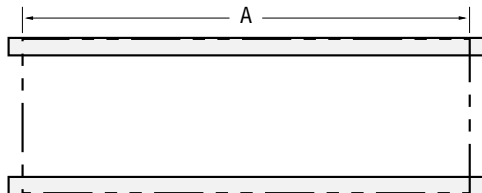

End Elevations

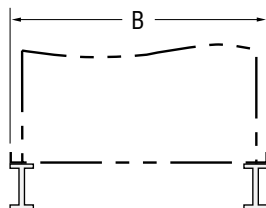

LRC DIMENSIONS

Models		A	B
LRC	25 to 72	3083	1029
LRC	76 to 114	3731	1540
	108 to 183	4636	1540
	190 to 246	5553	1540
LRC	188 to 269	4629	2388
	249 to 379	5553	2388

LSCB DIMENSIONS

Models		A	B
LSCB	36 to 80	1826	1235
	90 to 120	2724	1235
	135 to 170	3651	1235
LSCB	185 to 250	3645	1664
	280 to 385	5490	1664
LSCB	281 to 386	3651	2388
	410 to 560	5486	2388
	581 to 770	7341	2388
	820 to 1120	11011	2388
LSCB	400 to 515	3648	2991
	550 to 805	5493	2991
	800 to 1030	7334	2991
	1100 to 1610	11024	2991

PMCB DIMENSIONS

Models		A	B
PMCB	175 to 240	3648	1927
	250 to 375	5493	1927
PMCB	290 to 480	3648	2991
	450 to 775	5490	2991
	850 to 1030	7334	2991
	1060 to 1550	11024	2991
PMCB	435 to 580	3651	3620
	600 to 885	5490	3620
	1015 to 1120	7341	3620
	1110 to 1120	11024	3620

Evaporative Condenser Specifications

Furnish and install as shown on the plan an Evapco Evaporative Condenser Model _____ having condensing capacity of _____ kW heat rejection operating with _____ Refrigerant at _____ °C condensing temperature and _____ °C design wet bulb temperature.

Casing and Fan Section

The casing and fan section shall be constructed of Z-725 galvanized steel for long life and durability. Fan section shall include fans, motors and drives. The entire drive system (including fans, motors, pulleys and belts) shall be located in the dry entering airstream.

Cold Water Basin *(only for LRC)*

The complete cold water basin shall be constructed of Type 304 stainless steel for long life and durability.

Standard cold water basin accessories shall include Type 304 stainless steel overflow, drain, anti-vortex hood, strainers and brass make-up valve with unsinkable, foam filled plastic float. A circular access door shall be located above the basin to allow easy access to the pan interior.

The outlet shall be Type 304 stainless steel beveled for welding or a threaded connection.

Model LSCB & LRC - Centrifugal Fans/Drives

Fans shall be forwardly curved centrifugal type of hot-dip galvanized construction. The fans shall be factory installed into the pan-fan section, and statically and dynamically balanced for vibration free operation. Fans shall be mounted on either a solid steel shaft or a hollow steel shaft with forged bearing journals. The fan shaft shall be supported by heavy-duty, self-aligning bearings with cast-iron housings and lubrication fittings provided for maintenance.

The fan drive shall be V-belt type with taper lock pulleys designed for 150% of the motor nameplate kW. Drives are to be mounted and aligned at the factory.

Model PMCB - Power-Mizer Fans/Drives

Fans shall be vane-axial type constructed of cast aluminum alloy blades. They shall be arranged in a two-stage system installed in a closely fitted cowl with venturi air inlet and air stabilizing vanes. Fan shaft bearings shall be heavy-duty self-aligning ball type with grease fittings extended to the outside of the unit.

The fan drive shall be solid backed Power-Band constructed of neoprene with polyester cords and designed for 150% of motor nameplate kW. Drives are to be mounted and aligned at the factory.

Fan Motor

Fan motor(s) shall be _____ kW T.E.F.C. suitable for outdoor installation on _____ volts, _____ hertz, and _____ phase electrical service. Motor(s) shall be mounted on an adjustable base.

Heat Transfer Coil

The coil(s) shall be all prime surface steel, encased in steel framework with the entire assembly hot-dip galvanized after fabrication. Coil(s) shall be designed with sloping tubes for free drainage of liquid and air pressure tested under water in accordance with the "Pressure Equipment Directive" (PED) 97/23/EC.

Water Recirculation Pump

The pump shall be a close-coupled, centrifugal type with a mechanical seal. Pump motor shall be _____ kW T.E.F.C. design suitable for outdoor installation on _____ volts, _____ hertz, and _____ phase electrical service.

Water Distribution System

The system shall provide a water flow rate of not less than 4 l/s over each square meter of unit face area to ensure proper flooding of the coil. The spray header shall be constructed of polyvinyl chloride pipe for corrosion resistance. All spray branches shall be removable and include a threaded end plug for cleaning. The water shall be distributed over the entire coil surface by precision molded from heavy-duty, glass reinforced nylon spray nozzles for long life and 100% corrosion resistance (34 mm diameter orifice and 38 mm clearance between the nozzle bottom and water diverter plate) with an internal sludge ring to eliminate clogging. Nozzles shall be threaded into the spray header to provide easy removal for maintenance.

Eliminators

The eliminators shall be constructed of inert polyvinyl chloride that has been specially treated to resist UV degradation. Assembled in easily handled sections, the eliminators shall incorporate three changes in air direction to assure removal of entrained moisture from the discharge airstream. The maximum drift rate shall not exceed 0.001% of the recirculated water rate.

Finish

The casing and fan section shall be constructed of Z-725 heavy gauge mill hot-dip galvanized steel. During fabrication, all panel edges shall be coated with a 95% pure zinc compound.



★ World Headquarters /
Research and
Development Center

■ EVAPCO Manufacturing
Facilities

EVAPCO ... Specialists in Heat Transfer Products and Services

EVAPCO, Inc. - World Headquarters & Research / Development Center

EVAPCO, Inc. • P.O. Box 1300 • Westminister, MD 21158 USA
Phone: +1 410-756-2600 • Fax: +1 410-756-6450 • E-mail: marketing@evapco.com

EVAPCO Europe

**EVAPCO Europe N.V.
European Headquarters**
Heersterveldweg 19
Industriezone, Tongeren-Oost
3700 Tongeren, Belgium
Phone: +32 12-395029
Fax: +32 12-238527
E-mail: evapco.europe@evapco.be

EVAPCO Europe S.r.l.
Via Ciro Menotti 10
20017 Passirana di Rho
Milan, Italy
Phone: +39 02-939-9041
Fax: +39 02-935-00840
E-mail: evapcoeuropa@evapco.it

EVAPCO Europe S.r.l.
Via Dosso 2
23020 Piateda Sondrio, Italy

EVAPCO Europe GmbH
Bovert 22
40670 Meerbusch, Germany
Phone: +49 2159-69560
Fax: +49 2159-695611
E-mail: info@evapco.de

EVAPCO Worldwide Facilities

EVAPCO, Inc.
Westminister, MD 21158 USA

EVAPCO Iowa
Lake View, IA 51450 USA

EvapTech, Inc.
Lenexa, KS 66214 USA

EVAPCO Asia/Pacific Headquarters
Shanghai, P.R. China

EVAPCO East
Taneytown, MD 21787 USA

EVAPCO Iowa
Owatonna, MN 55060 USA

Tower Components, Inc.
Ramseur, NC 27316 USA

EVAPCO Refriger. Equipm. Co., Ltd.
Shanghai, P.R. China

EVAPCO Midwest
Greenup, IL 62428 USA

Refrigeration Valves & Systems Co.
Bryan, TX 77808 USA

EVAPCO S.A. (Pty.) Ltd.
Isando 1600, Republic of South Africa

EVAPCO Refriger. Equipm. Co., Ltd.
Beijing, P.R. China

EVAPCO West
Madera, CA 93637 USA

McCormack Coil Company, Inc.
Lake Oswego, OR 97035 USA

Tiba Engineering Industries Co.
Heliopolis, Cairo, Egypt

Aqua-Cool Towers (Pty.) Ltd.
Riverstone, N.S.W. Australia 2765

Visit EVAPCO's Websites at:
<http://www.evapco.com>
<http://www.evapco.eu>

