

Küba Green Line

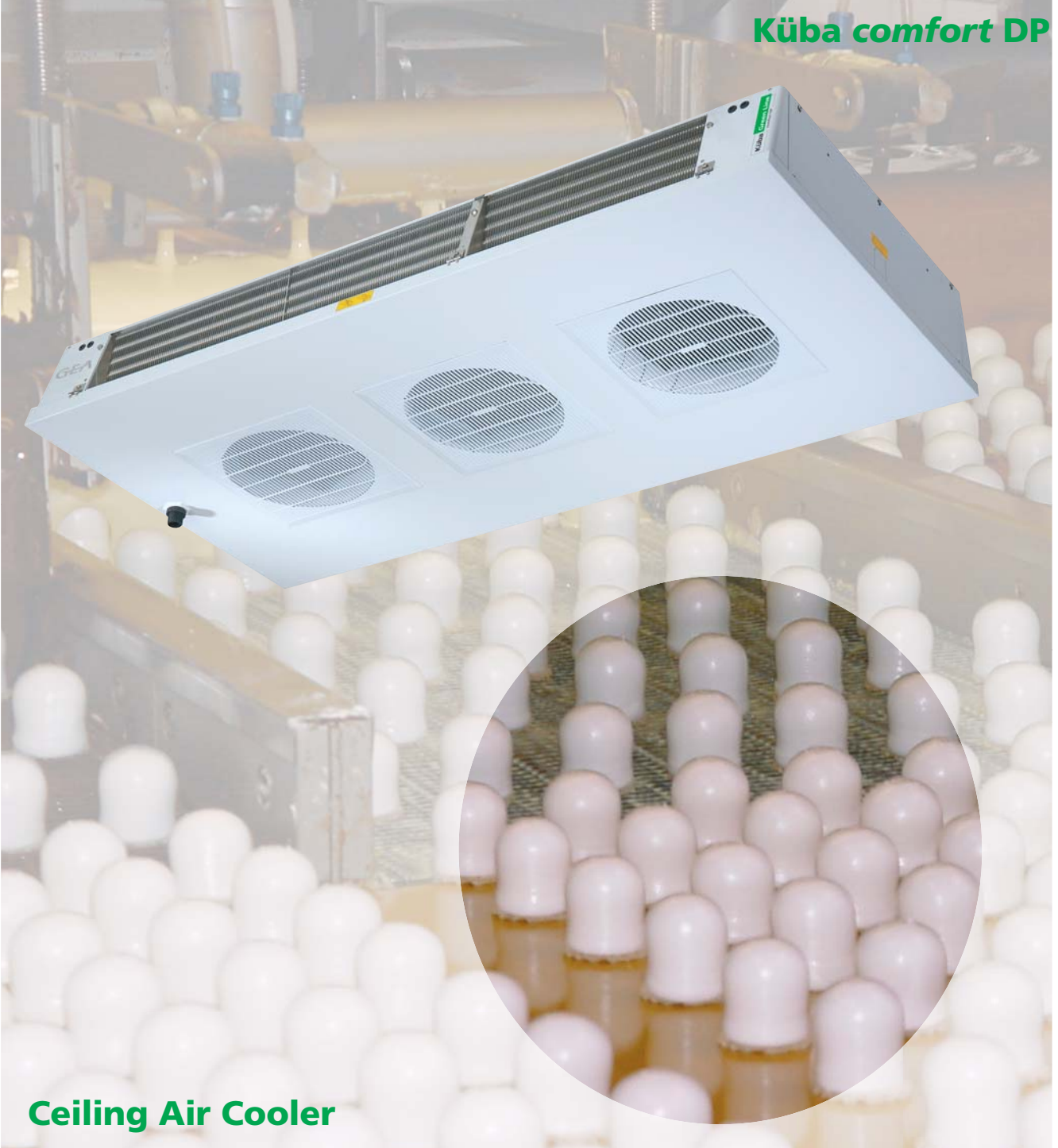

Küba comfort DP



Ceiling Air Cooler

<p>Q_0</p> <p>2,2  28 kW</p>	<p>+20 °C  DP</p> <p>±0 °C</p> <p>t_{1}</p>		<p>EUROVENT CERTIFIED PERFORMANCE</p>  <p>"CERTIFY ALL" Air Coolers</p>
--	---	--	--

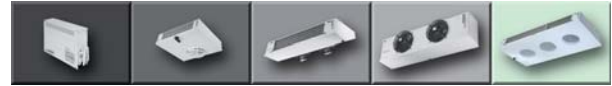

Application Benefits for Contractors and Operators

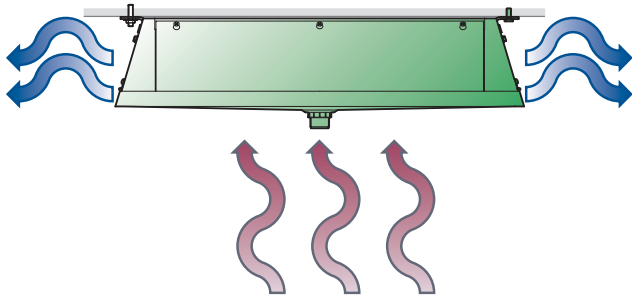

Expanded capacity range

- Up to 28 kW

Low draught levels

- Integrated air baffle plate for low air speed in cooling room
- Low-noise version integrated, with fans as standard (normal speed „S“, quiet speed „L“)
- Extremely quiet version in the speed „S“ with accessory (capacitor)

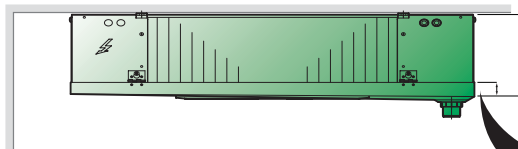

Space-saving

- Height 303 mm

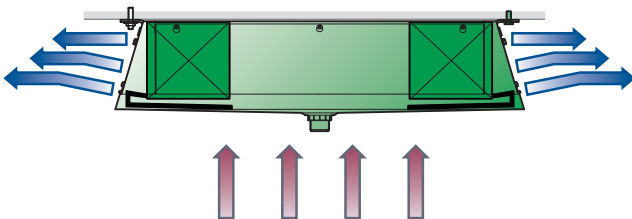
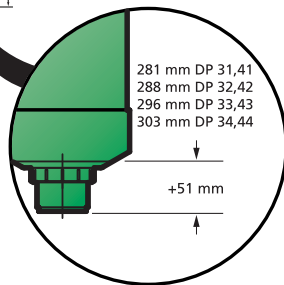

Best air guidance

- Integrated air baffle plate
- Low fan speed (up to 0.8 m/s)
- Directs the air to the ceiling of the room and therefore projects it far into the room

Nomenclature

Standard

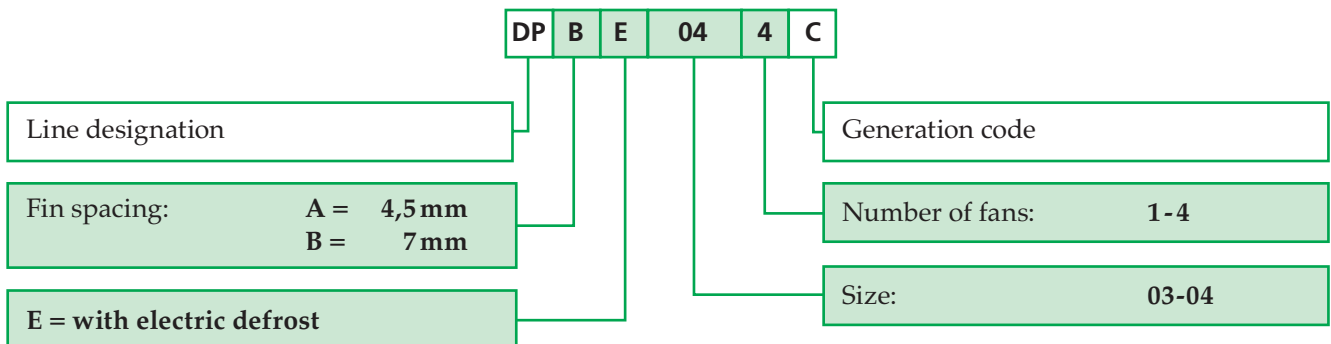

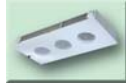

Construction

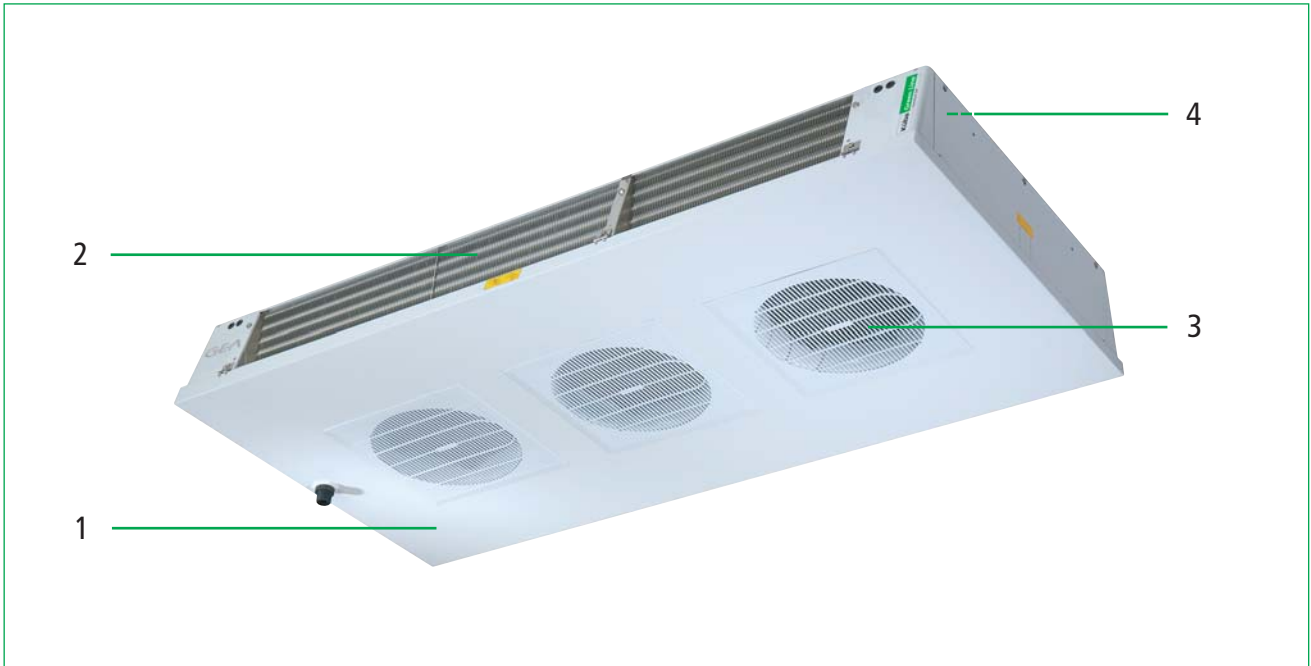

1. Casing

- Sendzimir zinc-plated steel, smooth
- High-quality powder coating, papyrus white RAL 9018
 - Food-safe
 - Easy to clean
 - Best corrosion protection
- Drip tray and side pieces removable
- Drip tray folding at both sides

2. Cooler

- Internal cleanliness acc. to DIN 8964
- Fin spacing: DP.A: 4,5 mm, DP.B: 7,0 mm
- Tubing Cu-Special, Fins Al, End plates Al
- Küba-CAL® refrigerant distributor, with multiple injection

3. Fans CE

- Multi-stage fans wired up to an internal terminal box
- With built-in protector, without external contacts
- Ø 350 mm
- Plug connection on motor

- Application range: RT: -30 °C to +60 °C
- 230 V ±10 %, V-1, 50/60 Hz, adjustable (transformer)
- Minimum Voltage = 100 V
- Index of protection IP44 acc. to DIN 40050
- Insulation class F acc. to VDE 0700
- Operating values are the actual values of the built-in motor at +20 °C and with dry surface
- Model plate information differ from the specified operating values (see installation instructions)

Motor label data (max. allowable value +40 °C)

	Ø mm	50 Hz			60 Hz		
		min ⁻¹	W	A	min ⁻¹	W	A
DP. 031-044C	350	1390	140	0,62	1550	195	0,86

4. Electric defrost

- Pre-wired, ready to connect in terminal box
- To prevent steam build-up and to accomplish heat exchange with almost no loss, the heaters are mounted in special expanded tube sleeves
- 230 V-1 / 400 V-3
- With defrosting water drain plates



Technical data

DPA(E)...C Normal Speed N



3,6 kW 16 kW

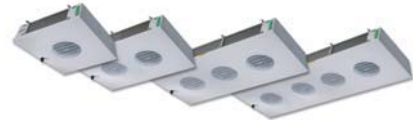
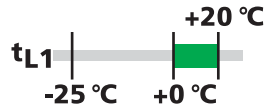

Model	Rating Q_0 at 50 Hz DT1, R404A		Surface	Air flow	Air throw	Tube volume	Connections		Sound L_{WA}	Blade	Fans \odot (Operating values at 50 Hz)				Electr. defrost
	$t_{li} \pm 0^\circ\text{C}$ DT1 = 8K	$t_{li} +10^\circ\text{C}$ DT1 = 10 K					Inlet	Outlet			Type of current	Per Fan	W	A	
	kW	kW	m^2	m^3/h	m	dm^3	\varnothing mm	\varnothing mm	dB(A)	St. x \varnothing mm	230±10% V-1 50/60Hz	min^{-1}	W	A	kW
DPA 031C	3,69	5,41	16,3	1720	2x11	3,4	10*	22	74	1 x 350	230V-1	1320	185	0,72	2,30
DPA 041C	4,26	6,25	24,3	1620	2x9	5,1	10*	22	74	1 x 350	230V-1	1320	185	0,72	2,30
DPA 032C	7,38	10,8	32,6	3440	2x12	6,8	10*	28	77	2 x 350	230V-1	1320	185	0,72	4,14
DPA 042C	8,52	12,5	48,6	3240	2x10	10,2	10*	28	77	2 x 350	230V-1	1320	185	0,72	4,14
DPA 033C	11,1	16,3	48,9	5160	2x13	10,2	10*	28	79	3 x 350	230V-1	1320	185	0,72	5,96
DPA 043C	12,8	18,8	72,9	4860	2x11	15,3	15*	35	79	3 x 350	230V-1	1320	185	0,72	5,96
DPA 034C	14,8	21,7	65,2	6880	2x14	13,6	15*	35	80	4 x 350	230V-1	1320	185	0,72	7,84
DPA 044C	17,0	25,0	97,2	6480	2x12	20,4	22*	35	80	4 x 350	230V-1	1320	185	0,72	7,84

Q_V - diagram (R22, R134A, R404A, R507)

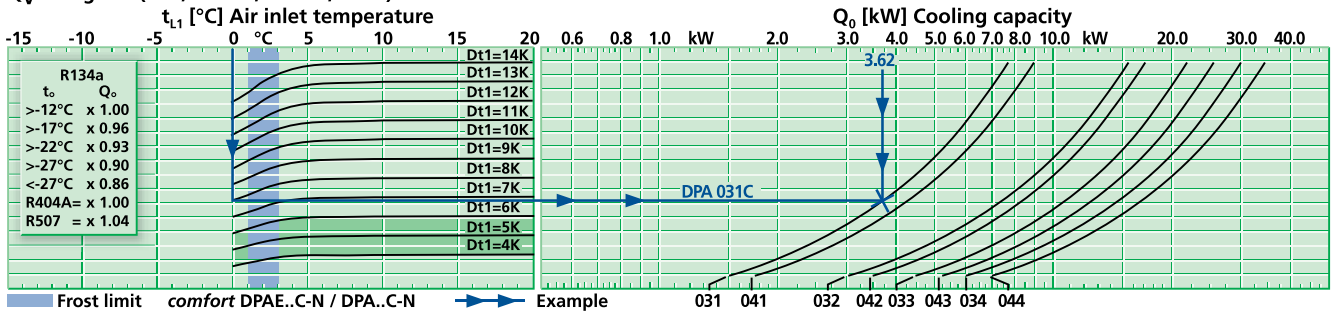

Technical data

DPA(E)...C Quiet Speed L



Model	Rating Q_0 at 50 Hz DT1, R404A		Surface	Air flow	Air throw	Tube volume	Connections		Sound L_{WA}	Blade	Fans \odot (Operating values at 50 Hz)				Electr. defrost
	$t_{li} \pm 0^\circ\text{C}$ DT1 = 8K	$t_{li} +10^\circ\text{C}$ DT1 = 10 K					Inlet	Outlet			Type of current	Per Fan	W	A	
	kW	kW	m^2	m^3/h	m	dm^3	\varnothing mm	\varnothing mm	dB(A)	St. x \varnothing mm	230±10% V-1 50/60Hz	min^{-1}	W	A	kW
DPA 031C	2,66	3,71	16,3	1064	2x8	3,4	10*	22	64	1 x 350	230V-1	930	195	0,79	2,30
DPA 041C	2,78	3,96	24,3	950	2x5	5,1	10*	22	64	1 x 350	230V-1	930	195	0,79	2,30
DPA 032C	5,32	7,43	32,6	2128	2x9	6,8	10*	28	67	2 x 350	230V-1	930	195	0,79	4,14
DPA 042C	5,56	7,92	48,6	1900	2x6	10,2	10*	28	67	2 x 350	230V-1	930	195	0,79	4,14
DPA 033C	7,98	11,1	48,9	3192	2x10	10,2	10*	28	69	3 x 350	230V-1	930	195	0,79	5,96
DPA 043C	8,34	11,9	72,9	2850	2x7	15,3	15*	35	69	3 x 350	230V-1	930	195	0,79	5,96
DPA 034C	10,6	14,9	65,2	4256	2x11	13,6	15*	35	70	4 x 350	230V-1	930	195	0,79	7,84
DPA 044C	11,1	15,9	97,2	3800	2x8	20,4	22*	35	70	4 x 350	230V-1	930	195	0,79	7,84

Q_V - diagram (R22, R134A, R404A, R507)

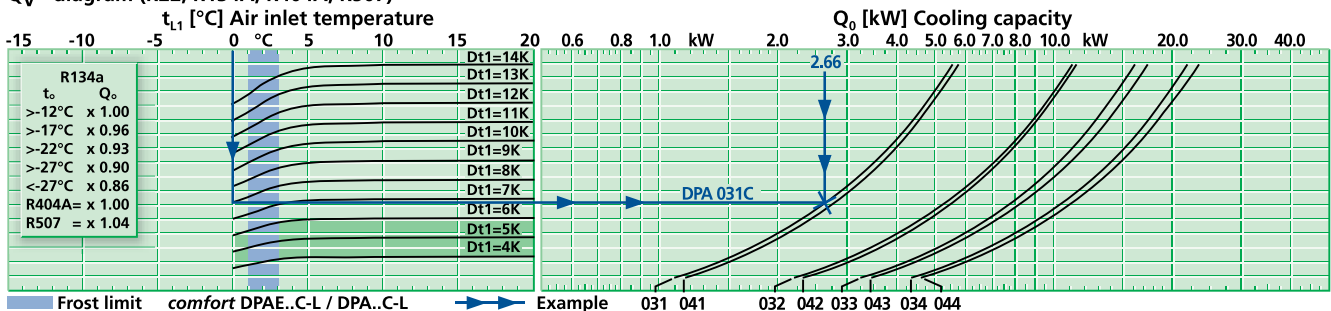

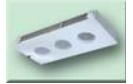

Technical data

DPA(E)...C Very quiet Speed S



1,9 kW 8 kW

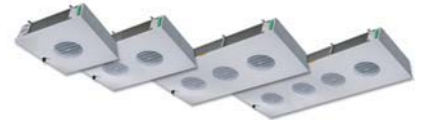
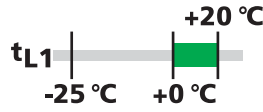

Model	Rating Q_0 at 50 Hz DT1, R404A		Surface m^2	Air flow m^3/h	Air throw m	Tube volume dm^3	Connections		Sound L_{WA}	Blade St. x \emptyset mm	Fans \oplus (Operating values at 50 Hz)			Electr. defrost kW	
	$t_{li} \pm 0^\circ C$ DT1 = 8K	$t_{li} +10^\circ C$ DT1 = 10K					Inlet \emptyset mm	Outlet \emptyset mm			Type of current	Per Fan min^{-1}	W		A
	kW	kW							dB(A)		230 \pm 10% V-1 50/60Hz				
DPA 031C	2,07	3,04	16,3	760	2x5	3,4	10*	22	56	1 x 350	230V-1	660	195	0,79	2,30
DPA 041C	2,13	3,13	24,3	670	2x4	5,1	10*	22	56	1 x 350	230V-1	660	195	0,79	2,30
DPA 032C	4,14	6,08	32,6	1520	2x6	6,8	10*	28	59	2 x 350	230V-1	660	195	0,79	4,14
DPA 042C	4,26	6,25	48,6	1340	2x5	10,2	10*	28	59	2 x 350	230V-1	660	195	0,79	4,14
DPA 033C	6,21	9,11	48,9	2280	2x7	10,2	10*	28	61	3 x 350	230V-1	660	195	0,79	5,96
DPA 043C	6,39	9,38	72,9	2010	2x6	15,3	15*	35	61	3 x 350	230V-1	660	195	0,79	5,96
DPA 034C	8,28	12,2	65,2	3040	2x8	13,6	15*	35	62	4 x 350	230V-1	660	195	0,79	7,84
DPA 044C	8,52	12,5	97,2	2680	2x7	20,4	22*	35	62	4 x 350	230V-1	660	195	0,79	7,84

Multiple injection via * Küba-CAL® distributor

** Modification of sound power level, see page 59

Q_v - diagram (R22, R134A, R404A, R507)

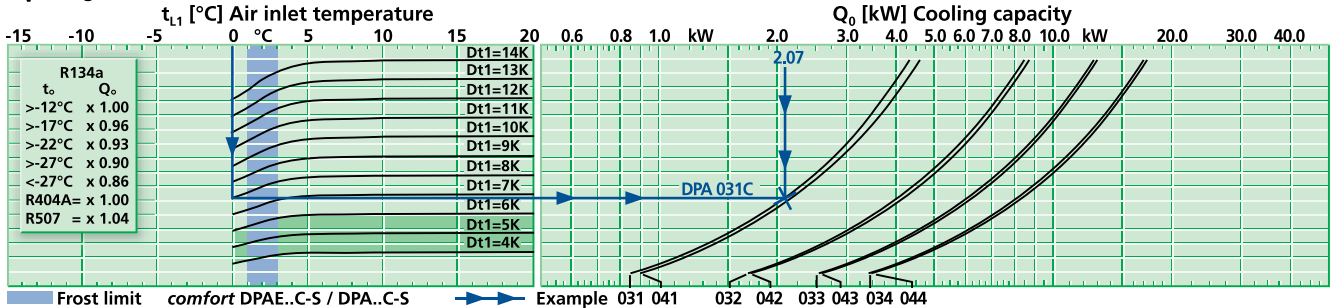

The technical data are also given in the product selection software.

**Available for
CO₂-DX
up to 54 bar**



Technical data

DPB(E)...C Normal Speed N

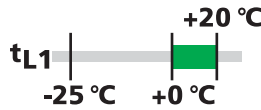

Model	Rating Q ₀ at 50 Hz DT1, R404A		Surface m ²	Air flow m ³ /h	Air throw m	Tube volume dm ³	Connections		Sound L _{WA} dB(A)	Blade St. x Ø mm	Fans (Operating values at 50 Hz)			Electr. defrost kW	
	t _{li} ±0 °C DT1 = 8K	t _{li} +10 °C DT1 = 10K					Inlet Ø mm	Outlet Ø mm			Type of current 230±10% V-1 50/60Hz	Per Fan min ⁻¹ W A			
DPB 031C	2,98	4,37	11,0	1850	2x11	3,4	10*	22	74	1 x 350	230V-1	1320	185	0,72	2,30
DPB 041C	3,72	5,46	16,4	1770	2x9	5,1	10*	22	74	1 x 350	230V-1	1320	185	0,72	2,30
DPB 032C	5,96	8,75	22,0	3700	2x12	6,8	10*	28	77	2 x 350	230V-1	1320	185	0,72	4,14
DPB 042C	7,44	10,9	32,8	3540	2x10	10,2	10*	28	77	2 x 350	230V-1	1320	185	0,72	4,14
DPB 033C	8,94	13,1	33,0	5550	2x13	10,2	10*	28	79	3 x 350	230V-1	1320	185	0,72	5,96
DPB 043C	11,2	16,4	49,2	5310	2x11	15,3	15*	35	79	3 x 350	230V-1	1320	185	0,72	5,96
DPB 034C	11,9	17,5	44,0	7400	2x14	13,6	15*	35	80	4 x 350	230V-1	1320	185	0,72	7,84
DPB 044C	14,9	21,8	65,6	7080	2x12	20,4	22*	35	80	4 x 350	230V-1	1320	185	0,72	7,84

Q_v - diagram (R22, R134A, R404A, R507)

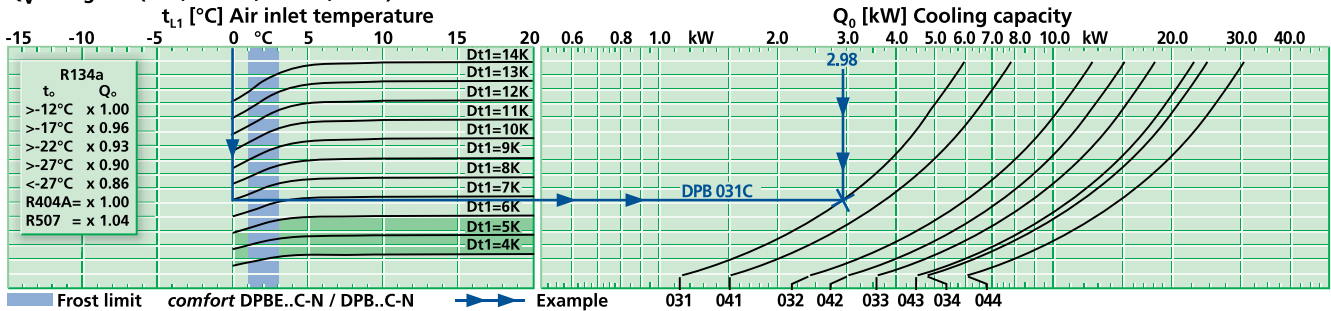

Technical data

DPB(E)...C Quiet Speed L



Model	Rating Q ₀ at 50 Hz DT1, R404A		Surface m ²	Air flow m ³ /h	Air throw m	Tube volume dm ³	Connections		Sound L _{WA} dB(A)	Blade St. x Ø mm	Fans (Operating values at 50 Hz)			Electr. defrost kW	
	t _{li} ±0 °C DT1 = 8K	t _{li} +10 °C DT1 = 10K					Inlet Ø mm	Outlet Ø mm			Type of current 230±10% V-1 50/60Hz	Per Fan min ⁻¹ W A			
DPB 031C	2,40	3,52	11,0	1300	2x8	3,4	10*	22	64	1 x 350	230V-1	930	195	0,79	2,30
DPB 041C	2,74	4,02	16,4	1140	2x5	5,1	10*	22	64	1 x 350	230V-1	930	195	0,79	2,30
DPB 032C	4,80	7,04	22,0	2600	2x9	6,8	10*	28	67	2 x 350	230V-1	930	195	0,79	4,14
DPB 042C	5,48	8,04	32,8	2280	2x6	10,2	10*	28	67	2 x 350	230V-1	930	195	0,79	4,14
DPB 033C	7,20	10,6	33,0	3900	2x10	10,2	10*	28	69	3 x 350	230V-1	930	195	0,79	5,96
DPB 043C	8,22	12,1	49,2	3420	2x7	15,3	15*	35	69	3 x 350	230V-1	930	195	0,79	5,96
DPB 034C	9,60	14,1	44,0	5200	2x11	13,6	15*	35	70	4 x 350	230V-1	930	195	0,79	7,84
DPB 044C	11,0	16,1	65,6	4560	2x8	20,4	22*	35	70	4 x 350	230V-1	930	195	0,79	7,84

Q_v - diagram (R22, R134A, R404A, R507)

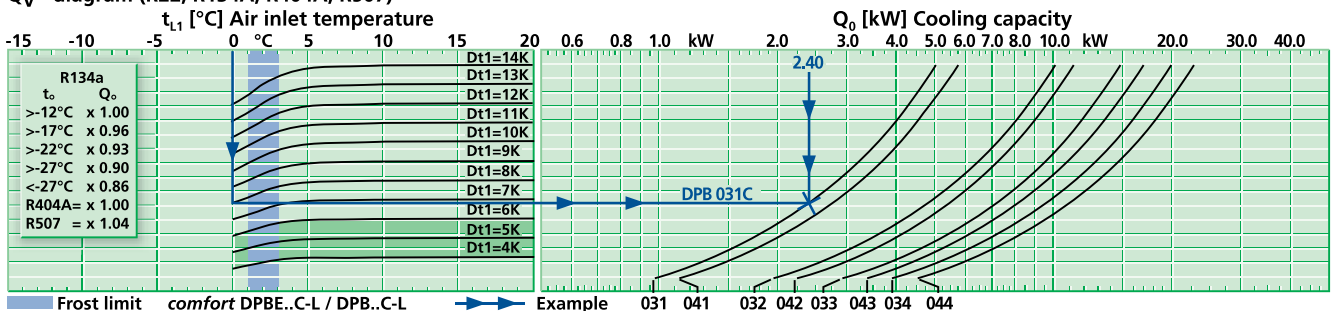



Technical data

DPB(E)...C Very quiet Speed S

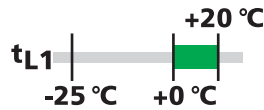

Model	Rating Q ₀ at 50 Hz DT1, R404A		Surface m ²	Air flow m ³ /h	Air throw m	Tube volume dm ³	Connections		Sound L _{WA} dB(A)	Blade St. x Ø mm	Fans (Operating values at 50 Hz)				Electr. defrost kW
	t ₁ ±0 °C DT1 = 8K	t ₁ +10 °C DT1 = 10 K					Inlet Ø mm	Outlet Ø mm			Type of current 230V±10% V-1 50/60Hz	Per Fan min ⁻¹	W	A	
DPB 031C	1,75	2,57	11,0	810	2x5	3,4	10*	22	56	1 x 350	230V-1	660	195	0,79	2,30
DPB 041C	2,13	3,13	16,4	800	2x4	5,1	10*	22	56	1 x 350	230V-1	660	195	0,79	2,30
DPB 032C	3,50	5,14	22,0	1620	2x6	6,8	10*	28	59	2 x 350	230V-1	660	195	0,79	4,14
DPB 042C	4,26	6,25	32,8	1600	2x5	10,2	10*	28	59	2 x 350	230V-1	660	195	0,79	4,14
DPB 033C	5,25	7,70	33,0	2430	2x7	10,2	10*	28	61	3 x 350	230V-1	660	195	0,79	5,96
DPB 043C	6,39	9,38	49,2	2400	2x6	15,3	15*	35	61	3 x 350	230V-1	660	195	0,79	5,96
DPB 034C	7,00	10,3	44,0	3240	2x8	13,6	15*	35	62	4 x 350	230V-1	660	195	0,79	7,84
DPB 044C	8,52	12,5	65,6	3200	2x7	20,4	22*	35	62	4 x 350	230V-1	660	195	0,79	7,84

Multiple injection via * Küba-CAL® distributor

** Modification of sound power level, see page 59

Q_v - diagram (R22, R134A, R404A, R507)

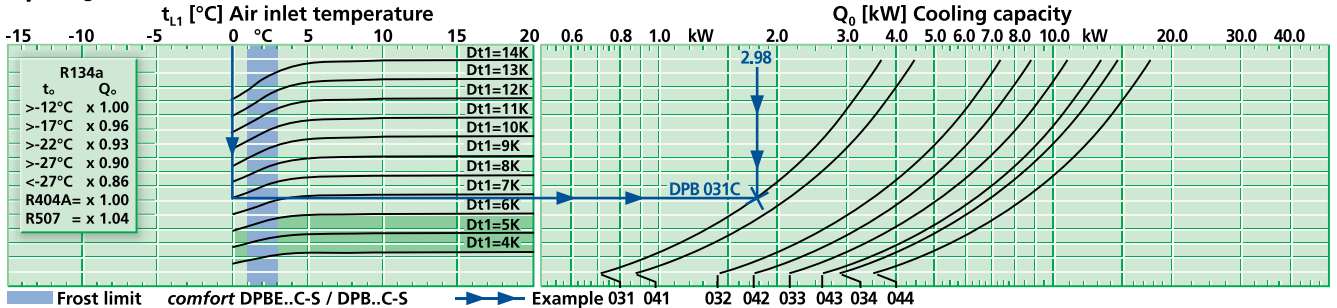

The technical data are also given in the product selection software.

**Available for
CO₂-DX
up to 54 bar**



Dimensions and weights

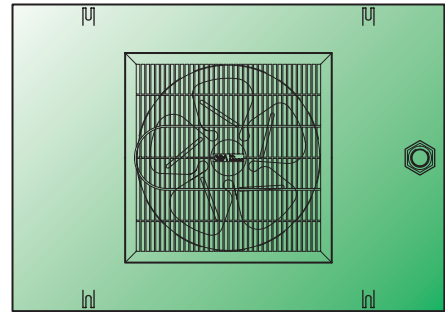
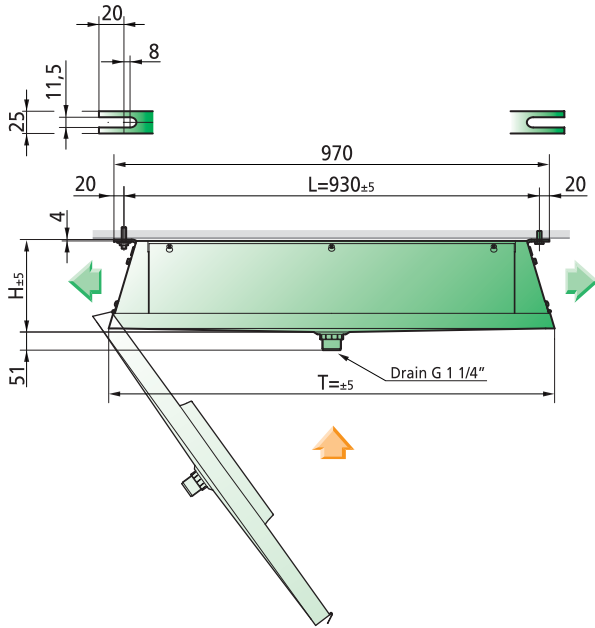

DP.(E) 031, 041 C

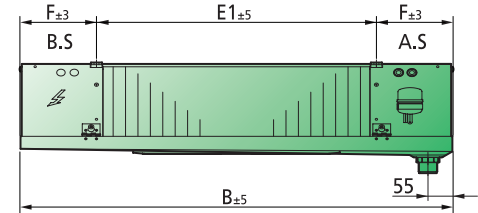

DP.(E) 032, 042 C

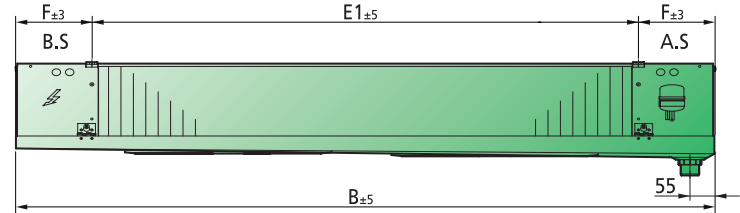

DP.(E) 033, 043 C

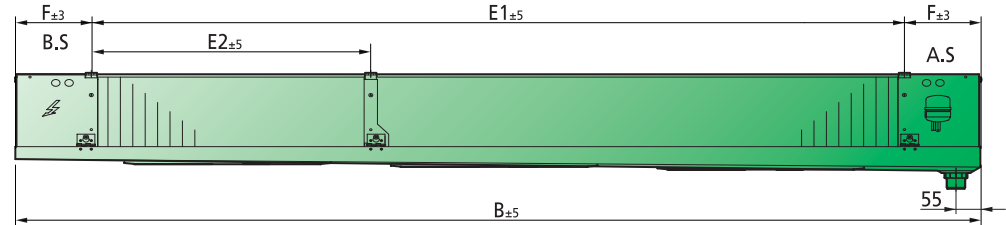

DP.(E) 034, 044 C

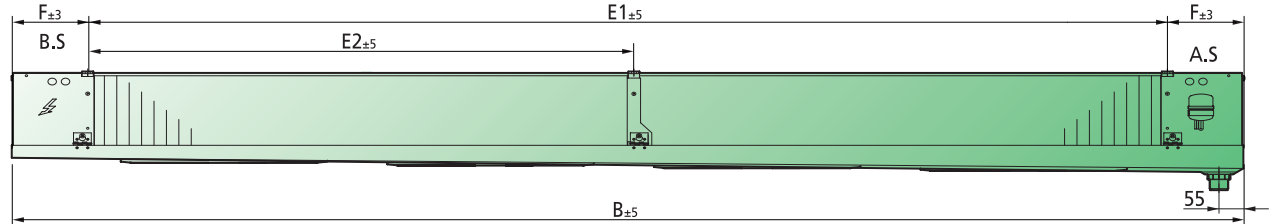

Model	Dimensions (mm)							Weight (net)		Weight (gross)	
	H	B	T	L	E ₁	E ₂	F	DPA.C kg	DPB.C kg	DPA.C kg	DPB.C kg
DP. 031C	281	972	1010	930	630	-	171	42,5	42	67	66,5
DP. 041C	281	972	1010	930	630	-	171	46,5	46	71	70,5
DP. 032C	288	1572	1010	930	1230	-	171	68,5	66	102,5	100
DP. 042C	288	1572	1010	930	1230	-	171	76,5	70	110,5	104
DP. 033C	296	2172	1010	930	1830	629	171	94,5	97	139,5	142
DP. 043C	296	2172	1010	930	1830	629	171	106	104	151	149
DP. 034C	303	2772	1010	930	2430	1229	171	122,5	117,5	175,5	170,5
DP. 044C	303	2772	1010	930	2430	1229	171	141	127	194	180

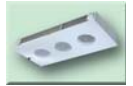

Variants and Electrical radiators

Alternating current motor, 1-speed

- Version .V1.02 230 V ±10 %, V-1, 50 / 60 Hz, adjustable

Motor label data 50 / 60 Hz

DP:	DP. 031 – 044 C
Fan:	Ø 350
Index of protection:	IP44
I (A):	0,62 / 0,86
P (W):	140 / 195
n (min):	1390 / 1550
C (µF):	5

Water/brine circulation

- Version .V2.05
Large number of distributors (small pressure drop)
- Version .V2.06
Small number of distributors (large pressure drop)

Connections for brine / water operation

Please use our Küba selection software for configuring the brine Air Coolers. Do not hesitate to contact us if you have any further questions.

For Cooler	Inlet and Outlet	
	.V2.05	.V2.06
DP. 031C	Ø 22	Ø 22
DP. 041C	Ø 22	Ø 22
DP. 032C	Ø 28	Ø 22
DP. 042C	Ø 28	Ø 22
DP. 033C	Ø 28	Ø 22
DP. 043C	Ø 28	Ø 22
DP. 034C	Ø 28	Ø 28
DP. 044C	Ø 35	Ø 28

Configuration

- Soldered connections
- Ventilation and drainage

Corrosion protection

- Version V6.01

Cooler:

Tubing:	Cu
Fins:	Al „goldlack“ coating
End plates:	Al, anti-corrosion paint coating on both sides

Casing:

Top Panel: Al or Sendzimir zinc-plated steel, anti-corrosion paint coating on both sides

- Version V6.04

Cooler:

Tubing:	Cu
Fins:	Al „goldlack“ coating
End plates:	Al

Casing:

Top Panel: Al, anti-corrosion paint coating

Insulated drip tray

- Version .V3.09

Insulation prevents condensation formation on the underside of the tray and reduces the transfer of defrosting heat into the cooling rooms.

Area of application

- Foodstuffs industry, e.g. butchering rooms

Electrical radiator

Configuration

- Electrical tubular radiator with CrNi jacket Ø 8,5 mm
- Connection impervious to water vapour, 1,0 mm² x 1000 mm acc. to VDE 0700 / part 1
- Aluminium fin
- Sendzimir zinc-plated end, middle and top plates
- Copper tube bush
- Completely powder-coated

Model	Nominal power at 230 V		Dimensions			Weight
	kW	A	H	L	kg	
DPHR 600	0,96	4,2	210	600	1,7	
DPHR 1200	1,91	8,3	210	1200	2,9	
DPHR 1800	2,87	12,5	210	1800	4,2	
DPHR 2400	3,75	16,3	210	2400	5,6	

Model	Piece	Model	Electrical radiator at 230V ± 10%, V-1 Connected load per Air Cooler	
			kW	A
DP031, 041C	2	DPHR 600	1,92	8,4
DP032, 042C	2	DPHR 1200	3,82	16,6
DP033, 043C	2	DPHR 1800	5,74	25,0
DP034, 044C	2	DPHR 2400	7,50	32,6



Accessories

Speed switch operation

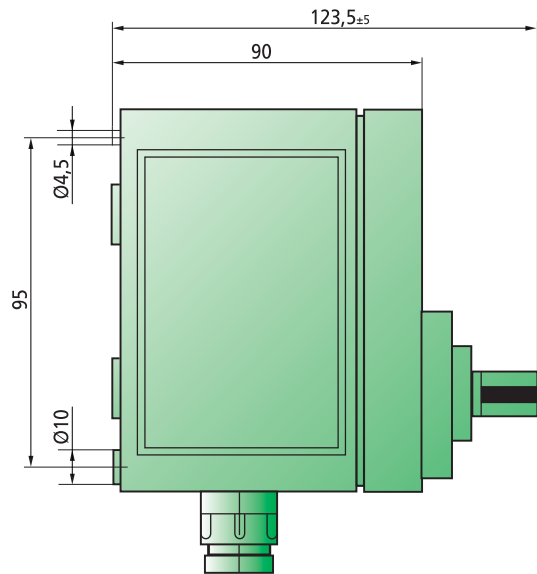
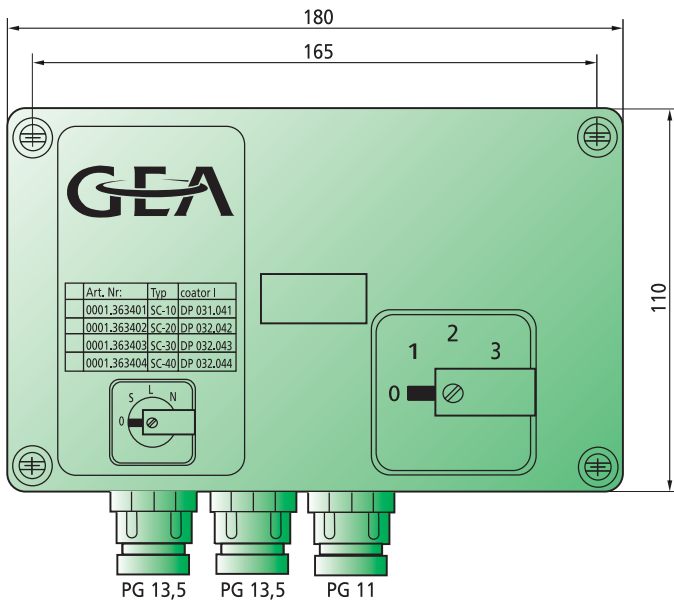

Model	for	Index of protection
SC-10**	DP 031C, 041C	⊕ IP 54
SC-20**	DP 032C, 042C	⊕⊕ IP 54
SC-30**	DP 033C,043C	⊕⊕⊕ IP 54
SC-40**	DP 034C, 044C	⊕⊕⊕⊕ IP 54

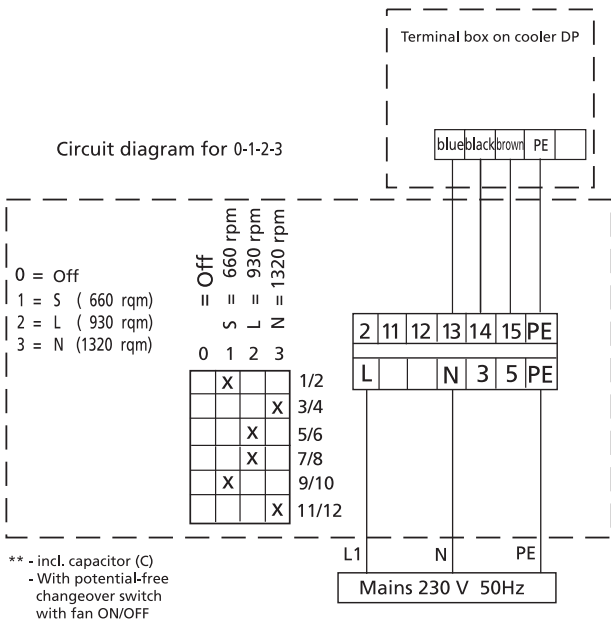

Model	for	Index of protection
C-10	DP 031C, 041C	⊕ IP 54
C-20	DP 032C, 042C	⊕⊕ IP 54
C-30	DP 033C,043C	⊕⊕⊕ IP 54
C-40	DP 034C, 044C	⊕⊕⊕⊕ IP 54

